



MAPEGUARD WP SYSTEM

Waterproofing membrane
with anti-fracture properties

TECHNICAL MANUAL





**WATERPROOFING MEMBRANE
WITH ANTI-FRACTURE PROPERTIES,
A QUICK AND EASY SYSTEM FOR INSTALLING
CERAMIC TILES, NATURAL STONE AND LVT.**

TABLE OF CONTENTS



Mapeguard WP System Waterproofing membrane with anti-fracture properties

- What is Mapeguard WP System2
- Advantages of the system 4
- Where to use..... 6
- System components and complementary accessories..... 8
 - Characteristics of system components 9
- Application procedure.....17
 - Preparing the substrate18
 - Applying **Mapeguard WP System**.....19
 - Method A..... 20
 - Method B 30
 - Applying profiles for floor-level showers36
 - Installing coverings.....38
 - Grouting40
 - Sealing..... 42
 - Cleaning and maintaining44
- Complementary accessories of **Mapeguard WP System** 46
 - Linear drains.....46
 - Point drainage56
 - Shower profiles.....58
- Waterproofing critical points..... 70
 - Waterproofing through-pipes..... 70
 - Repairing a tear.....72
 - Under-threshold waterproofing.....74
 - Sealing existing holes75
- Technical details76

What is Mapeguard WP System

The installation standards UNI 11493-1 and UNI 11714-1 define the performance characteristics that substrates must have for the installation of ceramic tiles or stone coverings.

If substrates are not properly prepared, they can negatively affect the correct laying.

For this reason, the creation of an adequate waterproofing system for the substrate is fundamental to guarantee a high-quality and long-lasting result.

Mapeguard WP System offers a rapid, simple installation and provides a waterproofing barrier in wet areas where ceramic tiles, stone material or LVT are needed. The surfaces can be quickly put into service and the system's ease minimizes potential installation errors.

Mapeguard WP System is a system consisting of a waterproofing membrane with anti-fracture properties, **Mapeguard WP 200**, and other accessory products to ensure complete and continuous waterproofing of surfaces.

The membrane consists of a flexible, thin, polyethylene waterproofing layer coated on both sides with a polypropylene non-woven fabric, which allows the application of ceramic tiles, stone material and LVTs. Please refer to the **Shower System 4 LVT¹** system technical data sheet for the installation of LVTs.

The polyethylene layer ensures the waterproofing of the system, while the polypropylene layer ensures a high adhesive capacity of the adhesive between membrane-support and membrane-coating.

The system is ETA certified according to ETAG 022* and AbP (Ü) certified.

Contact **Mapei Technical Services for further information.*



Advantages of the system



Waterproofing



Anti-fracture properties

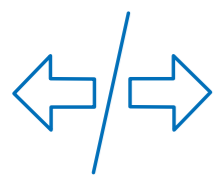

High tensile strength

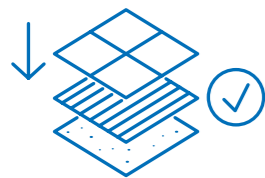

High adhesion with cement adhesives thanks to non-woven fabric



Easy to cut due to special membrane layout

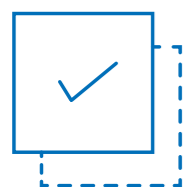

Easy to apply



Quick application



Suitable for immediate tiling

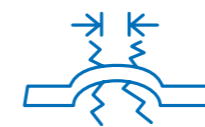

Crack bridging properties



Alkali-resistant



Hygienic

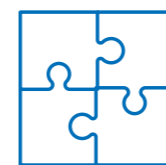

Complete system

Where to use

Mapeguard WP System consists of a membrane that can be used:

- as a **waterproofing membrane for damp environments**, in residential and commercial buildings, as well as in domestic and hotel bathrooms, in showers or in wellness spas;
- as an **anti-fracture membrane** under ceramic and stone floorings;
- as a **waterproofing membrane on moisture-sensitive substrates** (such as gypsum plaster, gypsum boards, calcium sulphate screeds) **and mineral surfaces** (such as cement plaster, porous concrete, concrete, cement screeds, fibre cement panels).



System components and complementary accessories



N°	DESCRIPTION	PRODUCT
1	Mapei adhesive with minimum C2 or R2 class according to EN 12004 depending on the type of substrate	For example: Adesilex P9 (C2TE) Keraflex Extra S1 ZERO (C2TES1, C2ES1) Ultralite S1 Flex ZERO (C2TES1) Keraquick Maxi S1 (C2FTS1) Ultrabond Eco Pu 2K (R2T)
2	Waterproofing membrane with anti-fracture properties	Mapeguard WP 200
3	Two-component, rapid-drying elastic cementitious adhesive	Mapeguard WP Adhesive
4	Waterproofing strip	Mapeguard ST
5	Waterproofing corner profile for internal / external corner	Mapeguard IC / Mapeguard EC
6	Waterproofing corner profile for floors of different height	Mapeguard DH-U
7	Waterproofing gasket for pipes and through-drains	Mapeguard PC
8	Shower profile with a slope for finishing sloping surface*	Glass Profile GPS4
9	Front shower profile for sloping surface*	Glass Profile GPS5
10	Shower profiles to be installed between the tiled sloped floor and the glass wall*	Glass Profile GPS1
11	Shower profiles to be installed between the tiled wall and the glass wall*	Glass Profile GPS2
12	Drain*	PP Drain Aqua

* Profilpas shower systems complementary products. For further information see www.profilpas.com



Characteristics of system components

Mapeguard WP 200

Waterproofing membrane with anti-fracture properties and alkali-resistant, for indoor use, it allows the installation of ceramics, natural stone tiles and LVT flooring.



Product specifications

Material	three layers: one in polyethylene and two in polypropylene
Colour	blue
Total thickness of the three layers (mm)	approx. 0.44-0.48
Polyethylene layer thickness (mm)	0.2
Width (cm)	100
Length (m)	30 and 5
Weight (g/m ²)	approx. 251-266
Vapour permeability	Sd > 100 m (vapour barrier according to UNI 11470)
Packaging	30 m x 1 m and 5m x 1 m rolls

CHECK THE
TECHNICAL
DATASHEET
on mapei.com





Characteristics of system components

Mapeguard WP Adhesive

Two-component, rapid-drying elastic cementitious adhesive for bonding and sealing overlaps of **Mapeguard WP System**.



Product specifications

Consistency	comp. A powder - comp. B liquid
Density of mix	1350 kg/m ²
Pot life of mix	approx. 45 min
Packaging	6.65 kg tanks (component A 3.5 kg + component B 3.15 kg)

CHECK THE
TECHNICAL
DATASHEET
on mapei.com



Mapeguard ST

Waterproofing strip for sealing edges and joints between **Mapeguard WP 200** sheets.



Product specifications

Material	three layers: one in polyethylene and two in polypropylene
Colour	blue
Width (cm)	12
Length (m)	30 and 10
Packaging	10 m x 12 cm and 30 m x 12 cm rolls

CHECK THE
TECHNICAL
DATASHEET
on mapei.com





Characteristics of system components

Mapeguard IC

Corner profile for waterproofing internal corners.

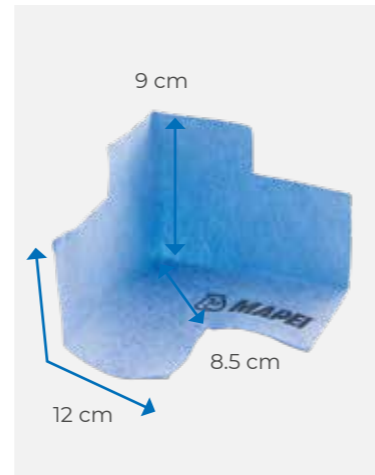

Product specifications

Material	three layers: one in polyethylene and two in polypropylene
Colour	blue
Dimensions (cm)	12/12/8.5-9
Packaging	25 pieces boxes

CHECK THE
TECHNICAL
DATASHEET
on mapei.com



Mapeguard EC

Corner profile for waterproofing external corners.

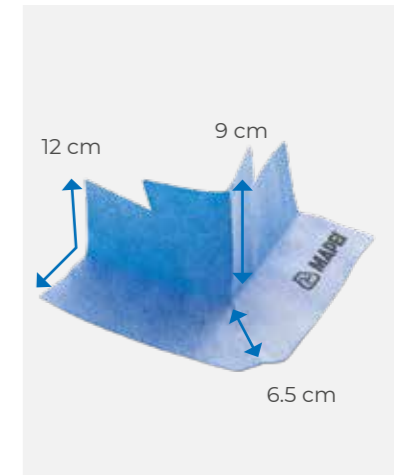

Product specifications

Material	three layers: one in polyethylene and two in polypropylene
Colour	blue
Dimensions (cm)	12/12/9-6.5
Packaging	25 pieces boxes

CHECK THE
TECHNICAL
DATASHEET
on mapei.com





Characteristics of system components

Mapeguard DH-U

Corner profile for waterproofing elements at different heights.



Product specifications

Material	three layers: one in polyethylene and two in polypropylene
Colour	blue
Height difference (mm)	15, 20, 28
Packaging	1 piece

Mapeguard PC

Flexible gaskets for waterproofing around pipes and passing-through drainage systems. Suitable for several pipe-diameters.



Product specifications

Material	three layers: one polyethylene and two polypropylene + rubber gasket
Colour	blue and black
Dimensions (mm)	10-24 / 15-38 / 28-50 / 50-75 / 75-110 / 100-130
Packaging	25 pieces boxes

CHECK THE
TECHNICAL
DATASHEET
on mapei.com



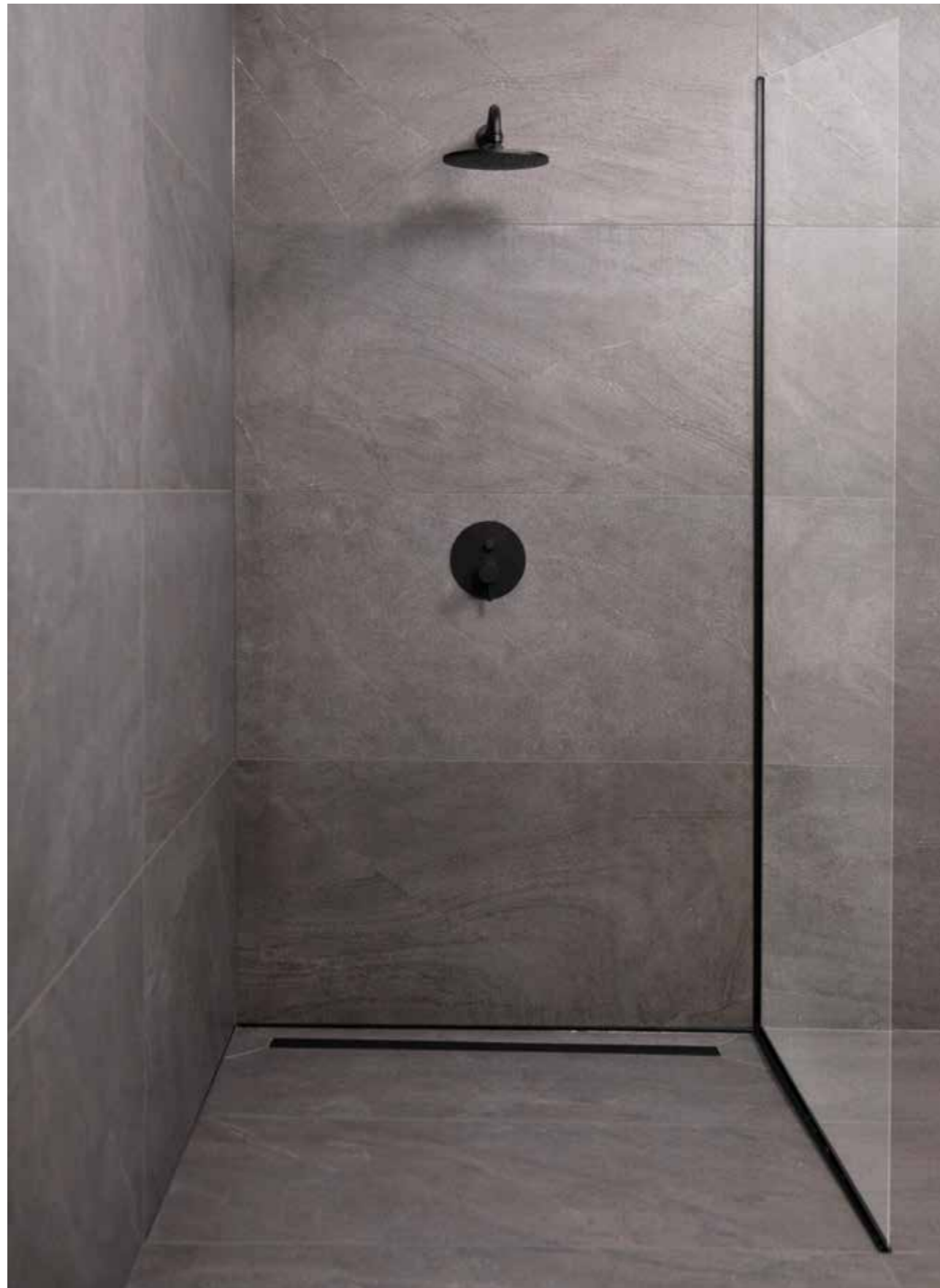

Application procedure

The correct application of **Mapeguard WP System** is essential to ensure a continuous waterproofing barrier through all the elements that make up the system, paying particular attention to the most critical points such as joints, slope changes, passing-through-pipes and drains.



Application procedure

Preparing the substrate

Before laying **Mapeguard WP System**, a suitable substrate must be created or the existing substrate must be checked and, if necessary, prepared to make it suitable for laying.

UNI 11493-1 and UNI 11714-1 indicate the minimum requirements that substrates must meet.

Regardless of the type, at the time of installation the substrates must be intact, with adequate mechanical strength, cured, clean, dry, flat, and free of all substances that could compromise adhesion. Remove any cement laitance, grease, oil, paint, wax, etc.

Cracks wider than 0.2 mm must be repaired with **Eporip** or **Eporip Turbo**.

Uneven cement substrates or ceramic surfaces with wide joints must be levelled before applying **Mapeguard WP 200** with suitable levelling products or thixotropic smoothing compounds, such as **Ultraplan Contract** or **Planitop Fast 330**.

Existing floors and ceramic tiled floors must adhere firmly to the substrate and be free from substances that may affect the adhesion of the membrane, such as grease, oil, paint, wax. Remove such substances by cleaning the floor with suitable products such as **UltraCare HD Cleaner**.

Non-absorbent substrates such as ceramic tiles or stone material must be primed with **Eco Prim T Plus** or **Eco Prim Grip Plus**.



Applying Mapeguard WP System

Mapeguard WP System can be applied to cement screeds and renders, using two methods, A and B.

Method A - Involves creating a continuous and complete waterproofing system by applying all the elements that make up the **Mapeguard WP System**. Adjacent sheets of **Mapeguard WP 200** are overlapped and their joints and edges are waterproofed using **Mapeguard ST** strip. Internal and external corners are waterproofed with **Mapeguard IC/Mapeguard EC** corner profiles. Use a **Mapei** adhesive of at least class C2 according to EN 12004 for membrane installation and **Mapeguard WP Adhesive** for applying the strip and corner profiles.

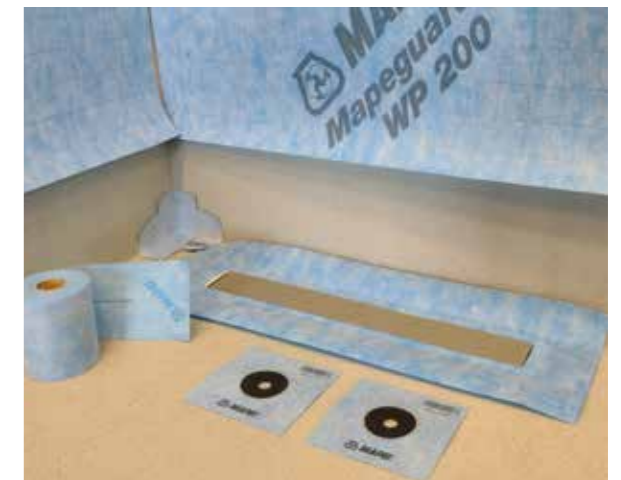

Method B - Consists of laying **Mapeguard WP 200** membrane with **Mapeguard WP Adhesive** making overlaps of at least 5 cm between adjacent sheets, and then using the same membrane to make all joints, edges and corners, as an alternative to applying **Mapeguard ST** and **Mapeguard IC/Mapeguard EC**.

This is a quick method since only the membrane is needed to waterproof the surface and critical points, using only **Mapeguard WP Adhesive**.

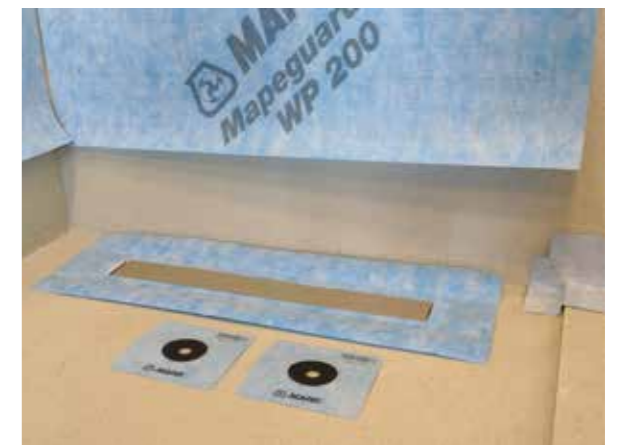

RECOMMENDATIONS

- Do not use **Mapeguard WP System** at temperatures below +5°C.
- In large areas, the use of **Mapeguard WP System** as an anti-fracture membrane does not eliminate the need for control joints.
- **Mapeguard WP System** cannot be left exposed but must be tiled with ceramic tiles or stone material.
- Follow all applicable national regulations and guidelines.
- Do not apply a skim coat to the surface of the waterproofing membrane.

Application procedure

Applying Mapeguard WP System: method A

The application of **Mapeguard WP System** to cementitious screeds and plasters is described below. **Mapeguard WP System** can generally be applied to substrates such as cement-based screeds and renders, concrete, fibre cement boards, heating screeds, existing floors, wooden substrates, metal surfaces.

Please refer to the 'Preparing the substrate' section on page 18 for the different substrates.

1 Applying PP Drain Aqua linear shower drain for floor-level showers

Before proceeding with the application of **Mapeguard WP System** and the creation of the screed, proceed with the correct installation of the drain. **Mapeguard WP System** can be installed in combination with complementary accessories such as **Profilpas** drains for floor-level showers **PP Drain Aqua**, **Thin Drain**, **Slim Drain**, **Smart Drain**, or drain pipes from the **Q Drain** range. For more details about **Profilpas** drains and pipe drains, please see page 48 or website www.profilpas.com.

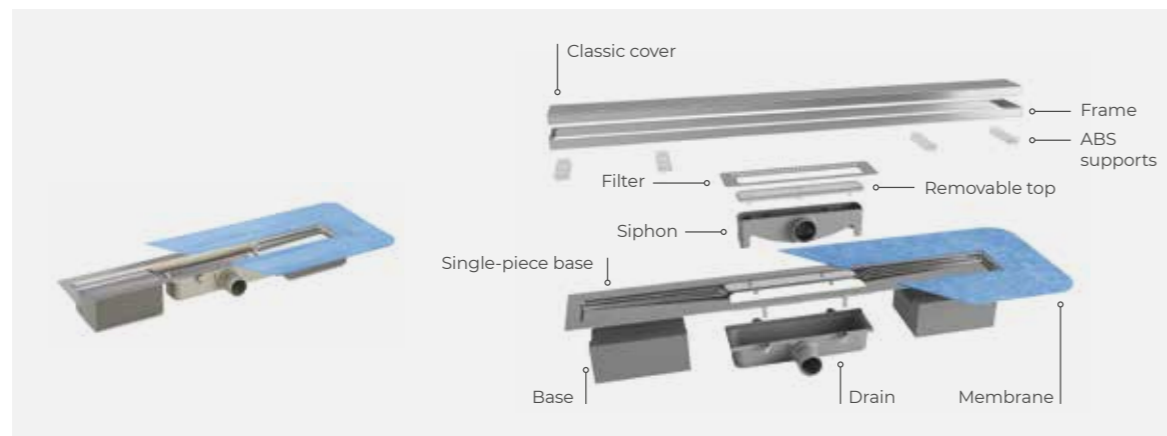

2 Defining dimensions and taking proper measurements

Determine the finished floor levels, allowing for the necessary slopes for water drainage. Take measurements for the correct positioning of the drain.



3 Placing the drain bases and body at the desired location

Using a spirit level, level the drain by adjusting its height. Keep the patch of the waterproofing membrane closed until bonding in the following stages.



4 Connecting the drain siphon to the drainage system

The sewage pipe must have been laid with the correct slope. Carry out a leak test on the shower drainage pipe /drain to verify proper functionality and ensure there are no water leaks.



5 Creating the cement screed

Ensure that the empty spaces under the drain are filled with **Topcem Pronto**. Proceed with the screed creation using **Topcem Pronto**, ensuring a 2% slope in the shower area to allow water to flow towards the drain.



6 Measuring and cutting Mapeguard WP 200 membrane

Before bonding, unroll and cut the membrane to size according to the geometry of the room to be waterproofed and the possible presence of perimeter walls, drains, through-pipes, etc. The membrane can be cut using simple tools such as scissors or a cutter. The special **Mapeguard WP 200** layout facilitates cutting thanks to the dashed lines every 5 cm. Cut the sheets of membrane by making holes at through-pipes and make a U-cut at the drain. At these points (through-pipes, drains, ducts) make sure to avoid joints of adjacent sheets.



7 Applying the adhesive for bonding Mapeguard WP 200

Spread the adhesive onto the substrate using a suitable notched trowel (e.g., 3 mm or 4 mm notched trowel). Use **Mapei** improved-adhesion adhesives of minimum C2 class in accordance with EN 12004 or ISO 13007 (such as **Adesilex P9**, **Keraflex Extra S1 ZERO**, **Ultralite S1 Flex ZERO**, **Keraquick Maxi S1**).



8 Laying Mapeguard WP 200 on the floor

Lay the membrane over the fresh adhesive. Press down evenly, from the centre towards the edges, to avoid air bubbles forming under the waterproofing membrane and remove any excess adhesive that may leak out from the edges. Adjacent sheets of **Mapeguard WP 200** are to be laid side by side.



9 Laying Mapeguard WP 200 on the wall

Proceed with waterproofing the walls using the same procedure as for the floor.



10 Bonding the waterproofing membrane of the drain

- A.** Apply **Mapeguard WP Adhesive** by brush (or 3 mm notched trowel or roller) around the drain, for an area corresponding to the width of the drain's membrane.
- B.** Open the waterproofing membrane of the drain, press it down evenly with a squeegee to release any air bubbles present and ensure complete wetting of the back.
- C.** During the subsequent application stages, keep the protective cover closure in place to prevent material from entering the drain itself.

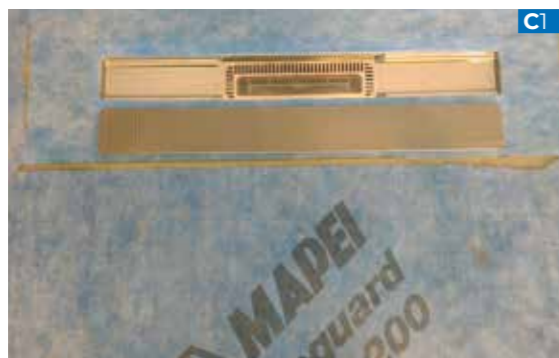

11 Waterproofing the corner of the staggered patterns

In the case of floor-level showers, uneven level is usually created between the sloping surface of the inside of the shower and the zero level surface of the outside of the shower. At this critical point, apply the side corner for the waterproofing elements at different heights **Mapeguard DH-U**. Bond it with **Mapeguard WP Adhesive**, applied with a brush (or 3 mm notched trowel or roller) and then press down evenly with a suitable trowel. **Mapeguard DH-U** is available in several sizes, depending on the height difference between the two levels.



12

Waterproofing corners

Waterproof the inside/outside corners with **Mapeguard IC / Mapeguard EC** bonded with **Mapeguard WP Adhesive**, applied by brush (or 3 mm notched trowel or roller), and then press down evenly with a suitable trowel.



13

Waterproofing joints and edges between adjacent Mapeguard WP 200 sheets

- A. After waterproofing all corners, proceed with waterproofing the joints and edges between adjacent sheets. Apply **Mapeguard WP Adhesive** by brush (or 3 mm notched trowel or roller) and apply **Mapeguard ST** strip pressing it down evenly with a suitable trowel in order to waterproof:
 - B. the edges between the wall and the floor;
 - C. the edges between wall and wall;
 - D. the edges between staggered surfaces;
 - E. joints between adjacent sheets of **Mapeguard WP 200**.
- F. For waterproofing between adjacent sheets of **Mapeguard WP 200**, as an alternative to the application of the strip, adjacent sheets of at least 5 cm width may be overlapped sealing the overlaps with **Mapeguard WP Adhesive** applied by brush (or 3 mm notched trowel or roller).





14 Waterproofing through-pipes

Waterproof the pipes and through-elements with **Mapeguard PC** gaskets bonded with **Mapeguard WP Adhesive**, applied by brush (or 3 mm notched trowel or roller) on the membrane. Press them down evenly with a suitable trowel. **Mapeguard PC** gaskets are available in different diameters to be chosen according to the through-hole.



15 Verifying the correct application of Mapeguard WP System

Once **Mapeguard WP System** has been applied, check that the entire surface is completely waterproofed even in critical areas. In high traffic conditions, it is recommended to protect **Mapeguard WP System** surface with wood panelling, before proceeding with the covering. Once the installation of **Mapeguard WP System** has been completed, it is possible to immediately lay the covering, even if the adhesive used with the membrane is still fresh.



Application procedure

Applying Mapeguard WP System: method B

The technical characteristics of **Mapeguard WP 200** membrane allow it to be easily folded so that it can be used to waterproof edges, corners and joints between adjacent sheets by overlapping them.

This solution is an alternative to the application method shown in the previous chapter.

1 Applying the drain and creating the screed

Proceed as described in **application method A in steps 1 to 5**. Create the screed with the correct slope and check the correct arrangement of **Profilpas** shower drain.



2 Bonding the waterproofing membrane of the drain

Apply **Mapeguard WP Adhesive** around the drain by brush (or 3 mm notched trowel or roller). Open the waterproofing membrane of the drain and press it down evenly with a suitable trowel to release any air bubbles present and ensure complete wetting of the back. During the subsequent application stages, keep the protective closing cover in place to prevent material from getting inside.



3 Measuring and cutting Mapeguard WP 200 membrane

Before bonding, unroll and cut the membrane to size according to the geometry of the room to be waterproofed and the possible presence of perimeter walls, drains, through-pipes, etc. The membrane can be cut using simple tools such as scissors or a cutter. The special layout of the membrane facilitates cutting thanks to the dashed lines every 5 cm. Cut the sheets of the membrane by making holes at through-pipes and make a U-cut at the drain. At these points (through-pipes, drains, ducts) make sure to avoid joints of adjacent sheets. When measuring and cutting the membrane, allow an extra 5 cm from the edges to make overlaps between adjacent sheets.



4 Applying the adhesive for bonding Mapeguard WP 200

Apply **Mapeguard WP Adhesive** by roller on the wall and floor substrate.

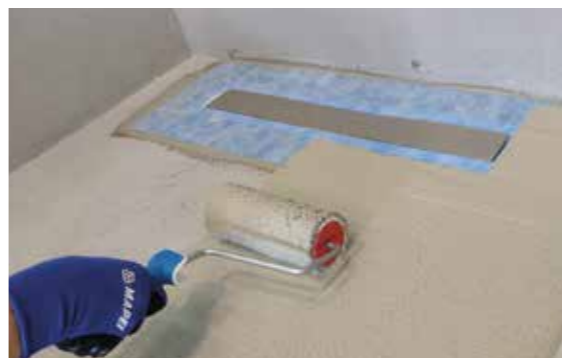

5 Laying Mapeguard WP 200 on the floor

Lay the membrane over the fresh adhesive.
Press down evenly, from the centre towards the edges, to avoid air bubbles forming under the waterproofing membrane and remove any excess adhesive that may leak out from the edges.
Overlaps between adjacent sheets of **Mapeguard WP 200** must be at least 5 cm wide and must be sealed with **Mapeguard Wp Adhesive**, applied by brush (or 3 mm notched trowel or roller).
The layout of **Mapeguard WP 200** membrane has dashed lines every 5 cm, which makes it easier to lay, particularly when making overlaps between adjacent sheets.



6 Laying Mapeguard WP 200 on the wall

Proceed with waterproofing the walls using the same procedure as for the floor.



7 Waterproofing wall-floor and wall-wall edges

Waterproof the edges between wall-floor and wall-wall by overlapping adjacent sheets of **Mapeguard WP 200** by at least 5 cm wide and sealing the overlap with **Mapeguard WP Adhesive**, applied by brush (or 3 mm notched trowel or roller).

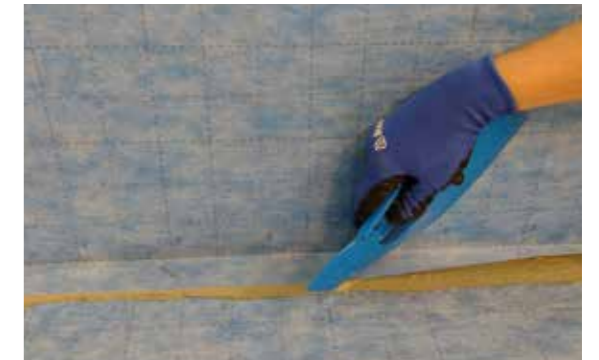

8 Waterproofing corners

It is possible to waterproof corners by folding **Mapeguard WP 200** membrane itself, without the use of accessories and without cutting. Apply **Mapeguard WP Adhesive** by brush to bond the folds of the membrane, thus creating the waterproofed corner.



9

Waterproofing the corner and edge at different heights

- A.** In the case of floor-level showers, different heights are usually created between the sloping plane of the inside of the shower and the zero level plane of the outside of the shower. At this critical point, apply **Mapeguard DH-U**, the corner profile for waterproofing elements at different heights, bonded with **Mapeguard WP Adhesive**, applied by brush (or 3 mm notched trowel or roller), and then press down evenly with a suitable trowel. **Mapeguard DH-U** is available in several thicknesses depending on the height difference.
- B.** Spread **Mapeguard WP Adhesive** by brush (or 3 mm notched trowel or roller) and apply **Mapeguard ST** strip to waterproof the edge between the different heights levels. Press the strip evenly with a suitable trowel.

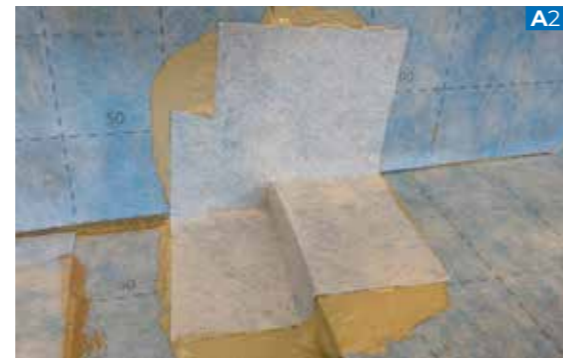

10

Waterproofing through-pipes

Waterproof the pipes and through-elements with **Mapeguard PC** gaskets bonded with **Mapeguard WP Adhesive**, applied by brush (or 3 mm notched trowel or roller) on the membrane. Press them down evenly with a suitable trowel. **Mapeguard PC** gaskets are available in different diameters to be chosen according to the through-hole.



Application procedure

Applying profiles for floor-level showers

Mapeguard WP System combined with the **Glass Profile** line of shower profiles allows the realisation of ceramic and stone wall coverings with a high aesthetic and functional value.

Glass Profile is the line of stainless steel profiles by **Profilpas** to create floor-level shower trays by covering the difference in level of the sloping surfaces with a 2% slope, thus enabling the creation of a coplanar surface with a modern, linear design. More details about **Profilpas** shower profiles can be found on page 58 or on www.profilpas.com.

Proceed with the application of the shower profiles before tiling.

1 Choosing the model, size and cutting of **Glass Profile** shower profiles

The profiles are available in different sizes depending on the thickness of the covering to be laid. The choice of the profile model depends on the type of floor-level shower: Walk-in shower, fully or partially enclosed shower, glass-enclosed shower.



2 Applying the adhesive for shower profile bonding

Apply **Mapei** adhesive of minimum C2 class in accordance with EN 12004 or ISO 13007. The adhesive to be used to apply the profiles is the same as the one used for installing the covering. The choice of the adhesive varies depending on the type and size of the coverings to be installed.



3 Applying **Glass Profile** shower profiles

- A.** Lay the shower profiles chosen according to the shower design on the fresh adhesive with a slight pressure so that the adhesive enters the shearing of the profile to facilitate mechanical bonding. Use a suitable trowel to spread the leaked adhesive to ensure complete wetting.
- B.** Apply the sloped **Glass Profile GPS4** shower profile provided with a 2% slope on the inner side of the shower, to join the sloping surface and the wall covering, thus eliminating the need for an oblique tile cut. Alternatively, in the case of open showers, apply the **Glass Profile GPS3**, provided with a 2% slope on the inner side of the shower, for the sloping surface sides.
- C.** Apply the front shower profile **Glass Profile GPS5** to be placed on the wall above the shower drain with a sloping surface to avoid cutting the tiles, thus completing the shower perimeter by joining the two profiles with a slope on the sides.
- D.** Apply the sloping **GPS1** shower profile provided on the inside of the shower with a 2% slope for the insertion of glass partition walls on the floor. The complementary **GPS/6** end cap completes the profile hiding visible section of the glass wall.
- E.** Apply **Glass Profile GPS2** shower profile for insertion of glass partition wall. The complementary **GPS/6** end cap completes the profile hiding visible section of the glass wall.



Application procedure

Installing coverings

Once the installation of **Mapeguard WP System** and **Glass Profile** shower profiles is complete, it is possible to proceed immediately with the installation of ceramic or stone material covering.

1 Selecting and applying the adhesive for tile installation

Install the tiles using a suitable **Mapei** adhesive of at least class C2 according to EN 12004 or ISO 13007, to be chosen based on the type and size of the ceramic tile or stone material and the ready for use-time. Use the double spreading technique to ensure proper wetting of the back of the tiles.



2 Applying the levelling system

- A. When laying tiles, in order to maintain the correct size of joints and to reduce any height differences between adjacent tiles, use levelling systems from the **MapeLevel** range and spacers from the **Mapei Tile Spacer** range.
- B. Position the spacer bases below the already laid tile. Select the number and type of spacer bases appropriate to the tile format and installation pattern, then install the adjacent tiles.
- C. Insert the cap or wedge, depending on the levelling system chosen, into the spacer base to achieve the desired levelling of the tiles.
- D. Once the adhesive is set, remove the levelling system by hitting the spacer bases with a rubber mallet (or with your foot) parallel to the grout line. Separate the disposable elements from the wedges/caps that can be reused for subsequent applications.



3 Installing coverings

In **PP Drain Aqua** drains, the 6 to 18 mm supports make it easy to adjust the height of the covers during the installation, depending on the thickness of the tiles. Install the tiles at a distance of approx. 3-4 mm from the edge of the drain.

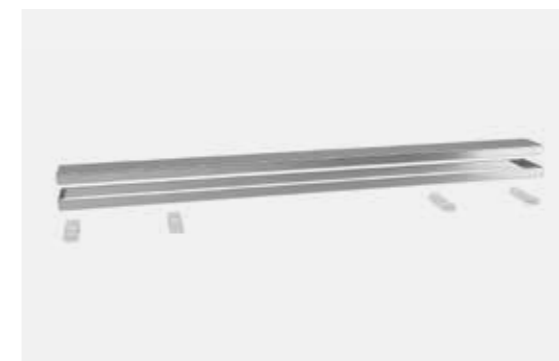

Application procedure

Grouting

Grout the tiles using cementitious mortar such as **Ultracolor Plus** or epoxy grouts such as **Kerapoxy Easy Design**.

1 Grouts preparing

Ensure that grouts are clean, free of dust and hollow for at least 2/3 of the tile thickness. If there are any adhesive residues, which may have flowed back during laying, they must be removed while still fresh or afterwards mechanically with cutters, abrasive scrapers, etc.



2 Grouting the coverings

Fill the joints with the chosen grout mixture using the rubber trowel without leaving gaps or unevenness.



3 Cleaning the grouts

With a small amount of water, first use an abrasive sponge (such as Scotch-Brite®) and then a cellulose sponge, working diagonally across the joints and taking care not to empty them.



4 End-of-laying cleaning

After grouting, use **UltraCare Keranet** or **UltraCare Keranet Easy** cleaners for cement grouts or **UltraCare Kerapoxy Cleaner** for epoxy grout to remove any dirt or fine grout residue.



Application procedure

Sealing

Carry out joint sealing with a sealant such as **Mapesil AC Eco** or **Mapesil Tile Matt** for ceramic tiles and **Mapesil LM** or **Mapesil Stone Matt** with stone material.

1 Applying the sealant

Apply sealant at expansion joints, perimeter joints and around the perimeter of the shower profiles and drain to ensure proper sealing of the joint.



2 Finishing

- A. After applying the sealant, before the surface film forms, spray **UltraCareSmooth Silicone** onto the joint to facilitate finishing and to achieve smooth, compact surfaces without voids that could otherwise form collection points for dirt and future mould formation.
- B. Refinish using a suitable tool such as **Perfect Seal**.



3 Applying the transparent silicone glazing bead gasket

Glass Profile GG silicone gaskets available in various sizes complete the **Glass Profile** range and are to be used as glazing beads in profiles that require them.



Application procedure

Cleaning and maintaining

UltraCare line offers a complete range of cleaning, protective and complementary products formulated to be safe to use and easy to apply, meeting the need to clean, protect and maintain surfaces over time while safeguarding performance and aesthetics.

Mapei offers a range for end-of-lay cleaning and routine or extraordinary maintenance of different types of surfaces such as **UltraCare Keranet**, **UltraCare Acid Cleaner**, **UltraCare Kerapoxy Cleaner**, **UltraCare Multicleaner**, **UltraCare HD Cleaner**; protective products such as **UltraCare Stain Protector W** and **UltraCare Intensifier W**; products for cleaning, protecting and renewing grout lines such as **UltraCare Grout Cleaner**, **UltraCare Grout Protector**, **UltraCare Fuga Fresca**; products for removing or protecting surfaces against mould formation such as **UltraCare Deep Cleaner** and **UltraCare Deep Protector** and products to be used after toning treatments and/or oil and water repellents such as **UltraCare Finish Lucida** and **UltraCare Finish Opaca**.

More information on the complete **UltraCare** product line can be found at www.mapei.com



To facilitate the maintenance of linear floor-level drains and drainage points, the **Profilpas** gully and drain siphon can be inspected and in some models is easy to remove, making ordinary and extraordinary cleaning quick and effective.

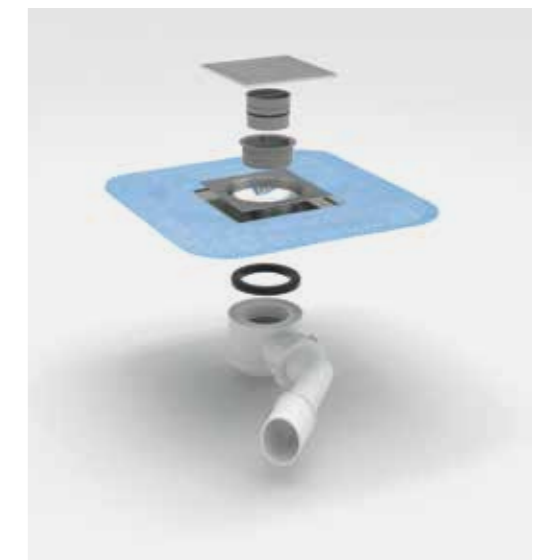
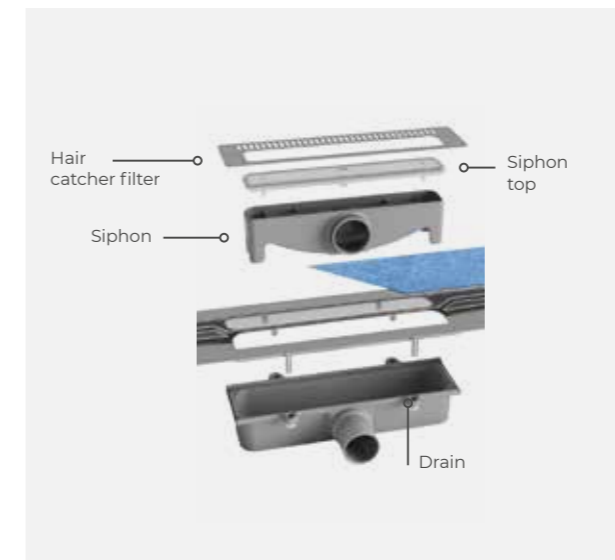

In **PP Drain Aqua** drains, a special key allows the filter to be lifted and the siphon effortlessly removed. In addition, the siphon of the **PP Drain Aqua** drains is made of antibacterial ABS to ensure maximum hygiene at all times.



Complementary accessories of Mapeguard WP System

Linear drains

Profilpas' shower systems include **PP Drain Aqua**, **PP Drain Aqua 360**, **Thin Drain**, **Slim Drain** and **Smart Drain**, a range of floor-level shower drains that can be customised with multiple types of covers, differing in design and finish: the ideal solution for transforming showers into a design space.

These solutions make it possible to eliminate traditional shower trays, creating a single surface of continuity with the bathroom floor. A choice that perfectly complements any type of floor covering, following the latest interior design trends.

PP Drain Aqua is a floor-level steel shower drain with a patented removable anti-bacterial ABS siphon. Available in a wide range of covers and finishes to suit every style. The **Thin Drain** drain is only 55 mm height while the **Slim Drain** is 65 mm height and only 48 mm width, making it particularly suitable for renovations. **Smart Drain**, with a height of 75 mm and a width of 77 mm, is ideal for use with large format tiles. All drains have a pre-bonded waterproofing membrane to prevent seepages and combine perfectly with **Mapeguard WP System** waterproofing system.

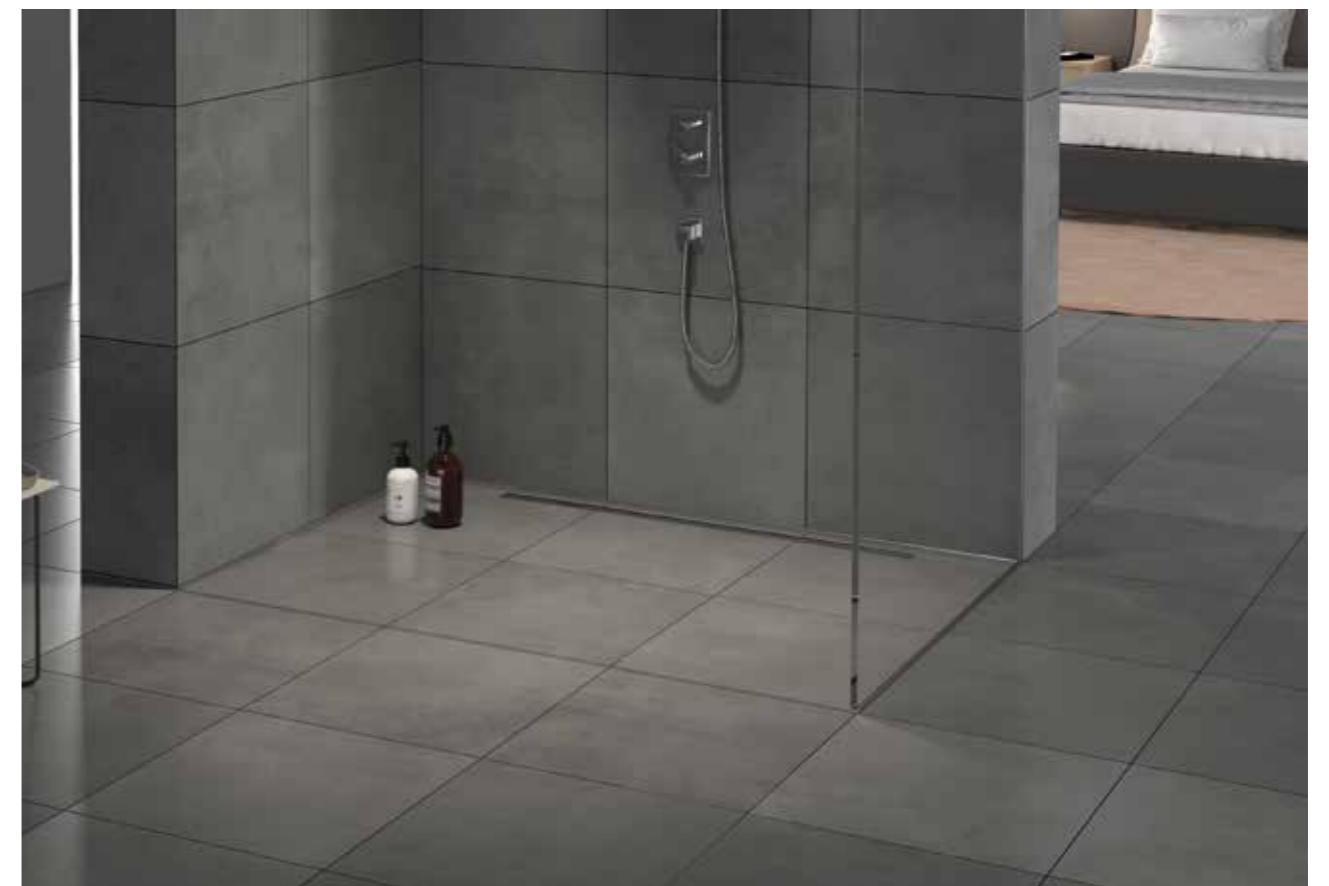



Linear drains

PP Drain Aqua

PP Drain Aqua is a line of floor-level shower drains suitable for ceramic tiles, natural stone or other floor coverings. **PP Drain Aqua** drains are made of AISI 316 stainless steel and have a wide choice of framed and frameless covers. All covers are suitable for wall thicknesses from 6 to 18 mm (except for **Invisible Cover** which is suitable for wall thicknesses of any thickness).

They are available with a DN40 horizontal outlet siphon (flow rate 50 litres/minute) or a DN50 direct vertical outlet. Drains fitted with a siphon have a flush-to-floor of 70 mm and a visible cover length of 60 to 120 cm. The drain body has a solidly bonded waterproofing membrane (compliant with DIN 18534), which ensures a perfect integration of the drain with the **Mapeguard WP System** shower area waterproofing system. The covers and the frame have special adjustment supports from 6 to 18 mm, and are also available in an invisible tilable version, for coverings of any thickness.

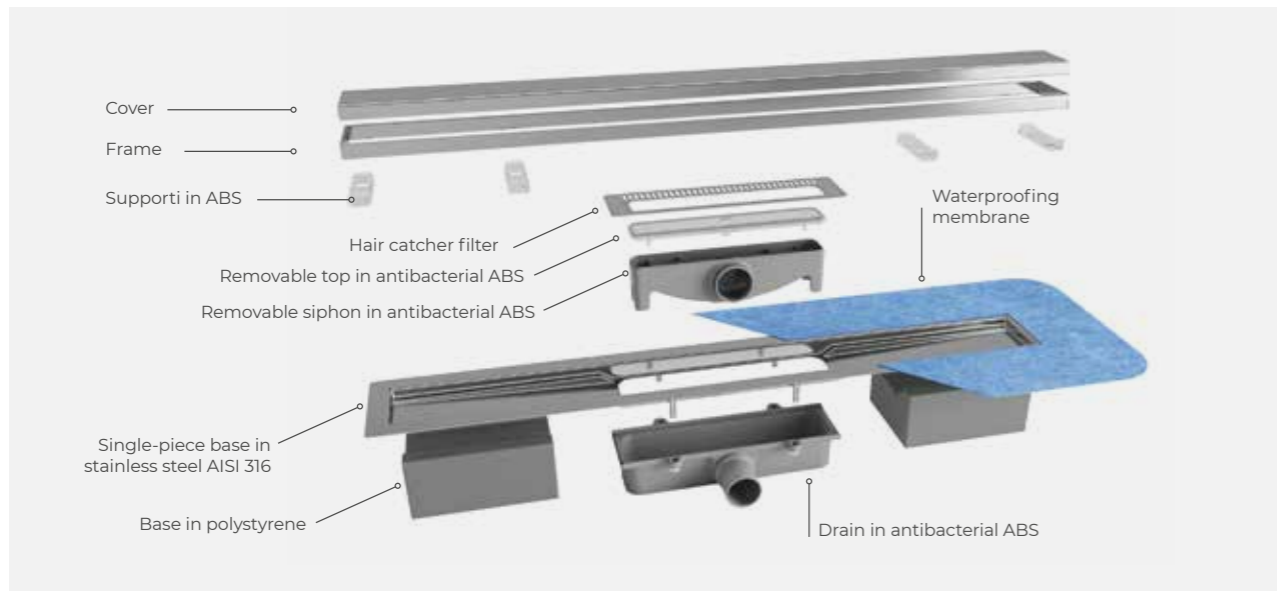

Shower drain base with siphon



Shower drain base with 360° swivelling siphon

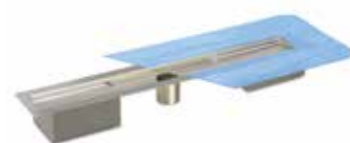

Shower drain base with direct drainage



Product specifications

Material	Stainless Steel AISI 316 - DIN 1.4404
Length (cm)	60, 70, 80, 90, 100 and 120
Floor-level size (mm)	70
Width (mm)	68
Packaging	1 piece



Linear drains

Thin Drain

Thin Drain drains are for floor-level showers suitable for ceramic tiles, natural stone or other coverings. They are made of moulded stainless steel and are suitable for wall coverings up to 12.5 mm thick. Featuring a horizontal drain towards the front, an integrated stainless steel odor-resistant siphon, and a flow rate of 26 liters/minute. These drains offer a reduced floor-level size DN/OD of 40 (40 mm) with a support height of 55 mm and visible lengths range from 60 to 120 cm. Equipped with two extruded polystyrene supports for accurate positioning, they also include a securely bonded sealing gasket (waterproof membrane) along the outer edge. This ensures seamless integration with the **Mapeguard WP System's** horizontal and vertical waterproofing, allowing for both central and lateral installation.

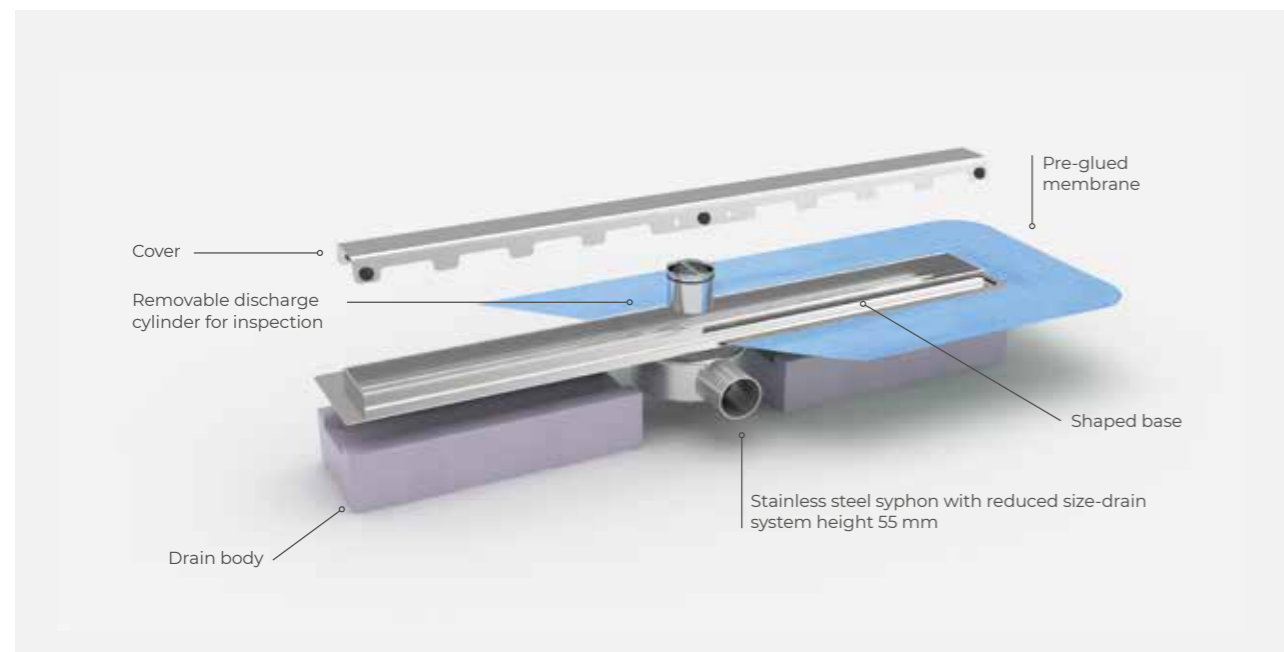

Product specifications

Structure material	Stainless steel AISI 304 - DIN 1.4301 V2A
Drainage siphon material	Stainless steel AISI 304 - DIN 1.4301
Length (cm)	60, 70, 80, 90, 100 and 120
Floor-level size (mm)	40
Support height (mm)	55
Width (mm)	57.6
Packaging	1 piece



Linear drains

Slim Drain

Slim Drain drains are designed to collect water in floor-level showers and are suitable for ceramic tiles, natural stone or other coverings. They are made of shaped stainless steel and equipped with an adjustable frame which can accommodate tile thicknesses from 7 to 12.5 mm with adjustment screws. With a horizontal drain towards the front and an integrated stainless steel odor-resistant siphon, they offer a flow rate of 32 liters/minute. The slim profile features a DN/OD of 40 (40 mm) and a support height of 65 mm, with visible lengths ranging from 60 to 120 cm. Integrated adjustment supports allow for leveling, and a securely bonded sealing gasket (waterproof membrane) along the outer edge ensures seamless integration with the **Mapeguard WP System's** horizontal and vertical waterproofing. This enables both central and lateral installation. **Slim Drain** drains are also available in an invisible version (recessed cover) that can be tiled with materials of any thickness.



Product specifications

Structure material	Stainless steel AISI 304 - DIN 1.4301 V2A
Drainage siphon material	Stainless steel AISI 304 - DIN 1.4301
Length (cm)	60, 70, 80, 90, 100 and 120
Floor-level size (mm)	40
Support height (mm)	65
Width (mm)	48
Packaging	1 piece



Linear drains

Smart Drain

Smart Drain drains are designed to collect water in floor-level showers and are suitable for ceramic tiles, natural stone, or other coverings. Constructed from shaped stainless steel and equipped with an adjustable frame, they can accommodate tile thicknesses from 7 to 12.5 mm with adjustment screws. Featuring a horizontal drain, an on-site assembly PP odor-resistant siphon, and a flow rate of 34 liters/minute, they offer a slim profile with a DN/OD of 40 (40 mm) and a support height of 75 mm.

Visible lengths range from 70 to 120 cm. Integrated adjustment supports allow for levelling, and a securely bonded sealing gasket (waterproof membrane) along the outer edge ensures seamless integration with the **Mapeguard WP System's** horizontal and vertical waterproofing. This enables both central and lateral installation. **Smart Drain** drains are also available in an invisible version (recessed cover) that can be tiled with materials of any thickness.

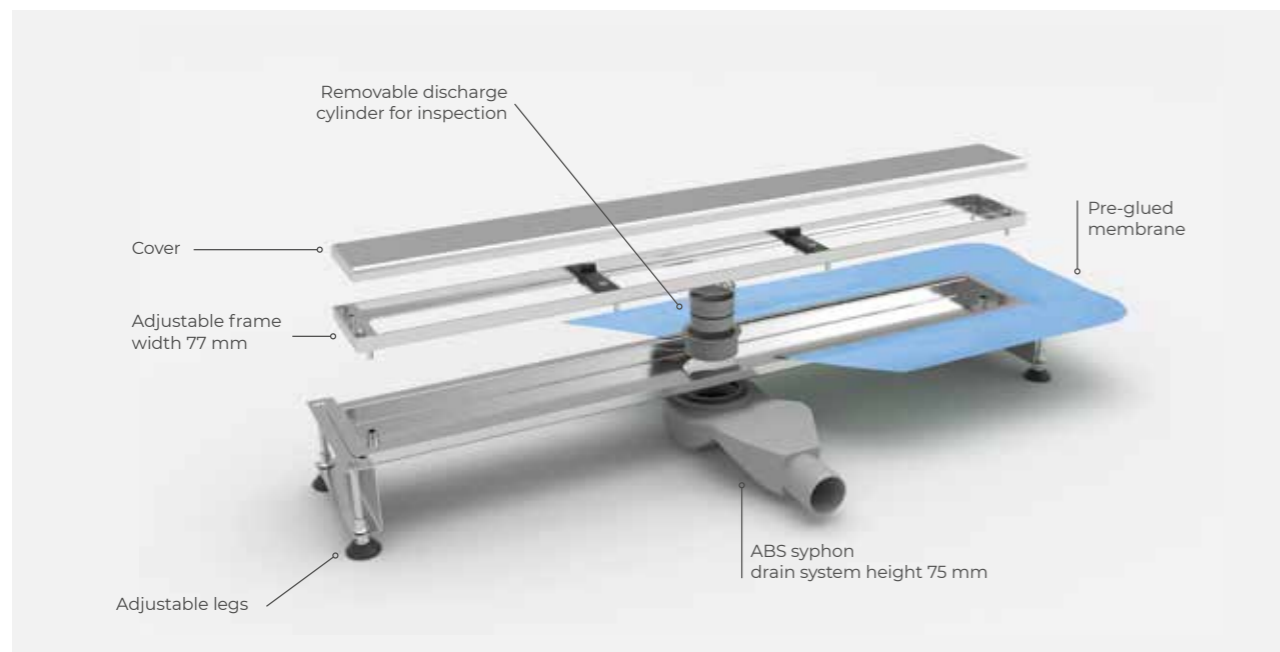

Product specifications

Structure material	Stainless steel AISI 304 - DIN 1.4301 V2A
Drainage siphon material	Highly resistant polypropylene
Length (cm)	70, 80, 90, 100, 110 and 120
Floor-level size (mm)	40
Support height (mm)	75
Width (mm)	77
Packaging	1 piece

Complementary accessories of Mapeguard WP System

Point drainage

Profilpas shower systems also include a **Q-Drain** line of point drainages for flush in floor-level shower suitable for ceramic tiles, natural stone or other coverings. The drains from the **Q-Drain** range are available in various models.



Point drainage

Q Drain

Q-Drain is a line of floor-level shower drainages suitable for showers with ceramic tiles, natural stone or other coverings. They are made of shaped stainless steel suitable for wall coverings up to 12.5 mm thick. With an horizontal drain, it has an odour trap made of PP to be installed on site with a flow rate 26 litres/minute. The flush floor size is DN/OD50 (50 mm) with a support height of 72/78 mm and an exposed dimension of 10x10 cm. They have a sealing plug (waterproof membrane) firmly bonded to the outer edge of the gullies. This connection guarantees perfect integration of the gullies with the **Mapeguard WP System** horizontal and vertical waterproofing system and allows them to be used in both central and lateral positions. **Q-Drain** are also available in the tile version (retractable cover) which can be tiled with materials up to a maximum thickness of 10 mm.

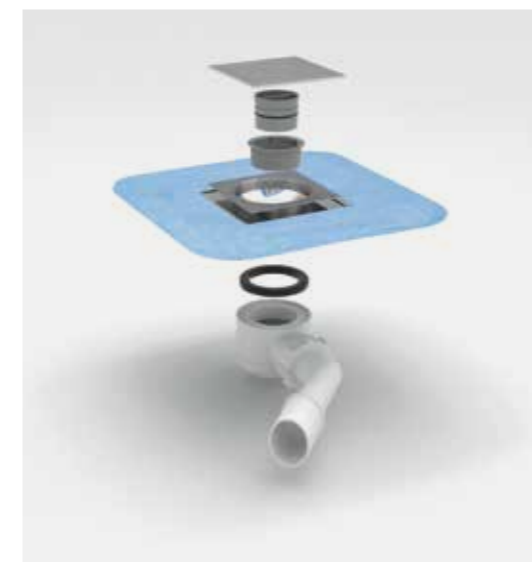

Q Drain Classic



Q Drain Cube



Q Drain Line



Q Drain Tile

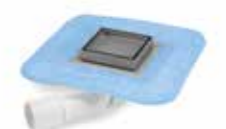

Product specifications

Structure material	Stainless steel AISI 304 - DIN 1.4301 V2A
Drainage siphon material	Highly resistant polypropylene
Dimensions (cm)	10x10
Floor-level size (mm)	50
Support height (mm)	72-78
Width (mm)	100
Packaging	10 pieces pack

Complementary accessories of the Mapeguard WP System

Shower profiles

Glass Profile is a line of stainless steel profiles that is part of the wide range of bathroom solutions offered by **Profilpas** and can be combined with the **Mapeguard WP System** waterproofing system.

The **Glass Profile** line for inserting glass walls and finishing the sloping surface allows for the precise configuration of floor-level showers. Designed to cover the sloping edges of the tiled shower tray with a 2% slope, it creates a coplanar surface and makes the perimeter of the shower area aesthetically perfect.

Glass Profiles solve all critical points such as edges, slopes and glass walls.

Available in lengths of 98, 120, 148 and 200 cm, in DX or SX versions, plus a front profile parallel to the shower drain, they are to be installed on site and allow many combinations to solve the design of any tiled shower environment.

Special end pieces are available to complete the profile to hide the visible section of the glass wall, and silicone gaskets of various sizes to be used as glazing beads in profiles where they are to be inserted.

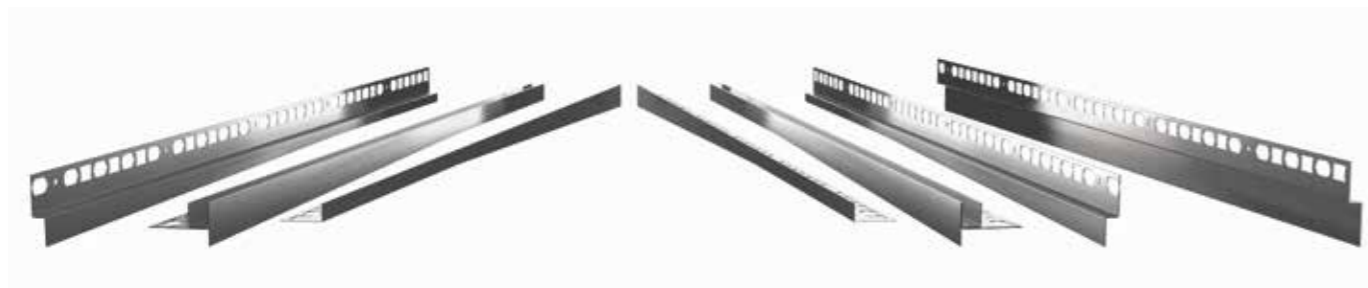

Glass Profile simplifies installation in various situations:

- **GPS1**: profiles to be installed between the tiled floor with a slope and the glass wall;
- **GPS2 - GPS14**: profiles to be installed between the tiled wall and the glass wall;
- **GPS3**: profiles to be installed between the sloping sides of open-space showers;
- **GPS4**: profiles to be installed between the tiled floor with a slope and the tiled side walls;
- **GPS5**: profiles to be installed between the tiled floor with a slope and the front tiled wall.

The range offers finishes in satin stainless steel and matte black painted steel.

They are suitable for:

- showers with glass walls;
- open-space showers;
- niches in shower.





Shower profiles

Glass Profile GPS1

Glass Profile GPS1 is a stainless steel profile for the insertion of glass walls of floor-level showers. It is provided with a 2% slope on the shower inner side for a perfect aesthetic solution of the sloped surface.

GPS/6, the end cap for hiding the section of the glass wall, completes the profile.

Silicone gaskets in various sizes complete the **Glass Profile** range and are to be used as glazing beads in profiles that include them.

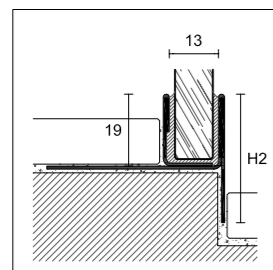

GPS1/SX

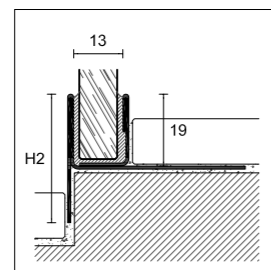

GPS1/DX

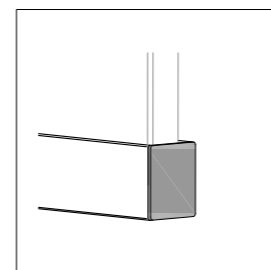

GPS/6



Product specifications

Material	Stainless steel AISI 304 DIN 1.4301
Length (cm)	98, 120, 148 and 200
Height (mm)	19
H2 Height (mm)	34, 37, 42 e 60
Finishes	Brushed stainless steel AISI 304 DIN 1.4301 Stainless steel AISI 304 DIN 1.4301 painted matt black RAL 9005
Packaging	5 pieces pack



Shower profiles

Glass Profile GPS2

Glass Profile GPS2 is an AISI 304 stainless steel profile for the insertion of glass separating walls of floor-level showers. It is suitable for tiles of any thickness and does not require drilling.

Glass Profile GPS/6 in combination, is the terminal to complete the profile, to hide the visible section of the glass wall.

Alternatively, **Glass Profile GPS14** is a stainless steel profile suitable for the insertion of glass walls and should be fixed directly onto the already laid coverings.

Silicone gaskets in various sizes complete the **Glass Profile** range and are to be used as glazing beads in profiles that include them.

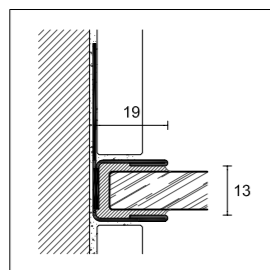

GPS2

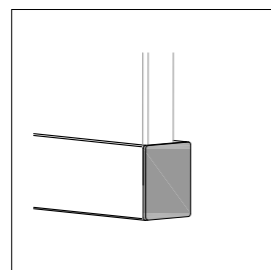

GPS/6

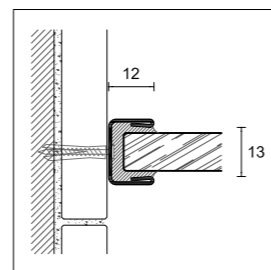

GPS14



Product specifications

Material	Stainless steel AISI 304 DIN 1.4301
Length (cm)	210 and 250
H Height (mm)	10, 12,5 and 19
Finishes	Brushed stainless steel AISI 304 DIN 1.4301 Stainless steel AISI 304 DIN 1.4301 painted matt black RAL 9005
Packaging	5 pieces pack



Shower profiles

Glass Profile GPS3

Glass Profile GPS3 is an AISI 304 stainless steel profile with a 2% slope on the inner side of the shower for an aesthetically perfect solution of the sloping surface sides.

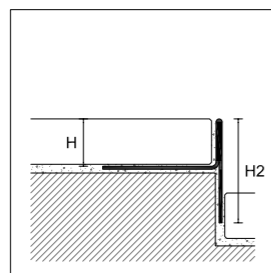

GPS3/SX

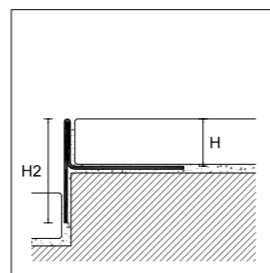

GPS3/DX



Product specifications

Material	Stainless steel AISI 304 DIN 1.4301
Length (cm)	98 and 120
H Height (mm)	10, 11 and 12,5
Finishes	Brushed stainless steel AISI 304 DIN 1.4301 Stainless steel AISI 304 DIN 1.4301 painted matt black RAL 9005
Packaging	5 pieces pack



Shower profiles

Glass Profile GPS4

Glass Profile GPS4 is an AISI 304 stainless steel profile with a 2% slope on the inside of the shower to solve the connection between the sloping surface and wall tile by eliminating the oblique cut of the tile.

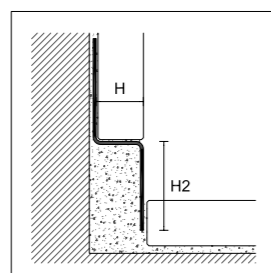

GPS4/SX

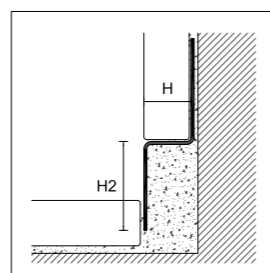

GPS4/DX



Product specifications

Material	Stainless steel AISI 304 DIN 1.4301
Length (cm)	98, 120, 148 and 200
H Width (mm)	10, 11 and 12,5
H2 Height (mm)	23, 26, 31 and 49
Finishes	Brushed stainless steel AISI 304 DIN 1.4301 Stainless steel AISI 304 DIN 1.4301 painted matt black RAL 9005
Packaging	5 pieces pack



Shower profiles

Glass Profile GPS5

Glass Profile GPS5 is an AISI 304 stainless steel profile to be placed on the wall, above the shower channel with a sloping surface, to avoid cutting the tiles to size. The profile aesthetically completes the perimeter of the floor-level shower.

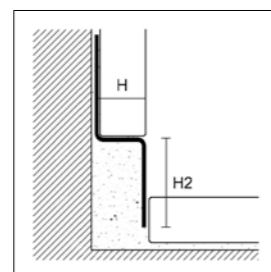

GPS5

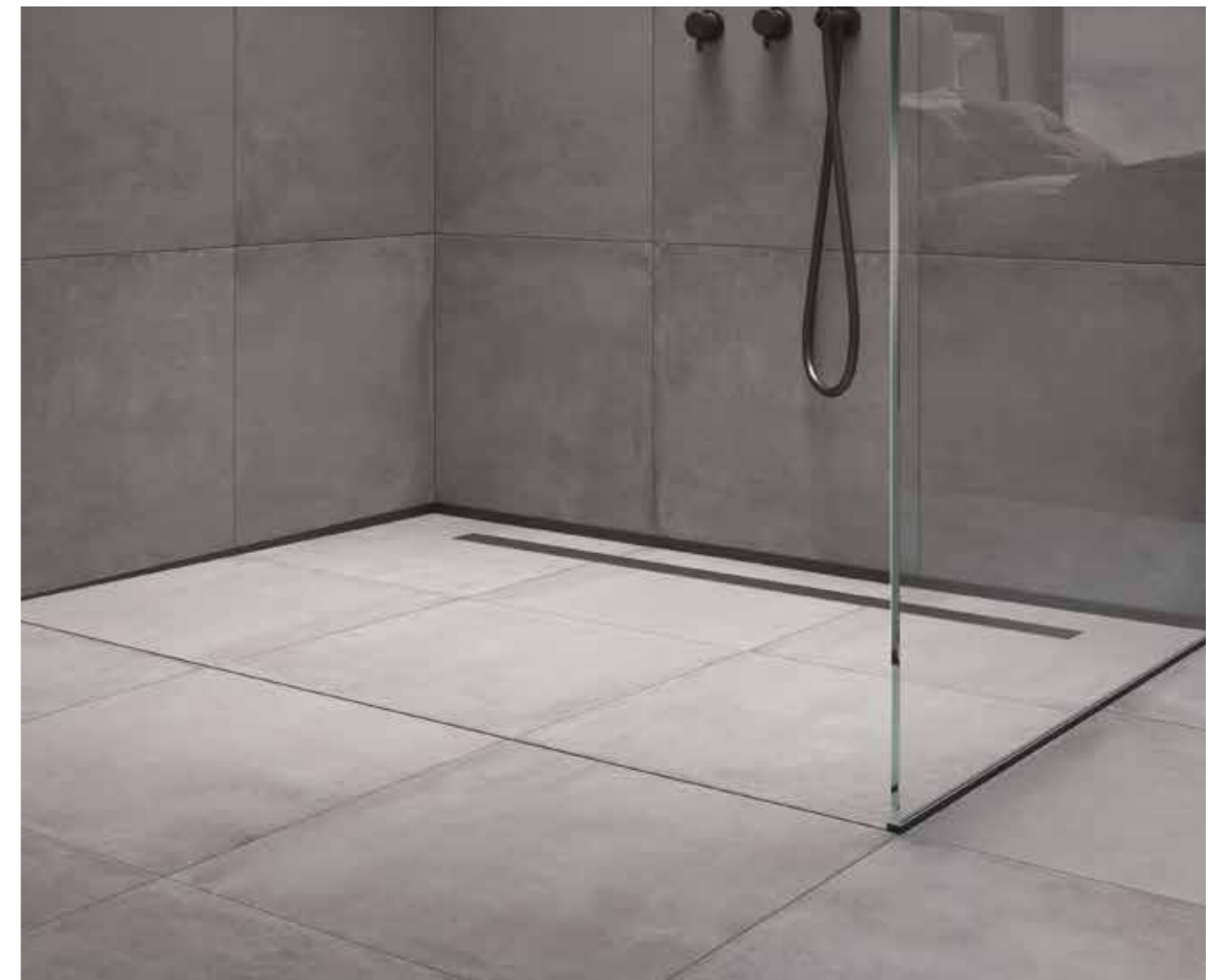

Product specifications

Material	Stainless steel AISI 304 DIN 1.4301
Length (cm)	125
H Width (mm)	10, 11 and 12,5
H2 Height (mm)	23, 33 and 45
Finishes	Brushed stainless steel AISI 304 DIN 1.4301 Stainless steel AISI 304 DIN 1.4301 painted matt black RAL 9005
Packaging	5 pieces pack

Waterproofing critical points

Waterproofing through-pipes

In order to carry out proper waterproofing, it is important not to neglect the waterproofing of critical points such as through-pipes, under-threshold joints.

1 Checking the pipes

Check that all pipes are correctly positioned, protrude at right angles from the floor or wall and that there is a maximum space of 2 mm between the wall or floor and the pipe. Larger holes must be sealed with **Mapeflex MS45**.



2 Choosing the proper gasket

Choose the correct size and properly bond **Mapeguard PC** with **Mapeguard WP Adhesive**. Make sure that the back of **Mapeguard PC** is completely wetted by the adhesive.

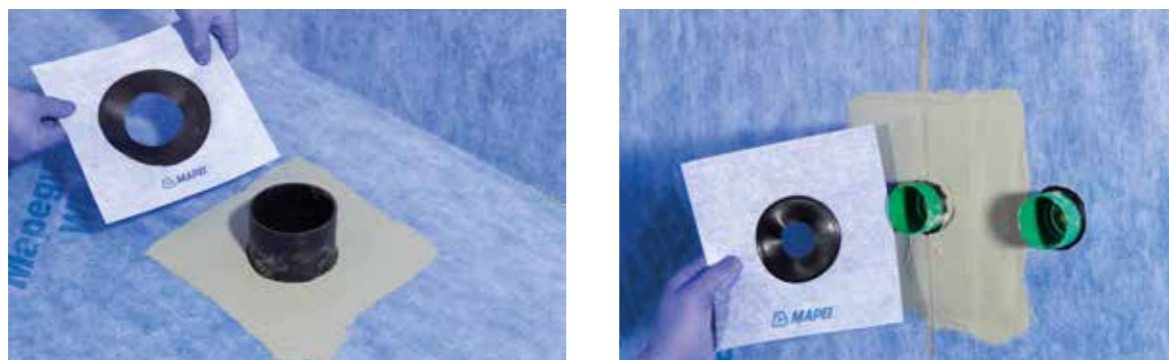

3 Pressing the gasket

Press **Mapeguard PC** so that no air bubbles form and remove any excess adhesive that may leak from the edges.



4 Sealing between pipe and gasket

Apply **Mapeguard WP Adhesive** where the gasket ring joins the pipe.

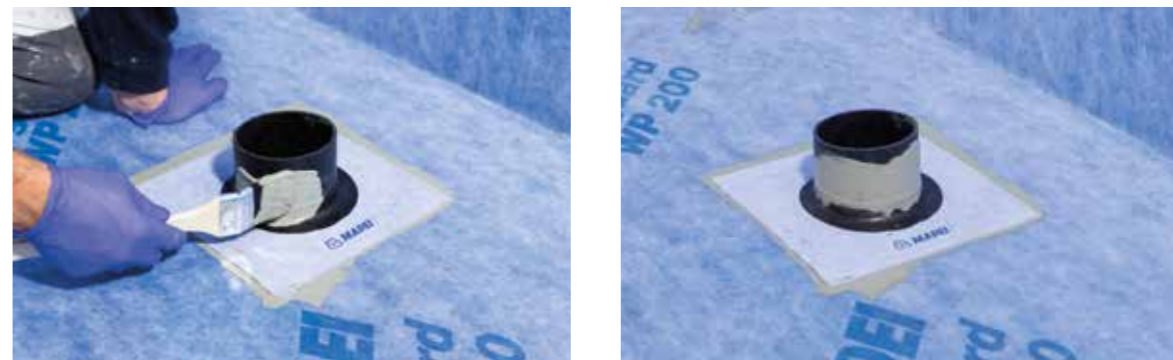

Waterproofing critical points

Repairing a tear

1

Choosing the proper material

Any tears in the **Mapeguard WP 200** membrane or any other element of the system can be easily repaired by using a piece of membrane or alternatively a piece of **Mapeguard ST** strip. This operation guarantees the continuity of the waterproofing.



2

Made-to-measure cutting

Cut a piece of **Mapeguard WP 200** or **Mapeguard ST** to size. Make sure that the piece completely covers the area of the tear and that there is at least 5 cm of membrane or band protrusion from the damaged area.



3

Applying the adhesive

Apply **Mapeguard WP Adhesive** to the damaged area to bond the cut piece of **Mapeguard WP 200** or **Mapeguard ST**.



4

Installing the repair

Glue the repair piece and press down evenly to prevent air bubbles from forming and remove excess adhesive that may leak from the edges. Make sure that the damaged area is completely covered.



Waterproofing critical points

Under-threshold waterproofing

For sub-threshold waterproofing, fold **Mapeguard WP 200** membrane up to the level of the pre-finished floor. Alternatively, use **Mapeguard ST** strip applied with **Mapeguard WP Adhesive**.

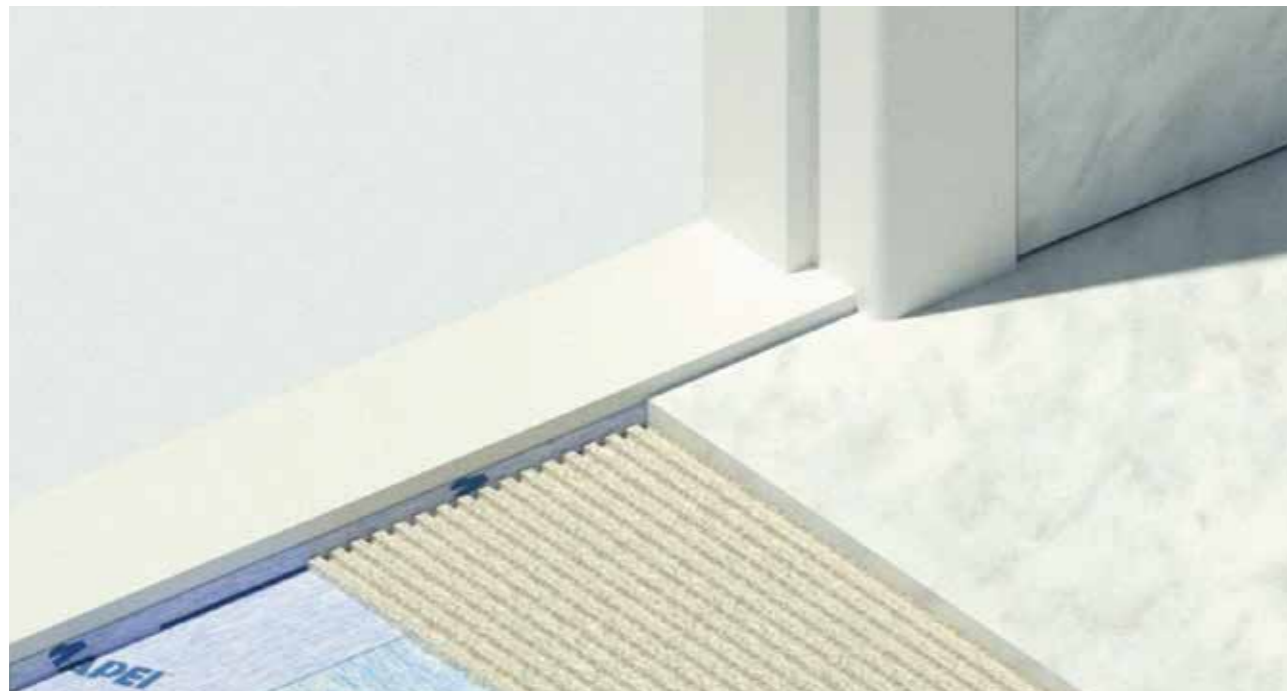

Sealing existing holes

Seal the existing holes by filling the wall plug and the hole with **Mapesil AC** sealant in the case of ceramic coverings or with **Mapesil LM** in the case of stone material.

Mapesil AC



Mapesil LM



Technical details

Mapeguard WP System

Waterproofing floor-level shower.

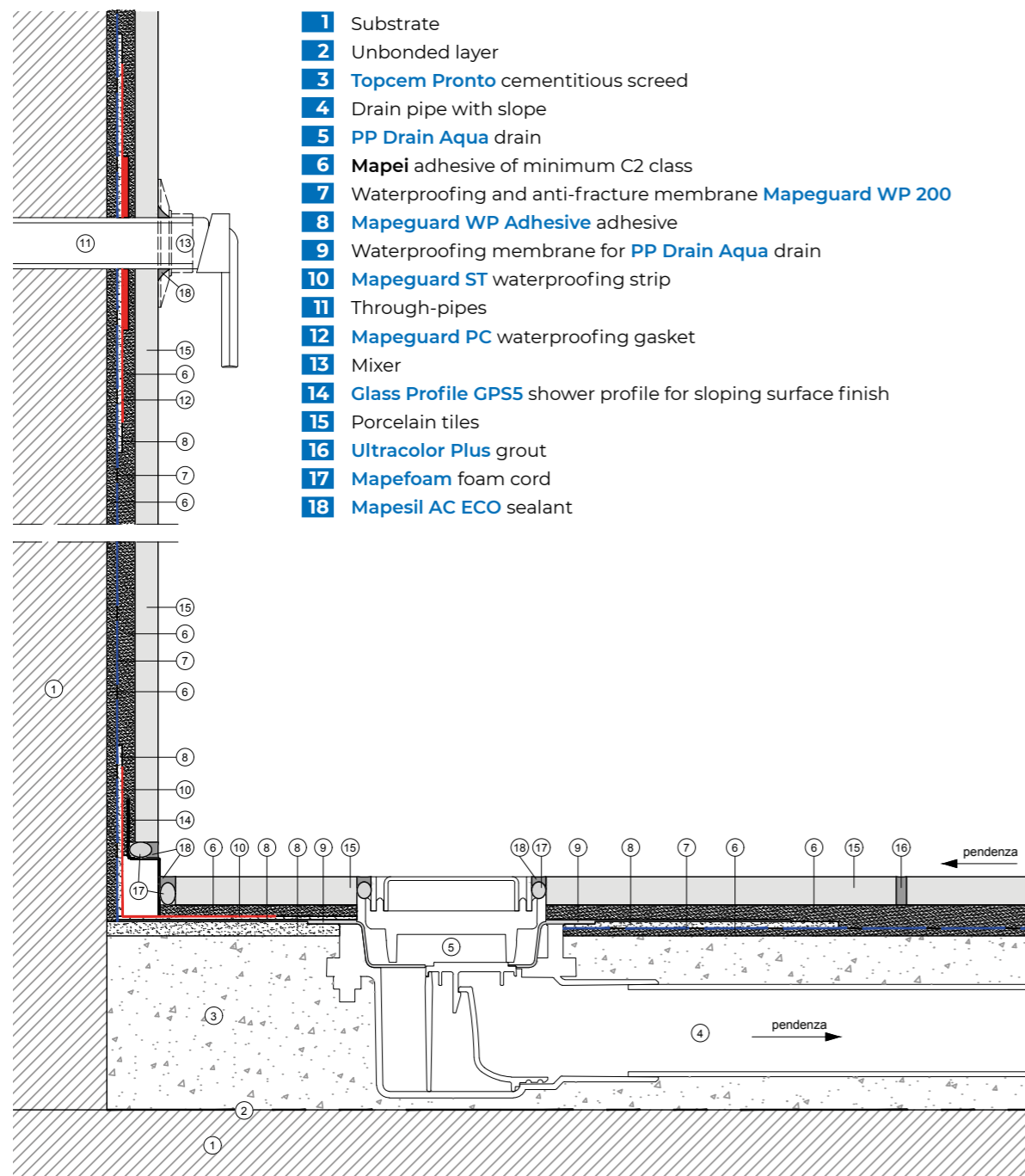

Mapeguard WP System

Waterproofing wall-to-floor connection shower.

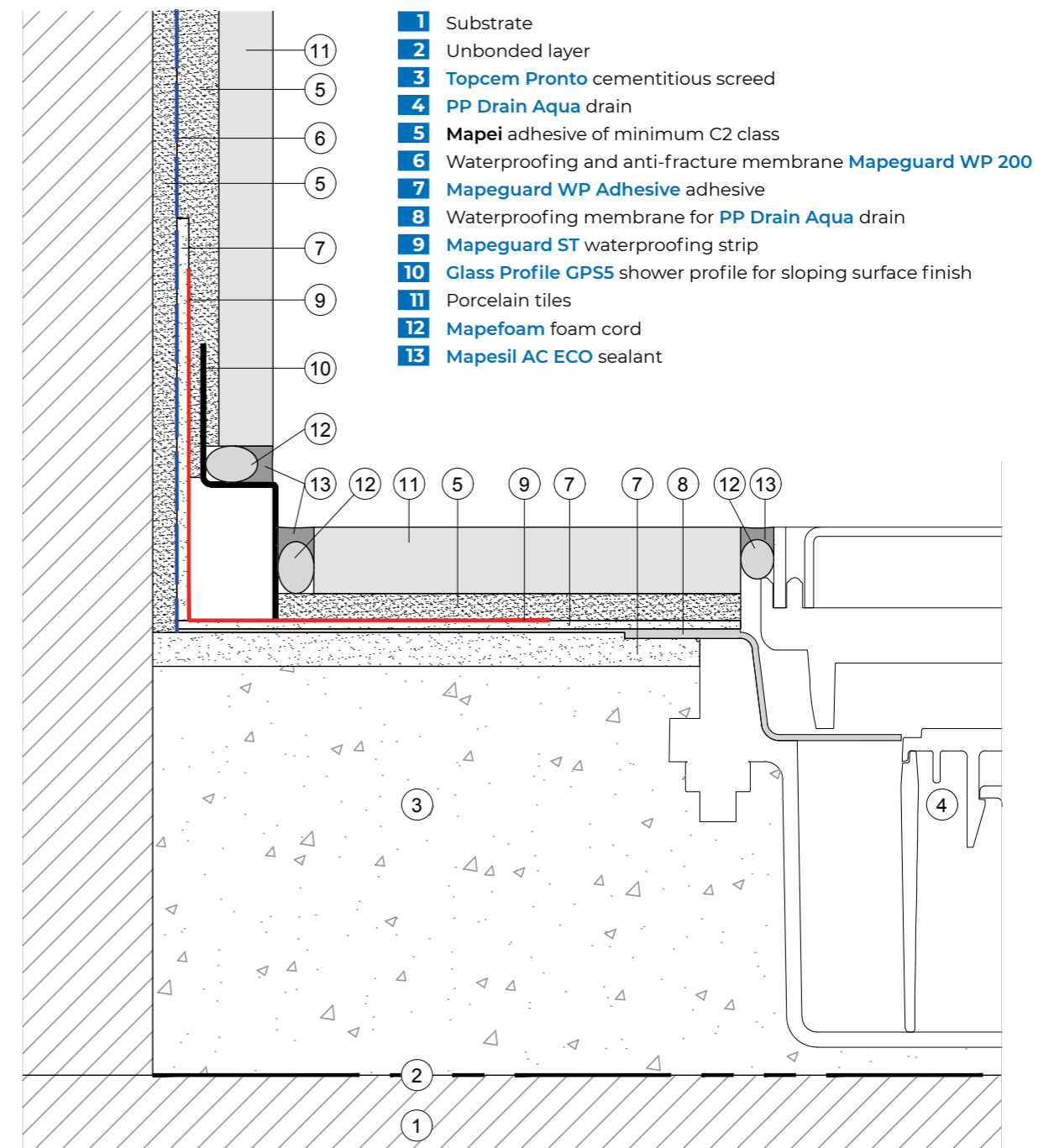

Technical details

Mapeguard WP System

Waterproofing the shower floor with **PP Drain Aqua** drain.

- 1** Substrate
- 2** Unbonded layer
- 3** **Topcem Pronto** cementitious screed
- 4** Drain pipe with slope
- 5** **PP Drain Aqua** drain
- 6** **Mapei** adhesive of minimum C2 class
- 7** Waterproofing and anti-fracture membrane **Mapeguard WP 200**
- 8** **Mapeguard WP Adhesive** adhesive
- 9** Waterproofing membrane for **PP Drain Aqua** drain
- 10** **Mapeguard ST** waterproofing strip
- 11** Porcelain tiles
- 12** **Mapefoam** foam cord
- 13** **Mapesil AC ECO** sealant

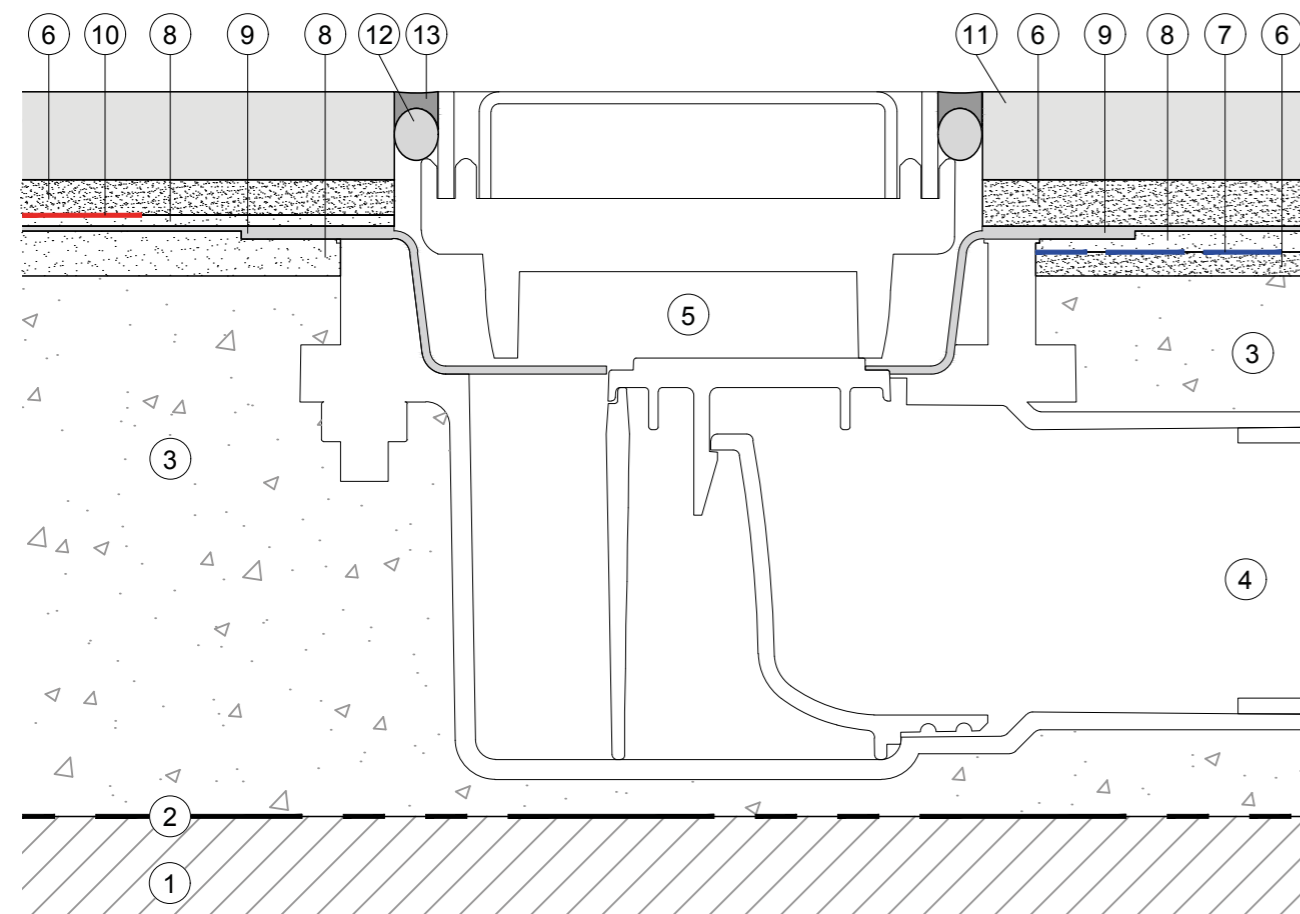

Mapeguard WP System

Waterproofing the shower floor with drainage detail.

- 1** Substrate
- 2** Unbonded layer
- 3** **Topcem Pronto** cementitious screed
- 4** Drain pipe with slope
- 5** Metal or pvc drain
- 6** **Mapei** adhesive of minimum C2 class
- 7** Waterproofing and anti-fracture membrane **Mapeguard WP 200**
- 8** **Mapeguard SA** self-adhesive tape
- 9** **Mapeguard WP Adhesive** adhesive
- 10** **Mapeguard ST** waterproofing strip
- 11** Porcelain tiles
- 12** **Mapefoam** foam cord
- 13** **Mapesil AC ECO** sealant

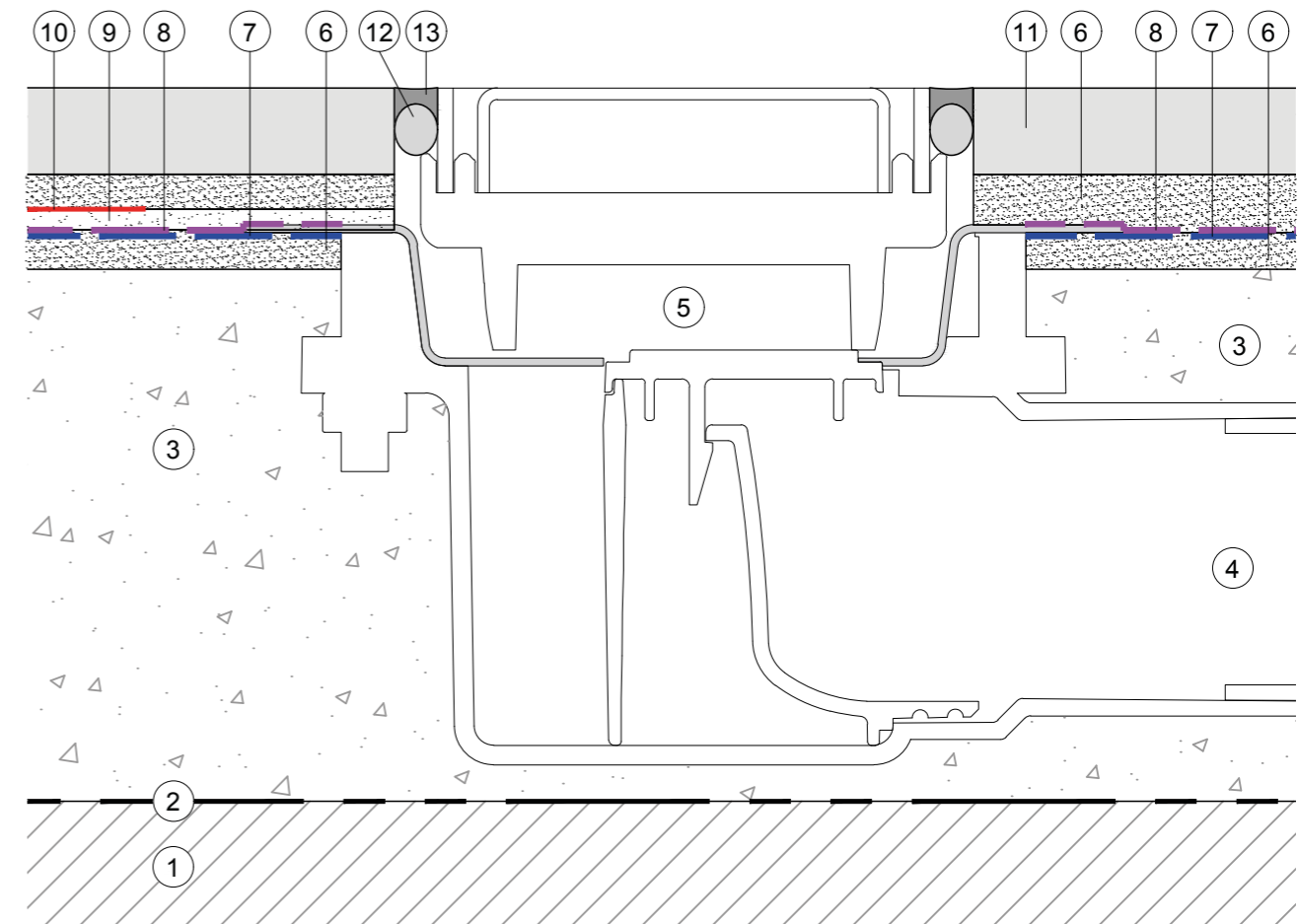

Technical details

Mapeguard WP System

Waterproofing shower through-pipes.

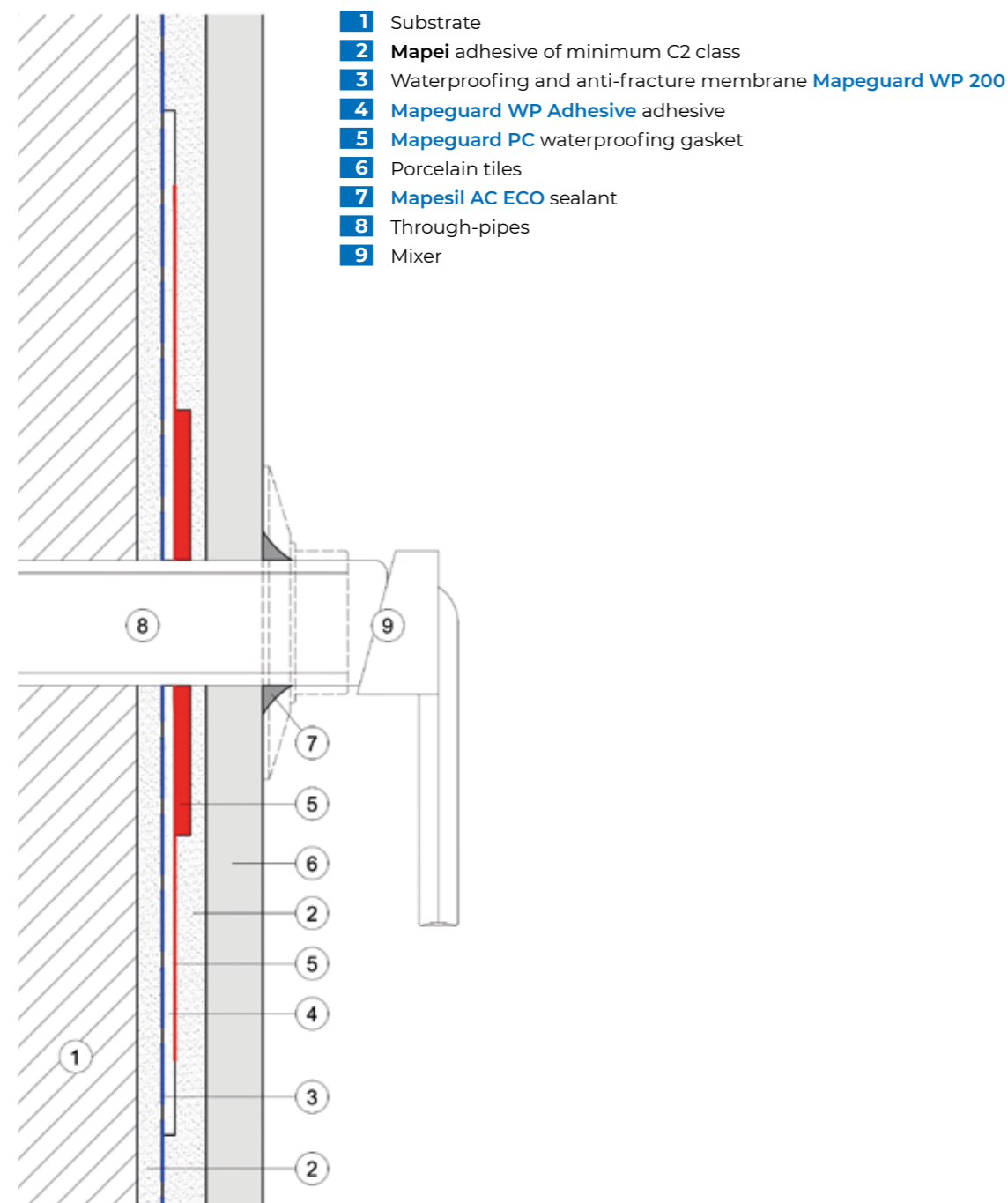

Mapeguard WP System

Waterproofing of floors at different heights between inside and outside shower surface with insertion of glass wall.

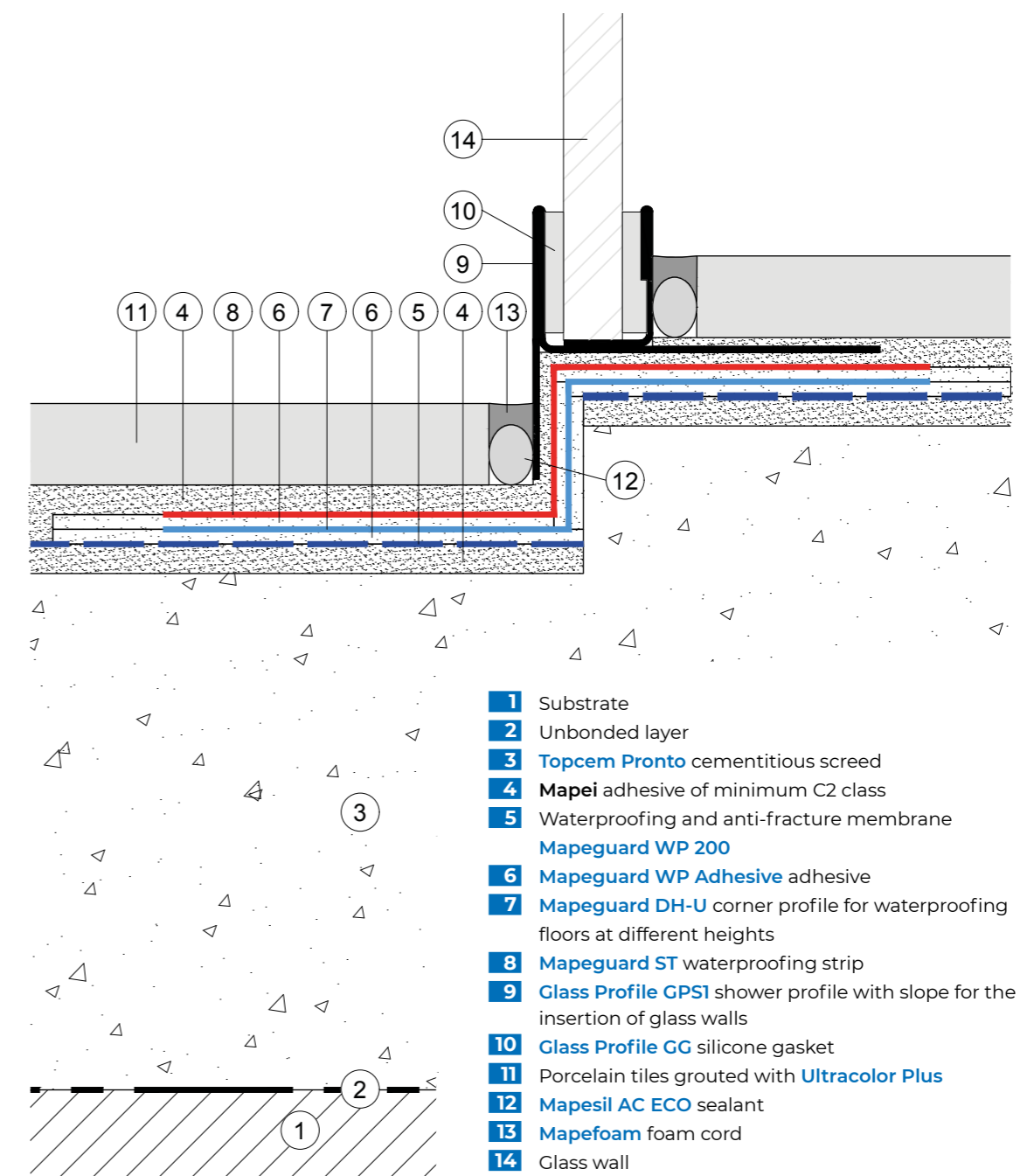

The **Mapei** systems complete
each other with



For further information on **Mapei** products, always consult the technical data sheets of the products available at www.mapei.com. For more detailed information than that indicated in this document, please contact **Mapei Technical Services**.

EVERYTHING'S OK,
WITH MAPEI



HEAD OFFICE
MAPEI SpA
Via Cafiero, 22
20158 Milan
Tel. +39-02-37673.1
mapei.com
mapei@mapei.it