

# ***Structural strengthening manual***

**Cutting-edge systems and solutions for the repair and static / seismic upgrading of buildings using fibre reinforced composites**



Cover picture:

*The Church of San Bernardino in L'Aquila - Italy*

# Structural strengthening manual

<b>Cutting-edge systems and solutions for the repair and static / seismic upgrading of buildings using fibre reinforced composite materials</b>	<b>page</b>	<b>5</b>
<b>Structural Strengthening Line: a system perfected and consolidated through 17 years of experience</b>	<b>page</b>	<b>6</b>
<b>1 Mapei FRP System</b>	<b>page</b>	<b>8</b>
1.1 What is the Mapei FRP System?	page	8
1.2 FRP materials	page	8
1.3 FRP in the building industry	page	9
1.4 Types of FRP used in building work	page	10
1.5 Types of intervention using FRP	page	11
1.6 FRP System Line: Products	page	12
<b>2 Mapei FRG System</b>	<b>page</b>	<b>17</b>
2.1 What is the Mapei FRG System?	page	17
2.2 FRG materials	page	17
2.3 Advantages of FRG	page	18
2.4 Types of intervention using FRG	page	20
2.5 FRG System Line: Products	page	20
<b>3 Reference norms and standards</b>	<b>page</b>	<b>22</b>

<b>4</b>	<b>Flexural strengthening</b>	<b>page 23</b>
4.1	Flexural strengthening of concrete beams	page 23
4.2	Flexural strengthening and floor joists	page 30
4.3	Flexural strengthening of wooden beams	page 33
<b>5</b>	<b>Shear strengthening</b>	<b>page 37</b>
5.1	Shear strengthening of beams	page 37
5.2	Shear/tensile strengthening of masonry structures	page 42
5.2.1	Laboratory testing: “Diagonal compression tests on tuff masonry panels strengthened with CMF: PLANITOP HDM + MAPEGRID G220”	page 44
5.2.2	Laboratory testing: “Diagonal compression tests on tuff masonry panels strengthened with CMF: PLANITOP HDM RESTAURO + MAPEGRID G 220 and PLANITOP HDM RESTAURO + MAPEGRID B250”	page 47
<b>6</b>	<b>Confinement of columns</b>	<b>page 50</b>
6.1	Confinement of reinforced concrete columns	page 50
<b>7</b>	<b>Seismic upgrading</b>	<b>page 54</b>
7.1	Properties of strengthening systems for the seismic upgrading of structures	page 55
7.2	Localised strengthening of column beam junction	page 55
7.3	Strengthening of masonry arches and vaults	page 61

7.4	Tie area strips	page 65
7.5	Anchoring ropes	page 67
7.6	Seismic upgrading of non load-bearing structures	page 70
7.6.1	Anti-overturning system for buffer walls	page 71
7.6.2	Seismic protection system for non-structural partition walls	page 73
7.6.2.1	Laboratory tests carried out on a vibrating test table	page 74
7.7	Installations on damaged or deficient vertical structural members in industrial buildings	page 77
7.7.1	Confinement and strengthening at the base of pillars by forming a sleeve in HPFRC	page 79
7.7.2	Combined bending and axial load around the strengthening around the base of pillars using fibre reinforced composites with anchoring ropes	page 80
<b>8</b>	<b>Mapei Technical Services</b>	<b>page 84</b>
8.1	“Mapei FRP Formula” calculation software	page 84
8.2	On-site technical support	page 86
8.3	Design support	page 88



## **Cutting-edge systems and solutions for the repair and static / seismic upgrading of buildings using fibre reinforced composite materials**

There is an increasingly widespread demand for structural safety in the civil building sector and, for obvious social and economical reasons, particularly in areas where there is a risk of seismic activity. This is why an increasing amount of resources are used for repairing (retrofitting) and strengthening (upgrading) existing reinforced concrete and masonry structures.

Composites are becoming increasingly popular in this sector thanks to the development of new fibres and matrixes and for the diffusion of applications based on the use of innovative technologies as an alternative to traditional systems. Composites have also proven to be a highly efficient solution to safeguard the integrity of structures in exceptional conditions, such as interventions carried out in emergency situations to make structures damaged by seismic activity safe, or to temporarily preserve them. Another area where there is considerable interest is for the structural strengthening of buildings of particular artistic or historical value, where requirements such as “reversibility”, “transparency” and “selectivity” are distinguishing features.

With reference to the aforementioned areas of the civil building sector and to structural features and members in reinforced concrete and masonry, this manual illustrates the state of the art of the most typical, significant application procedures using composites and highlights their purpose and strategy, as well as their advantages compared with traditional systems.

# Structural Strengthening Line: a system perfected and consolidated through 17 years of experience



Assisi earthquake



Salò earthquake

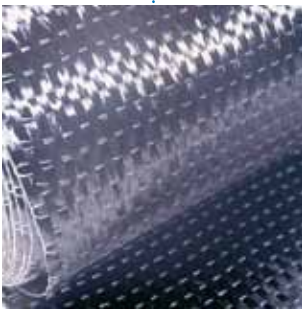

MAPEWRAP  
C UNI-AX



MAPEI  
FRP SYSTEM

1997

2002

2004

2005 2006

San Giuliano di Puglia  
earthquake



MAPEWRAP  
C QUADRI-AX



MAPEWRAP  
S FIOCCO



MAPEI  
FRG SYSTEM





*L'Aquila earthquake*



*Emilia-Romagna  
earthquake*

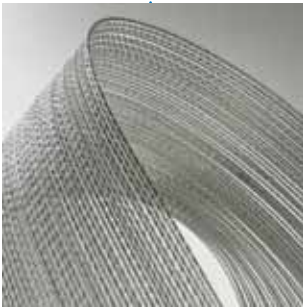

*MAPEWRAP  
S FABRIC*



*MAPEWRAP  
EQ SYSTEM*

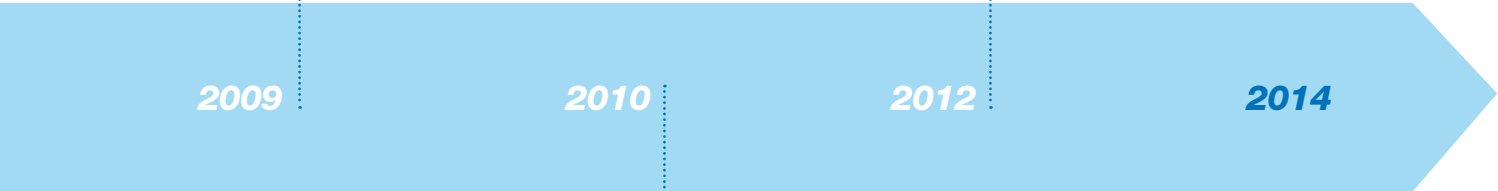

**2009**

**2010**

**2012**

**2014**



*MAPEGRID B 250*



*MAPEWRAP B UNI-AX*

# 1. *Mapei FRP System*

## 1.1. *What is the Mapei FRP System?*

**The Mapei FRP System** is a complete range of composites made from very high strength and extremely high mechanical strength fibres and polymeric resins specially formulated for the strengthening and static and seismic upgrading of structures made from normal, pre-stressed and reinforced concrete, steel, masonry or wood.

## 1.2. *FRP materials*

The term **FRP** stands for **Fibre Reinforced Polymer**. FRP's are part of the more vast family of "structural composites" and are made from strengthening fibres set in a polymer matrix. In fibre reinforced composites, the fibres act as load-bearing members to offer strength and stiffness, while the matrix, apart from protecting the fibres, acts as an element that transfers the stresses between the fibres and matrix and the structural member to which the composite has been applied. The fibres may be disposed in any direction, depending on design specifications, in order to optimise the mechanical properties of the composite in the directions required. The particular characteristic of structural composites is that they provide better, or at least more "complete", mechanical properties than those that would otherwise be provided by the single components. In polymeric matrix composites the matrix is generally made from epoxy resins and, by mixing them with an appropriate reactant, they polymerise (cure) to form a solid, glassy material. Strengtheners are made from:

**Carbon fibres:** carbon fibres are either high strength with a high modulus of elasticity or high strength with a very high modulus of elasticity (HM).

**Glass fibres:** glass fibres are either type E or type A.R. (alkali resistant).

**Basalt fibres:** their properties lie somewhere between those of carbon and glass fibres, with mechanical strength comparable with that of carbon fibres and a modulus of elasticity similar to that of glass fibres.

**Metallic fibres:** steel fibres with very high mechanical strength.

FRP's have already been used for many years in the naval, aeronautic and military sectors where they have been exploited for their unparalleled specific

strength (which means their level of tensile strength per unit of weight). Thanks to their increasingly widespread use and optimisation of the production processes adopted to manufacture them, in particular carbon fibres, costs are now much lower and has led to FRP's being introduced also into the construction sector.

### 1.3. FRP in the building industry

The use of FRP's in the construction industry applies mainly to the renovation of weak or damaged structures and the static and seismic upgrading of structures. In this context, repair work based on the use of high performance composites is more cost effective than traditional methods if the overall economic valuation takes into consideration the time required and the tools and equipment employed for the intervention, the costs involved in putting a structure out of service and the estimated working life of the structure itself once the intervention has been completed.

In fact, thanks to their low weight, FRP's do not require special equipment or lifting gear to put them in place, only a small workforce is required to place the materials in a very short space of time and, in many cases, it is not even necessary to interrupt the normal activities of the structure itself.

Figure 1.1 - The Church of San Bernardino in L'Aquila (Italy)



1.1



Figure 1.2 - The Church of San Marco in L'Aquila (Italy)

#### 1.4. Types of FRP used in building work

Fibre reinforced polymer matrix materials are heterogeneous, anisotropic, composite materials that have a linear elastic behaviour up to their failure point. Structural composites are used to strengthen structures in the form of the following types of fabric:

- **uniaxial**, where all the fibres run in a longitudinal direction along the length of the fabric and are held together in a non-structural, lightly woven pattern;
- **biaxial**, made up of an orthogonal weft-warp weave that is normally in a well balanced pattern (the same percentage of fibres in both directions);
- **quadriaxial**, in which the fibres run in various directions along the plane of the fabric.

The fabrics are supplied dry in the form of rolls and then impregnated either before laying (“wet system”) or after laying (“dry system”).

As well as fabrics, there are also rigid elements available that are pre-impregnated with resin using an industrial extrusion process where the element is pulled, called pultrusion. These elements are supplied in the form of **plates** and **bars**, and are bonded to the structure to be strengthened using epoxy resins with a thixotropic consistency.

The main parameter that defines the characteristics of FRP strengthening is not its tensile strength, which is always far greater than the workloads to which FRP strengthening is subjected, but its modulus of elasticity. The higher the modulus of elasticity of the fibres, the higher the amount of stiffness they supply.

### **1.5. Types of intervention using FRP**

There is a very wide range of applications where FRP may be employed:

- repairing and static and seismic upgrading of unstable or weak structures where the shear strength needs to be supplemented;
- confinement of compressed or compressed/flexed members (pillars, bridge piles, chimneys) to improve their load-bearing properties or their ductility where longitudinal reinforcement also needs to be supplemented.
- strengthening flexed members by creating an external sleeve to the areas subjected to tensile loads;
- repairing structures with localised impact damage, such as bridge beams hit by trucks carrying tall or wide loads;
- seismic upgrading and restoration of domed structures without increasing their seismic mass and without the risk of liquids percolating towards the internal surface;
- creating sleeves around beam-pillar hinge zones for seismic upgrading;
- strengthening load-bearing members in buildings whose structural system has been modified due to new architectural requirements or change in use;
- repairing structures damaged by fire;
- seismic upgrading of reinforced concrete industrial buildings.



Figure 1.3 - Modus Perfumery in Viareggio (Italy)

Figure 1.4 - The Church of Camposanto (Italy), damaged by the Emilia earthquake



### 1.6. FRP System Line: Products

The **Mapei FRP System** line for structural strengthening work consists of a wide range of uniaxial, biaxial and quadriaxial carbon fibre fabrics (MAPEWRAP C) available in various weights, sizes and moduli of elasticity; uniaxial and quadriaxial glass fibre fabrics (MAPEWRAP G) available in various weights; uniaxial, high-strength basalt fibre fabric (MAPEWRAP B) available in various weights; steel fibre fabrics (MAPEWRAP S FABRIC); a wide range of cords in carbon fibre (MAPEWRAP C FIOCCO), glass fibre (MAPEWRAP G FIOCCO) and steel fibre (MAPEWRAP S FIOCCO); pultruded carbon fibre plates (CARBOPLATE), available in various sizes and moduli of elasticity; pultruded bars in carbon fibre (MAPEROD C) and glass fibre (MAPEROD G); pultruded carbon fibre tubes (CARBOTUBE) and a vast range of epoxy adhesives for impregnating and bonding (MAPEWRAP PRIMER 1, MAPEWRAP 11/12, MAPEWRAP 21 and MAPEWRAP 31).

## Product data and performance characteristics

### CARBOPLATE pultruded carbon fibre plates

Type	CARBOPLATE E170	CARBOPLATE E200	CARBOPLATE E250
Modulus of elasticity (MPa)	170,000	200,000	250,000
Tensile strength (MPa)	≥ 3,100	3,300	2,500
Elongation at failure (%)	2	1.4	0.9
Width (mm)	50 100 150	50 100 150	50 100 150



CARBOPLATE

### MAPEWRAP C UNI-AX carbon fibre fabric

Weight (g/m <sup>2</sup> )	300	600
Modulus of elasticity (MPa)	256,000	256,000
Tensile strength (MPa)	5,340	5,340
Elongation at failure (%)	2.1	2.1
Width (cm)	10 20 40	10 20 40



MAPEWRAP C UNI-AX

### MAPEWRAP C UNI-AX HM carbon fibre fabric

Weight (g/m <sup>2</sup> )	300	600
Modulus of elasticity (MPa)	390,000	390,000
Tensile strength (MPa)	4,410	4,410
Elongation at failure (%)	1.1	1.1
Width (cm)	10 20 40	10 20 40



MAPEWRAP C UNI-AX HM

### MAPEWRAP C BI-AX carbon fibre fabric

Weight (g/m <sup>2</sup> )	230	360
Modulus of elasticity (MPa)	230,000	230,000
Tensile strength (MPa)	> 4,800	> 4,800
Elongation at failure (%)	2.1	2.1
Width (cm)	20 40	20 40



MAPEWRAP C BI-AX

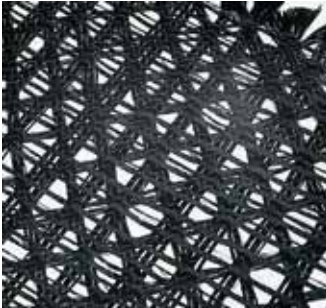

MAPEWRAP C QUADRI-AX

**MAPEWRAP C QUADRI-AX carbon fibre fabric**

Weight (g/m <sup>2</sup> )	380	760
Modulus of elasticity (MPa)	230,000	230,000
Tensile strength (MPa)	> 4,800	> 4,800
Elongation at failure (%)	2.1	2.1
Width (cm)	30 48.5	30 48.5



MAPEWRAP G UNI-AX

**MAPEWRAP G UNI-AX glass fibre fabric**

Weight (g/m <sup>2</sup> )	300	900
Modulus of elasticity (MPa)	80,700	80,700
Tensile strength (MPa)	2,560	2,560
Elongation at failure (%)	3-4	3-4
Width (cm)	30 60	30 60



MAPEWRAP G QUADRI-AX

**MAPEWRAP G QUADRI-AX glass fibre fabric**

Weight (g/m <sup>2</sup> )	1,140
Modulus of elasticity (MPa)	73,000
Tensile strength (MPa)	> 2,600
Elongation at failure (%)	3.5-4
Width (cm)	30 48.5



MAPEWRAP B UNI-AX

**MAPEWRAP B UNI-AX basalt fibre fabric**

Weight (g/m <sup>2</sup> )	400	600
Modulus of elasticity (MPa)	89,000	89,000
Tensile strength (MPa)	4,840	4,840
Elongation at failure (%)	≥ 2	≥ 2
Width (cm)	40	40



## MAPEWRAP S FABRIC steel fibre fabric

Weight (g/m <sup>2</sup> )	2,100
Modulus of elasticity (MPa)	210,000
Tensile strength (MPa)	> 2,845
Elongation at failure (%)	> 2.6
Width (cm)	30

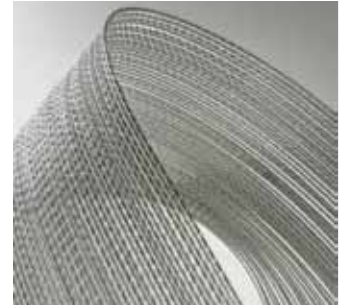

MAPEWRAP S FABRIC



1.5

Figure 1.5 - La Gardenia warehouse (Italy)

MAPEWRAP PRIMER 1	Component A	Component B
Mixing ratio	3	1
Density of mix (g/cm <sup>3</sup> )	1.1	
Brookfield viscosity of mix (mPa·s)	300	
Workability time at +23°C	90 mins.	
Setting time at +23°C	3-4 h	
Complete hardening time	7 days	
Adhesion to concrete (N/mm <sup>2</sup> )	> 3 (after 7 days at +23°C - failure of concrete)	
Consumption	250-300 g/m <sup>2</sup>	



MAPEWRAP PRIMER 1



MAPEWRAP 11/12

MAPEWRAP 11/12	Component A	Component B
Mixing ratio	3	1
Density of mix (kg/l)	1.70	
Brookfield viscosity of mix (mPa·s)	800	
Workability time at +23°C	35 mins. (MAPEWRAP 11) 50 mins. (MAPEWRAP 12)	
Setting time at +23°C	3-3 h 30 mins. (MAPEWRAP 11) 4-5 h (MAPEWRAP 12)	
Complete hardening time	7 days	
Adhesion to concrete (N/mm <sup>2</sup> )	> 3	
Tensile strength (ASTM D 638) (N/mm <sup>2</sup> )	30	
Tensile elongation (ASTM D 638) (%)	1	
Compressive strength (ASTM C 579) (N/mm <sup>2</sup> )	70	
Flexural strength (ISO 178) (N/mm <sup>2</sup> )	70	
Compressive modulus of elasticity (ASTM C 579) (N/mm <sup>2</sup> )	8,000	
Flexural modulus of elasticity (ISO 178) (N/mm <sup>2</sup> )	5,000	
Consumption	1.55 kg/m <sup>2</sup> (per mm of thickness)	



MAPEWRAP 21

MAPEWRAP 21	Component A	Component B
Mixing ratio	4	1
Density of mix (g/cm <sup>3</sup> )	1.1	
Brookfield viscosity of mix (mPa·s)	300	
Workability time at +23°C	40 mins.	
Setting time at +23°C	50 mins.	
Adhesion to concrete (N/mm <sup>2</sup> )	> 3	
Tensile strength (ASTM D 638) (N/mm <sup>2</sup> )	30	
Tensile elongation (ASTM D 638) (%)	1.2	
Compressive strength (ASTM C 579) (N/mm <sup>2</sup> )	65	
Flexural strength (ISO 178) (N/mm <sup>2</sup> )	55	
Flexural modulus of elasticity (ISO 178) (N/mm <sup>2</sup> )	2500	
Compressive modulus of elasticity (ASTM C 579) (N/mm <sup>2</sup> )	2,000	
Consumption	according to the type and width of the fabric	

MAPEWRAP 31	Component A	Component B
Mixing ratio	4	1
Density of mix (g/cm <sup>3</sup> )	1.1	
Brookfield viscosity of mix (mPa·s)	7000	
Workability time at +23°C	40 mins.	
Setting time at +23°C	50 mins.	
Adhesion to concrete (N/mm <sup>2</sup> )	> 3	
Tensile strength (ASTM D 638) (N/mm <sup>2</sup> )	40	
Tensile elongation (ASTM D 638) (%)	1.8	
Compressive strength (ASTM C 579) (N/mm <sup>2</sup> )	60	
Flexural strength (ISO 178) (N/mm <sup>2</sup> )	70	
Flexural modulus of elasticity (ISO 178) (N/mm <sup>2</sup> )	3000	
Compressive modulus of elasticity (ASTM C 579) (N/mm <sup>2</sup> )	1,400	
Consumption	according to the type (uniaxial, biaxial or quadriaxial) and width of the fabric	

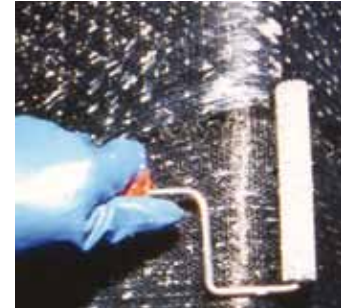

MAPEWRAP 31

## 2. Mapei FRG System

### 2.1. What is the Mapei FRG System?

The **Mapei FRG System** is a complete range of composites which, unlike traditional FRP, uses an inorganic, pozzolanic mortar rather than a polymer matrix to guarantee excellent chemical-physical and elasto-mechanical compatibility with masonry substrates (stone, bricks and tuff). They are used for the repair or static and seismic upgrading of all types of concrete and masonry structures.

### 2.2. FRG materials

The term **FRG** stands for “**Fibre Reinforced Grout**”. FRG’s are made from strengthening fibres set in an inorganic matrix. These types of material offer a series of advantages, including when used on buildings of historical or artistic interest, such as:

- **high mechanical strength;**
- **low architectonic impact;**
- **high durability;**
- **ease of application;**
- **reversibility.**

The application of this type of material overcomes the problem of the inherently low tensile and shear strength of masonry and increases the overall ductility of structures. This innovative, technologically advanced consolidating system is used in this sector through a series of inorganic matrix composites consisting of glass or basalt fibre mesh with a square weave applied to structures using highly ductile, two-component, ready-mixed cementitious mortar. For listed buildings strengthening materials must have specific characteristics, so the choice of strengthening materials and techniques that may be employed is limited. We have to consider, for example, how strengthening work using cementitious-based products would be both historically and chemically incompatible with the lime-based materials originally used. This is why recent technology implemented by Mapei employs composite materials consisting of the combination of a structure of high strength fibres with a matrix of lime and Eco-pozzolan based mortar.

### **2.3. Advantages of FRG**

There are numerous advantages deriving from the use of products from the **Mapei FRG System** compared with traditional repair techniques, and the most significant are as follows:

- simple, quick application: thanks to their low weight, they do not require special equipment or lifting gear to install them, only a small workforce is required to install the materials in a very short space of time and, in many cases, it is not even necessary to interrupt the normal activities of the structure itself;
- highly durable;
- unlike repair work by cladding with steel plates (the beton-plaqué technique), there is no problem of corrosion of the strengthening materials applied;

- no increase of the mass involved: installation using **Mapei FRG System** does not increase the overall mass of the structural members that have been strengthened. This is extremely important, particularly in the field of seismic upgrading, where the stresses are proportional to the mass involved;
- installations are completely reversible: installations using the **Mapei FRG System** are completely reversible, in that the strengthening materials and layers of adhesive may be completely removed and the structure returned to the same condition as before the installation. This characteristic is particularly important when carrying out work to make buildings temporarily safe, especially those of historical interest.

*Figure 2.1 - The Church  
of the Holy Spirits  
in L'Aquila (Italy)*



2.1

## 2.4. Types of intervention using FRG

Inorganic matrix composites may be used for the following:

- structural strengthening of facing walls, applied on the internal and/or external face;
- strengthened reinforcement for both concrete and masonry members to distribute stresses induced by seismic activity more uniformly;
- strengthened reinforcement and attachment points to hold load-bearing walls together correctly and more solidly to structures with a reinforced concrete framework.

## 2.5. FRG System Line: Products

The **Mapei FRG System** line for strengthening work consists of pre-primed, alkali-resistant (A.R.) glass fibre mesh (MAPEGRID G 120 and MAPEGRID G 220) available in various weights and mesh sizes; pre-primed basalt fibre mesh (MAPEGRID B 250); two-component, high ductility, fibre reinforced, pozzolanic reaction cementitious mortar (PLANITOP HDM / PLANITOP HDM MAXI); two-component, high ductility, ready-mixed hydraulic lime (NHL) and Eco-pozzolan-based mortar (PLANITOP HDM RESTAURO).

### Product data and performance characteristics

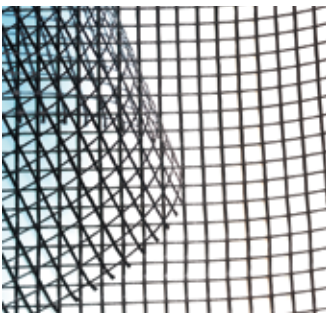

MAPEGRID G 120

MAPEGRID G 120	
Type of fibre	A.R. glass fibre
Weight (g/m <sup>2</sup> )	125
Mesh size (mm)	12.7 x 12.7
Tensile strength (kN/m)	30
Elongation at failure (%)	< 3
Total cross-sectional area (mm <sup>2</sup> /ml)	91.67

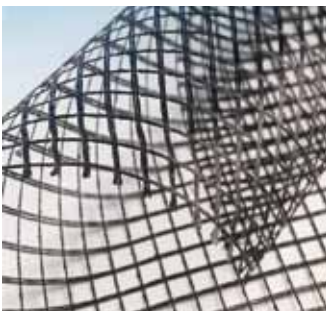

MAPEGRID G 220

MAPEGRID G 220	
Type of fibre	A.R. glass fibre
Weight (g/m <sup>2</sup> )	225
Mesh size (mm)	25 x 25
Tensile strength (kN/m)	45
Elongation at failure (%)	< 3
Total cross-sectional area (mm <sup>2</sup> /ml)	165

MAPEGRID B250	
Type of fibre	basalt fibre
Weight (g/m <sup>2</sup> )	250
Mesh size (mm)	6 x 6
Tensile strength (kN/m)	3,000
Elongation at failure (%)	≤ 2
Total cross-sectional area (mm <sup>2</sup> /ml)	41

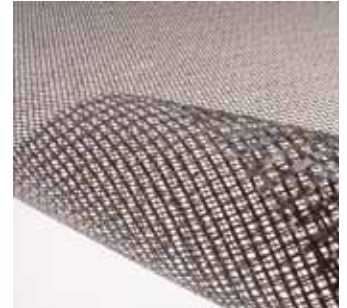

MAPEGRID B 250

PLANITOP HDM RESTAURO	
Density of mix (kg/m <sup>3</sup> )	1,900
Thickness applied	from 3 to 10 mm per layer
Application temperature range	from +5°C to +35°C
Pot life of mix	approx. 1 h (at +20°C)
Compressive strength after 28 days (N/mm <sup>2</sup> )	≥ 15
Initial shear strength (N/mm <sup>2</sup> )	≥ 0.15
Compressive modulus of elasticity (MPa)	8,000
Adhesion to masonry after 28 days (N/mm <sup>2</sup> )	> 0.80



PLANITOP HDM RESTAURO

Category:

- Type G masonry mortar, category M15;
- Type GP rendering mortar, category CS IV.

PLANITOP HDM	
Density of mix (kg/m <sup>3</sup> )	1,800
Thickness applied	up to 6 mm per layer
Setting time (start to finish)	4-9 h
Pot life of mix	approx. 1 h (at +23°C)
Compressive strength after 28 days (N/mm <sup>2</sup> )	≥ 30
Flexural strength (N/mm <sup>2</sup> )	≥ 9
Compressive modulus of elasticity (MPa)	11,000
Adhesion to masonry after 28 days (N/mm <sup>2</sup> )	≥ 2
Consumption (kg/m <sup>2</sup> )	1.8 (per mm of thickness)



PLANITOP HDM



PLANITOP HDM MAXI

PLANITOP HDM MAXI	
Density of mix (kg/m <sup>3</sup> )	1,850
Thickness applied	from 6 to 25 mm per layer
Pot life of mix	approx. 1 h (at +20°C)
Compressive strength after 28 days (N/mm <sup>2</sup> )	> 25
Flexural strength (N/mm <sup>2</sup> )	8
Compressive modulus of elasticity (MPa)	10,000
Adhesion to masonry after 28 days (N/mm <sup>2</sup> )	> 2
Consumption (kg/m <sup>2</sup> )	1.85 (per mm of thickness)

### 3. Reference norms and standards

Design work incorporating the use of FRP's is not covered by specific standards according to **NTC 08** (the Italian Construction Standards Guide), although **Chapter 8.6** of the guide does imply the use of “*non-conventional materials with the premise that they comply with the standards and currently valid documents listed in Chapter 12*” for interventions on existing constructions.

**NTC 08 chapter 12:** “*With regard to those conditions not expressly specified in this guide, the indications contained within the following documents are to be considered valid in satisfying the principles on which this guide is based:*

- *Structural Eurocodes issued by CEN, the European Committee for Standardisation, with the clarifications and indications in the relative National Annexes or, in their absence, in the applicable international EN;*
- *Harmonised UNI EN Standards published in the Official Journal of the European Union;*
- *Testing, materials and product standards issued by UNI (the Italian Organisation for Standardisation).*

*Where specific indications do not exist, the following documents may be considered valid and used to integrate current norms and standards as long as they are not contradictory to such norms and standards:*

- *Instructions issued by the Board of Public Works;*
- *Guidelines issued by the Central Technical Services Department of the Board of Public Works;*
- *Guidelines for the evaluation and reduction of risk to the cultural heritage due*



to seismic activity and successive modifications and addendums issued by the Ministry of Cultural Heritage and Affairs, as granted by the Board of Public Works;

- *Technical instructions and documents issued by the CNR (the Italian National Research Centre)."*

The current reference norms actually applied in Italy for the design of strengthening installations with composites are contained in the document approved by the **CNR DT 200/2004: "Instructions for the Design, Execution and Control of Static Consolidation Installations using Fibre Reinforced Composites"** and **"Guidelines for the Design, Execution and Testing of Structural Strengthening Interventions on Reinforced Concrete, Pre-stressed Reinforced Concrete and Masonry using FRP"**, a document approved on the 24<sup>th</sup> of July 2009 by the General Assembly of the Board of Public Works.

The instructions contained in CNR-DT 200/2004 and the Guidelines approved on the 24<sup>th</sup> of July 2009, written by combining the knowledge and experience of manufacturers, users (designers and construction companies) and experts from universities and professional bodies, meet the country's need to understand and standardise this topic, and provide an organic reference standard for the design of reinforced concrete and masonry members and structures strengthened with FRP, with an approach to overall safety in line with Eurocode standards.

## 4. Flexural strengthening

Flexural strengthening is required for structural members subjected to a design bending moment higher than their corresponding nominal flexural capacity. Flexural strengthening with composites may be carried out by applying one or more layers of fabric to the strained area of the member to be strengthened (ref. CNR DT 200/2004 par. 4.2 and ReLuis Guidelines par. 3.3.1.1).

Flexural design at ULS of FRP strengthened members that both flexural capacity  $M_{rd}$ , and factored ultimate moment,  $M_{sd}$ , satisfy the following equation:

$$M_{sd} \leq M_{rd}$$

### 4.1. Flexural strengthening of concrete beams

This type of strengthening may be achieved by applying one or more plates of CARBOPLATE or one or more layers of uniaxial fabric, such as MAPEWRAP C UNI-AX, MAPEWRAP C UNI-AX HM, MAPEWRAP G UNI-AX, MAPEWRAP B UNI-AX or MAPEWRAP S FABRIC, to the strained areas of the beam.

## MAPEI FRP FORMULA - DESIGN OF FLEXURAL STRENGTHENING FOR A RECTANGULAR BEAM

The objective of the installation is to increase the load-bearing capacity of the structural members to be strengthened so that the stresses within the beams are reduced to the limits specified.

### Characteristics of the materials used in the calculation

- Height:  $H = 45 \text{ cm};$
- Base:  $b = 30 \text{ cm};$
- Area of steel in tension zone:  $RL = n^{\circ}2 \text{ } \varnothing 24 \text{ mm} \approx 904 \text{ mm}^2$
- Area of steel in compression zone:  $RU = n^{\circ}2 \text{ } \varnothing 24 \text{ mm} \approx 904 \text{ mm}^2$
- FeB38k grade steel:  $f_{yk} \geq 375 \text{ N/mm}^2$
- Concrete - C16/20:  $R_{ck} 20 \text{ N/mm}^2$

Design bending moment acting on the section:

- $M_{sd} = 117.59 \text{ kN}\cdot\text{m}$

The input data must be entered in cyan cells		
USER INPUT		
Cross Section Properties		
Depth of member ( H )	450	mm
Width ( B )	300	mm
Area of steel in tension zone $A_s$	904	mm <sup>2</sup>
Area of steel in compression zone $A_s'$	904	mm <sup>2</sup>
Cover ( $d1=d2$ )	20	mm
Effective depth ( d )	430	mm
Area of FRP reinforcement $A_f$	280	mm <sup>2</sup>

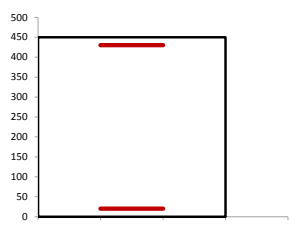





ADHESIVES · SEALANTS · CHEMICAL PRODUCTS FOR BUILDING

Technical Assistance - Structural Strengthening Line

Customer: Eng. Chris Keapple  
 Yard: Fmt 1, 72 Bedford Street, New York, NY  
 Ref. Struct.: 58-T316

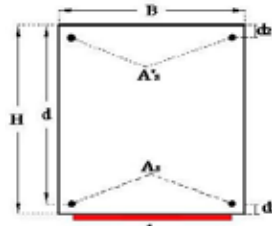
Materials properties		Design stress	Modulus of elasticity
		MPa	MPa
concrete class	C16/20	16.0	21000
steel	Feb38k	375	210000
$\epsilon_{s,el}$	0.00155	yielding strain of steel reinforcement	





**D.I.S.T.**  
 Department of Structural Engineering  
 University of Naples "Federico II"

## DESIGN/CALCULATION PROCEDURE

The analysis is carried out using the semi-probabilistic "Limit State Design" approach, taking into consideration the combined loads and then multiplying them by a safety factor.

## ACTIONS/STRESSES

FRP System	Strengthening systems	Fiber Type	Exposure Conditions
Carboplate E 170	Certified strengthening systems	Carbon	Aggressive environment

FRP Properties	
$\sigma$ ultimate tensile strength	3100 MPa
$\epsilon$ ultimate rupture strain, $\epsilon_{rk}$	0.018
Modulus of elasticity	170000 MPa
Thickness per ply	1.400 mm
Partial factor for resistance model ( $\gamma_{Fd}$ )	1.20
Reduction factor FRP ( $\gamma_f$ )	1.10
Environmental reduction factor ( $\eta_e$ )	0.85
$\sigma$ design, $f_{da}$	2196 MPa
Width of FRP reinforcing plies ( $b_f$ )	200 mm
Number of plies of FRP reinforcement	1

  

$k_{cr}$	3
$k_b$	1.000
$f_{tRd,2}$	407 MPa
$\epsilon_{Ed}$	0.002396
$f_{ck}$	16.60 MPa
$f_{ctm}$	1.95 MPa
$h_0/h$	0.667
$\epsilon$ design, $\epsilon_{FRP,ad}$	<b>0,00240</b>

Moment acting in the section at the time of the FRP installation ( $M_0$ )	<b>0</b>	kN m
--	----------	------

  

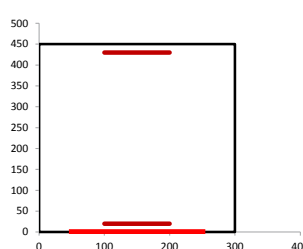



ADHESIVES · SEALANTS · CHEMICAL PRODUCTS FOR BUILDING

**Technical Assistance - Structural Strengthening Line**

Customer: Eng. Chris Keapple  
 Yard: Frnt 1. 72 Bedford Street, New York NY  
 Ref. Struct.: 58-T316



**D.I.S.T.**  
 Department of Structural Engineering  
 University of Naples "Federico II"

OUTPUT STRENGTHENED SECTION									
CALCULATED STRESS, STRAINS, NEUTRAL AXIS, DESIGN FLEXURAL STRENGTH OF THE SECTION									
$y_c$	failure region	$\psi$	$\lambda$	$\sigma'_s$	$\sigma_s$	$\sigma_r$	Solve	eq. Traslazione	$M_u$
[mm]		ad.	ad.	MPa	MPa	MPa		0,00	[kN m]
<b>120,02</b>	<b>1</b>	<b>0,80</b>	<b>0,416</b>	<b>152,51</b>	<b>326,09</b>	<b>407,31</b>			<b>161,79</b>
UNSTRENGTHENED SECTION								$\epsilon_c =$	<b>0,00087</b>
$y_c$	$\sigma'_s$	$\sigma_s$	$M_u$					$\epsilon'_s =$	<b>0,00073</b>
mm	MPa	MPa	kN m					$\epsilon_s =$	<b>0,00225</b>
<b>30</b>	<b>250,3</b>	<b>326,1</b>	<b>121,37</b>					$\epsilon_r =$	<b>0,00240</b>

The technique proposed, using products from the MAPEWRAP SYSTEM line, is applied "in parallel" to the existing structure. It acts in conjunction with the structure rather than replaces it, so that by working together the strength and load-bearing capacity of the beams are increased without modifying the distribution or stiffness of the masses.

TYPE OF STRENGTHENING  $\Rightarrow$  No. 2 butted plates of CARBOPLATE E 170/100

Flexural capacity of the strengthened member in the section after strengthening:

$M_{rd, ULS \text{ post-strengthening}} = 161.79 \text{ kN*m/beam} \Rightarrow$

$M_{sd} < M_{rd}$

## **APPLICATION TECHNIQUE FOR “CARBOPLATE” PLATES**

### Procedure

#### **1) Substrate preparation.**

Prepare all surfaces to be repaired by completely removing all weak concrete with a hand or power chisel or other suitable means, such as hydro-scarifying, to obtain a solid, sufficiently rough substrate with no detached portions. If the weak concrete has been removed with a hand or power chisel, clean all exposed reinforcing bars with a brush or by hydro-sandblasting to remove the rust and bring the reinforcing bars back to a bare metal finish. Hydro-sandblasting is not required if the surface has been prepared by hydro-scarifying, but you must wait quite a long time after this operation before treating the reinforcing bars due to on-site logistics constraints. After removing all the rust, treat the reinforcing bars by brush-applying two coats of MAPEFER or MAPEFER 1K one-component, anti-corrosion cementitious mortar. The specific function of both these products, made from cementitious binders, powdered polymers and corrosion inhibitors, is to prevent the formation of rust. Clean all surfaces to be repaired and saturate the substrate leaving a dry surface (s.s.d.) by hydro-cleaning. Reinststate the concrete using a product from the MAPEGROUT range.

**2) Apply an even coat of MAPEWRAP PRIMER 1 by brush or roller. If the substrate is particularly absorbent, apply a second coat of primer once the previous one has been completely absorbed.**

**3) Level off the surface where the CARBOPLATE is to be placed with a 1 to 2 mm thick layer of MAPEWRAP 11 or ADESILEX PG1 applied with a notched trowel while the MAPEWRAP PRIMER 1 is still wet. If epoxy adhesive with a longer workability time is required, MAPEWRAP 12 or ADESILEX PG2 may be used.**

**4) Cut the CARBOPLATE to the length required with a diamond-tipped grinding disk.**

**5) Remove the protective backing (peel-ply) from the CARBOPLATE. Skim the bonding surface of the CARBOPLATE with MAPEWRAP 11 or ADESILEX PG1. If epoxy adhesive with a longer workability time is required, MAPEWRAP 12 or ADESILEX PG2 may be used.**

**6) Remove all excess MAPEWRAP 11 or ADESILEX PG1 from the CARBOPLATE with a flat trowel.**

**7) Position the CARBOPLATE and apply an even pressure over the entire surface with a hard rubber roller.**

**8)** Eliminate all excess resin with a flat trowel, taking care not to move the carbon fibre plate. If more than one layer of CARBOPLATE is required, once the MAPEWRAP 11 or ADESILEX PG1 have hardened, carefully peel the second protective backing from the plate if it has not already been removed before placing it in position.

*(ref. "Design Guide" procedure G.1.2 and technical specifications G.1.2.1, G.1.2.2 and G.1.2.3)\*.*

### **APPLICATION TECHNIQUE FOR "MAPEWRAP" FABRICS USING THE "WET TECHNIQUE"**

#### Procedure

- 1)** Prepare the substrate *(as per procedure on page 26)*.
- 2)** Apply an even coat of MAPEWRAP PRIMER 1 by brush or with a roller. If the substrate is particularly absorbent, apply a second coat of primer once the previous one has been completely absorbed.
- 3)** Skim and even out the surface with a 1 to 2 mm thick layer of MAPEWRAP 11 applied with a notched trowel while the MAPEWRAP PRIMER 1 is still wet. If epoxy adhesive with a longer workability time is required, MAPEWRAP 12 may be used.
- 4)** Smooth over the surface of the adhesive with a flat trowel to eliminate even the smallest irregularities from the surface.
- 5)** Impregnate the pieces of fabric before laying them on the surface. This step may be carried out either manually or with suitable tools and equipment. For manual impregnation, cut the MAPEWRAP fabric to the size required with scissors and soak it for a few minutes in a plastic container (preferably rectangular) filled to around 1/3 with MAPEWRAP 21. Remove the fabric from the container, leave it to drip for a few seconds and then press it lightly without twisting to completely remove all the excess resin. Wear protective rubber gloves when carrying out this operation. As an alternative to manual impregnation, simple equipment with a bowl and a series of rollers may be used; this makes it easier and safer for the operator to saturate the fabric and remove the excess resin. This system is particularly recommended when a large number of installations on large surfaces need to be carried out and guarantees that the resin is distributed evenly in every part of the fabric.
- 6)** Position the MAPEWRAP fabric immediately after impregnation, making sure

\* "Design Guide" is available at our website [www.mapei.it](http://www.mapei.it) in the Specifications section

that it is spread on evenly without creases. Wear protective rubber gloves for this operation.

**7)** Go over the surface of the fabric with a MAPEWRAP ROLLER to make sure the adhesive and resin completely penetrates through the fibres. This operation is also necessary to eliminate air bubbles trapped in the fabric.

**8)** Wash the MAPEWRAP ROLLER with thinners immediately after use.

*(ref. "Design Guide" procedure **G.1.3** and technical specifications **G.1.3.1**, **G.1.3.2**, **G.1.3.3**, **G.1.3.4** and **G.1.3.5**)\*.*

## **APPLICATION TECHNIQUE FOR "MAPEWRAP" FABRICS USING THE "DRY TECHNIQUE"**

### Procedure

**1)** Prepare the substrate *(as per procedure on page 26)*.

**2)** Apply an even coat of MAPEWRAP PRIMER 1 by brush or with a roller. If the substrate is particularly absorbent, apply a second coat of primer once the previous one has been completely absorbed.

**3)** Skim and even out the surface with a 1 to 2 mm thick layer of MAPEWRAP 11 applied with a notched trowel while the MAPEWRAP PRIMER 1 is still wet. If epoxy adhesive with a longer workability time is required, MAPEWRAP 12 may be used.

**4)** Smooth over the surface of the adhesive with a flat trowel to eliminate even the smallest irregularities from the surface.

**5)** Apply an even coat of MAPEWRAP 31 with a brush or short-haired roller on the MAPEWRAP 11 or MAPEWRAP 12 while it is still wet.

**6)** Position the MAPEWRAP fabric immediately after applying the resin, making sure that it is spread on evenly without creases. Wear protective rubber gloves for this operation.

**7)** Go over the surface of the fabric with a MAPEWRAP ROLLER to make sure the adhesive and resin completely penetrate through the fibres. This operation is also necessary to eliminate air bubbles trapped in the fabric.

**8)** Apply another coat of MAPEWRAP 31 over the MAPEWRAP fabric. Go over the surface of the impregnated fabric with a MAPEWRAP ROLLER to eliminate air bubbles trapped in the fabric.

9) If any other product is to be applied on the surface of the fabric, we recommend dusting the MAPEWRAP 31 with sand while it is still wet.

(ref. "Design Guide" procedure **G.1.3** and technical specifications **G.1.3.1** to **G.1.3.5**)\*.

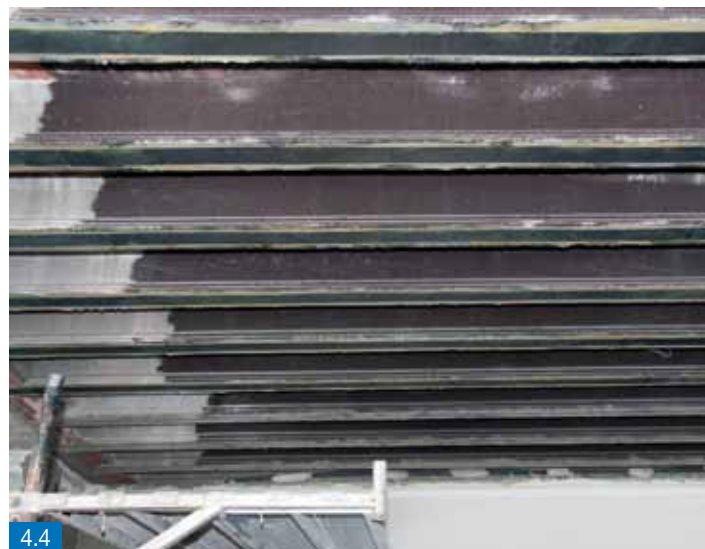

Figures 4.1, 4.2, 4.3 and 4.4 -  
Flexural strengthening of beams  
using CARBOPLATE plates

## 4.2. Flexural strengthening of floor joists

This type of strengthening may be achieved by applying one or more sheets of CARBOPLATE or one or more layers of uniaxial fabric, such as MAPEWRAP C UNI-AX, MAPEWRAP C UNI-AX HM, MAPEWRAP G UNI-AX, MAPEWRAP B UNI-AX or MAPEWRAP S FABRIC to the strained areas of the joist.

### MAPEI FRP FORMULA - DESIGN OF FLEXURAL STRENGTHENING FOR REINFORCED CONCRETE FLOOR JOISTS

The objective of the intervention is to increase the load-bearing capacity of floor joists due to a change in use that generates overloads.

Characteristics of the materials used in the calculation

- Joist section:  $H = 190 \text{ mm} + 50 \text{ mm};$
- Width of floor slab:  $W = 500 \text{ mm};$
- Width of joist:  $b = 120 \text{ mm};$
- Area of steel in tension zone:  $A_s = \text{No. } 3 \text{ } \varnothing 10 \text{ mm} \approx 314 \text{ mm}^2$
- Area of steel in compression zone: not available  $\approx 10 \text{ mm}^2$
- Steel: FeB38k ( $f_{yk} \geq 375 \text{ N/mm}^2$ )
- Concrete class: C 20/25

Design bending moment acting on the section:

- $M_{sd, ULS} = 20 \text{ kN}\cdot\text{m}$

**The analysis of the loads generates a bending moment in the section higher than the initial bending moment.**

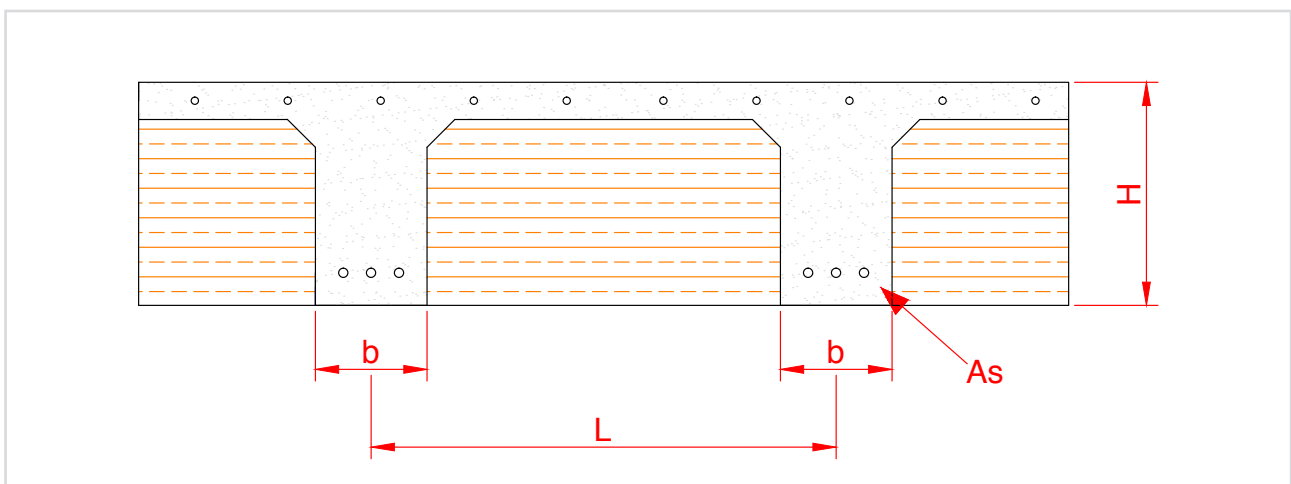



The input data must be entered in cyan cells		
USER INPUT		
Cross Section Properties		
Depth of member (H)	240	mm
Depth of slab (h)	50	mm
Width of slab (L)	500	mm
Width of web (b)	120	mm
Area of steel in tension zone A <sub>s</sub>	314	mm <sup>2</sup>
Area of steel in compression zone A' <sub>s</sub>	10	mm <sup>2</sup>
Cover (d <sub>1</sub> =d <sub>2</sub> )	20	mm
Effective depth (d)	220	mm
Depth of web (H-h)	190	mm
Area of FRP reinforcement A <sub>f</sub>	140	mm <sup>2</sup>

Materials properties			Design stress	Modulus of elasticity
			MPa	MPa
concrete class	C 20/25		11.76	30200
steel	Feb38k		326	210000
ε <sub>s,d</sub>	0.00155	yielding strain of steel reinforcement		

**MAPEI**  
ADHESIVES - SEALANTS - CHEMICAL PRODUCTS FOR BUILDING

Technical Assistance - Structural Strengthening Line  
 Customer: Eng. Chris Keapple  
 Yard: Fmt 1, 72 Bedford Street, New York, NY  
 Ref. Struct.: 58-T316

**D.I.S.T.**  
Department of Structural Engineering  
University of Naples "Federico II"

## DESIGN/CALCULATION PROCEDURE

The analysis is carried out using the semi-probabilistic "Limit State Design" approach, taking into consideration the combined loads and then multiplying them by a safety factor.

## ACTIONS/STRESSES

FRP System	Strengthening systems	Fiber Type	Exposure Conditions
Carboplate E 170	Certified strengthening systems	Carbon	Exterior exposure

FRP Properties	
σ ultimate tensile strength	3100 MPa
ε ultimate rupture strain, ε <sub>u</sub>	0.018
Modulus of elasticity	170000 MPa
Thickness per ply	1.400 mm
Partial factor for resistance model (γ <sub>f,d</sub> )	1.20
Reduction factor FRP (γ <sub>f</sub> )	1.10
Environmental reduction factor (η <sub>e</sub> )	0.85
σ design, f <sub>td</sub>	2196 MPa
Width of FRP reinforcing plies (b <sub>f</sub> )	100 mm
Number of plies of FRP reinforcement	1

k <sub>cr</sub>	3
k <sub>cy</sub>	1.000
f <sub>ctd2</sub>	447 MPa
ε <sub>f,d,d</sub>	0.002629
f <sub>td</sub>	20.75 MPa
f <sub>tdm</sub>	2.27 MPa
b <sub>f</sub> /b	0.833
ε design, ε <sub>FRP,d,d</sub>	0.00263

Moment acting in the section at the time of the FRP installation (M <sub>0</sub> )	0	kN m
--	---	------

**MAPEI**  
ADHESIVES - SEALANTS - CHEMICAL PRODUCTS FOR BUILDING

Technical Assistance - Structural Strengthening Line  
 Customer: Eng. Chris Keapple  
 Yard: Fmt 1, 72 Bedford Street, New York, NY  
 Ref. Struct.: 58-T316

**D.I.S.T.**  
Department of Structural Engineering  
University of Naples "Federico II"

OUTPUT STRENGTHENED SECTION									
CALCULATED STRESS, STRAINS, NEUTRAL AXIS, DESIGN FLEXURAL STRENGTH OF THE SECTION									
The neutral axis cuts the slab									
$y_c$	failure region	$\psi$	$\lambda$	$\sigma_s$	$\sigma_c$	$\sigma_r$	Solve	eq. Translation	$M_u$
[mm]		ad.	ad.	MPa	MPa	MPa			[kN m]
34,99	1	0,80	0,416	40,37	326,09	447,00		0,00	35,14
UNSTRENGTHENED SECTION									
$y_c$	$\sigma_s$	$\sigma_c$	$M_u$						
mm	MPa	MPa	kN m						
22	56,0	326,1	21,60						
				$\varepsilon_c =$	0,00045				
				$\varepsilon'_c =$	0,00019				
				$\varepsilon_s =$	0,00237				
				$\varepsilon_f =$	0,00263				

The technique proposed, using products from the MAPEWRAP SYSTEM line, is applied “in parallel” to the existing structure. It acts in conjunction with the structure rather than replaces it, so that by working together the strength and load-bearing capacity of the strained areas of the floor joists are increased without modifying the distribution or stiffness of the masses.

TYPE OF STRENGTHENING  $\Rightarrow$  No. 1 plate of CARBOPLATE E 170/100

Flexural capacity of the strengthened member:

$$M_{rd, \text{ ULS post-strengthening}} = 35.14 \text{ kN*m/joist} \Rightarrow M_{sd} < M_{rd}$$

### APPLICATION TECHNIQUE FOR “CARBOPLATE” PLATES

#### Procedure

For flexural strengthening of joists with CARBOPLATE, refer to the previous pages regarding flexural strengthening of beams.

(ref. “Design Guide” procedure **G.1.2** and technical specifications **G.1.2.1**, **G.1.2.2** and **G.1.2.3**)\*.

### APPLICATION TECHNIQUE FOR “MAPEWRAP” FABRICS USING THE “DRY TECHNIQUE” AND THE “WET TECHNIQUE”

#### Procedure

For flexural strengthening of joists with MAPEWRAP, refer to the previous pages regarding flexural strengthening of beams.

(ref. “Design Guide” procedure **G.1.3** and technical specifications **G.1.3.1** to **G.1.3.5**)\*.



Figure 4.5 - Flexural strengthening of joists using MAPEWRAP C UNI-AX fabric

Figure 4.6 - Flexural strengthening of joists using CARBOPLATE plates

Figure 4.7 - Flexural strengthening of joists using MAPEWRAP C UNI-AX fabric

### 4.3. Flexural strengthening of wooden beams

This type of strengthening may be achieved by applying one or more sheets of CARBOPLATE or one or more layers of uniaxial fabric, such as MAPEWRAP C UNI-AX, MAPEWRAP G UNI-AX or MAPEWRAP B UNI-AX, to the strained areas of the beam.

#### MAPEI FRP WOOD - DESIGN OF FLEXURAL STRENGTHENING FOR WOODEN BEAMS

The objective of the installation is to increase the load-bearing capacity of wooden beams due to a change in use that generates overloads.

Characteristics of the materials used in the calculation

- Depth of the beam:  $h = 320 \text{ mm}$ ;
- Width of the beam:  $b = 230 \text{ mm}$ ;

Design bending moment acting on the section:

- $M_{sd, ULS} = 95 \text{ kN}\cdot\text{m}$

## DESIGN/CALCULATION PROCEDURE: “WOOD FRP” CALCULATION

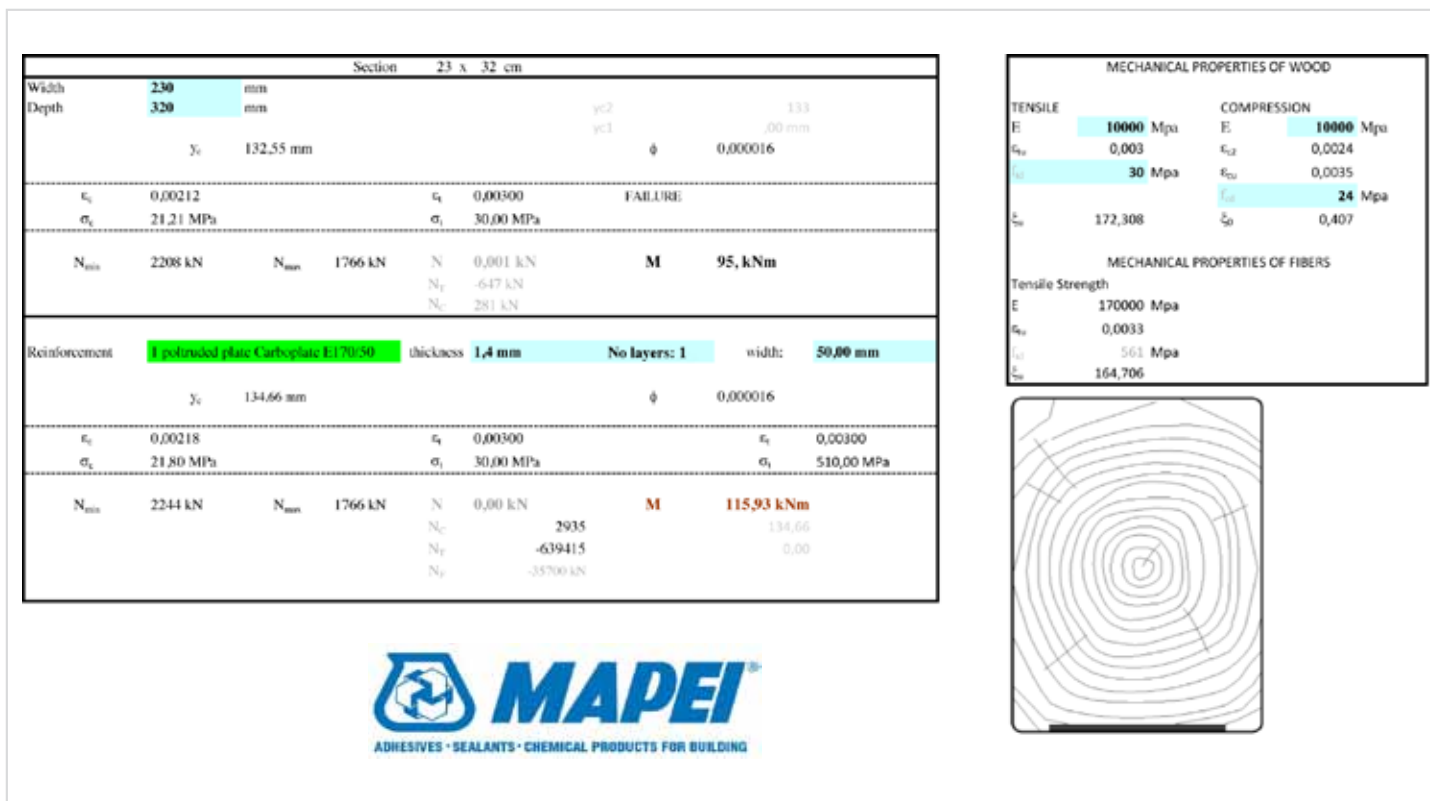

TYPE OF STRENGTHENING ➡ No. 1 plate of CARBOPLATE E 170/50

Flexural capacity of the strengthened member in the section after strengthening:

$$M_{rd, \text{ ULS post-strengthening}} = 115.93 \text{ kN*m} \quad \Rightarrow \quad M_{sd} < M_{rd}$$

### APPLICATION TECHNIQUE FOR “CARBOPLATE” PLATES

The plates may be applied by bonding them to the inner face of the wooden beam or by inserting them in specially cut seats (ref. ReLuis Guidelines 3.3.2.1.7).

#### Procedure

- 1) Support the floor slab with appropriate equipment to eliminate all stresses and any deformation caused.
- 2) Thoroughly clean the substrate to remove all traces of loose material from the surface.
- 3) Brush-apply a coat of MAPEWRAP PRIMER 100 (fluid epoxy impregnator in water dispersion for consolidating and priming wooden structures).

**4)** Apply a layer of MAPEWOOD PASTE 140 (thixotropic epoxy adhesive for structural consolidation of wooden members) on the inner face of the wooden beams to cover all the surfaces on which the plates are to be positioned.

**5)** Apply another layer of MAPEWOOD PASTE 140 in correspondence with the area where the plates are to be bonded, remove the protective plastic coating (peel-ply) from the plates of CARBOPLATE (pultruded carbon fibre plates pre-impregnated with epoxy resin) and position them on the inner face of each beam.

**6)** Apply a thin layer of MAPEWOOD PASTE 140 on the inner face of the plates that have just been positioned and dust the surface with dry quartz sand while the resin (MAPEWOOD PASTE 140) is still wet to create a rough surface.

(ref. "Design Guide" procedure **G.4.4** and technical specifications **G.4.4.1**, **G.4.4.2** and **G.4.4.3**)\*.

Figures 4.8 and 4.9 - Strengthening of wooden beams using CARBOPLATE plates - Palazzo Farnese, Italy



MAPEWOOD PRIMER 100	Component A	Component B
Mixing ratio	1	1
Density of mix (g/cm <sup>3</sup> )	1.08	
Brookfield viscosity of mix (mPa·s)	700	
Workability time at +23°C	30-40 mins.	
Application temperature range	from +10°C to +30°C	
Complete hardening time	12-24 hours	



MAPEWOOD PRIMER 100



MAPEWOOD GEL 120

MAPEWOOD GEL 120	Component A	Component B
Mixing ratio	4	1
Density of mix (g/cm <sup>3</sup> )	1.01	
Brookfield viscosity of mix (mPa·s)	11,400	
Workability time at +23°C	40 mins.	
Setting time at +23°C	50 mins.	
Application temperature range	from +10°C to +30°C	
Complete hardening time	7 days	
Tensile strength (ASTM D 638) (N/mm <sup>2</sup> )	30	
Tensile elongation (ASTM D 638)	1.2	
Flexural strength (ISO 178) (N/mm <sup>2</sup> )	60	
Flexural modulus of elasticity (ISO 178) (N/mm <sup>2</sup> )	2,000	
Compressive strength (ASTM D 695) (N/mm <sup>2</sup> )	65	
Compressive modulus of elasticity (ASTM D 695) (N/mm <sup>2</sup> )	5,000	



MAPEWOOD PASTE 140

MAPEWOOD PASTE 140	Component A	Component B
Mixing ratio	2	1
Density of mix (g/cm <sup>3</sup> )	1.5	
Brookfield viscosity of mix (mPa·s)	490,000	
Workability time at +23°C	60 mins.	
Setting time at +23°C	4-5 h	
Application temperature range	from +10°C to +35°C	
Complete hardening time	7 days	
Tensile strength (ASTM D 638) (N/mm <sup>2</sup> )	18	
Tensile elongation (ASTM D 638) (%)	1	
Flexural strength (ISO 178) (N/mm <sup>2</sup> )	30	
Flexural modulus of elasticity (ISO 178) (N/mm <sup>2</sup> )	4,000	
Compressive strength (ASTM D 695) (N/mm <sup>2</sup> )	45	
Compressive modulus of elasticity (ASTM D 695) (N/mm <sup>2</sup> )	3,000	

## 5. Shear strengthening

Shear strengthening is required for structural members when the shear stress applied is higher than the corresponding design shear resistance. Shear capacity of FRP-strengthened member must be calculated by also considering the role of the concrete and any transversal reinforcement present (ref. CNR DT 200/2004 par. 4.3).

$$V_{sd} \leq V_{rd}$$

Shear strengthening is achieved by bonding one or more layers of strips of fabric to the external surface of the member to be strengthened. The fabric may be bonded on the two sides of the beam using “U” shaped pieces and by wrapping fabric around the section of the beam. The strips may be applied in either an irregular pattern with gaps between each strip or by winding them continuously alongside each other.

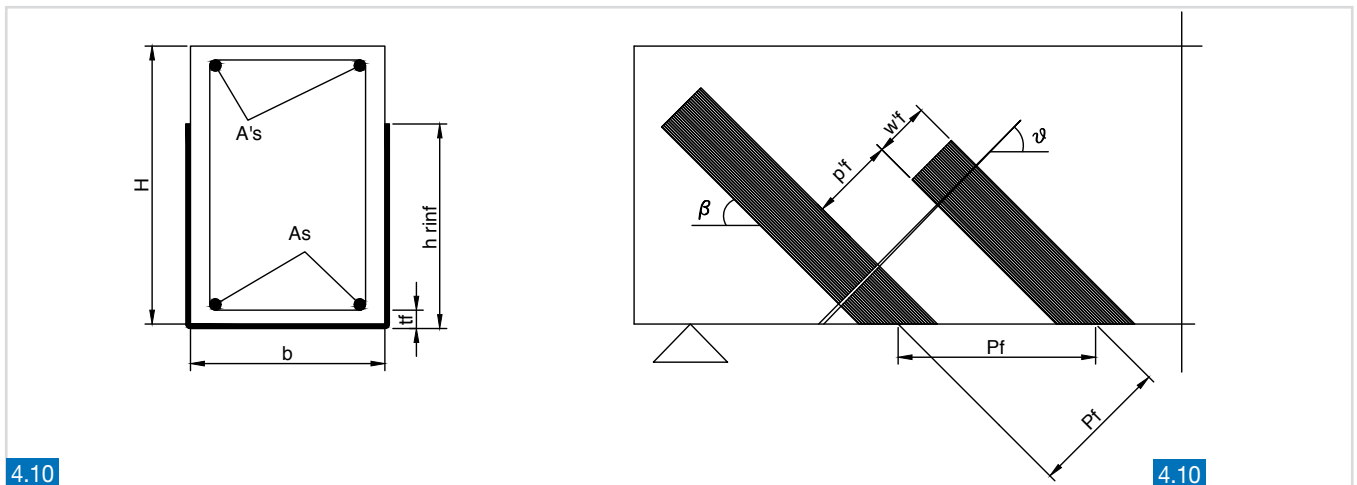

Figure 4.10 - Shear strengthening using composite fabrics

### 5.1. Shear strengthening of beams

This type of strengthening may be achieved by applying one or more layers of uniaxial fabric, such as MAPEWRAP C UNI-AX, MAPEWRAP C UNI-AX HM, MAPEWRAP C BI-AX, MAPEWRAP C QUADRI-AX, MAPEWRAP G UNI-AX, MAPEWRAP B UNI-AX or MAPEWRAP S FABRIC.

#### MAPEI FRP FORMULA - DESIGN OF SHEAR STRENGTHENING FOR A “T” SECTION BEAM

The objective of the intervention is to supplement the stirrups in a beam.

Characteristics of the materials used in the calculation

- Width of slab:  $W = 500 \text{ mm}$ ;
- Width of web:  $b = 300 \text{ mm}$ ;
- Depth of member:  $H = 450 \text{ mm}$ ;
- Depth of slab:  $h = 100 \text{ mm}$
- Stirrups:  $\varnothing 6/25 \text{ mm}$
- Steel: FeB38k ( $f_{yk} \geq 375 \text{ N/mm}^2$ )
- Concrete class: C 20/25 ( $R_{ck} 25 \text{ N/mm}^2$ )

Design shear force acting on the section:

- $V_{sd} = 75 \text{ kN}$

USER INPUT	
Cross Section Properties	
Width of slab (L)	500 mm
Width of web (b <sub>w</sub> )	300 mm
Depth of member (H)	450 mm
Depth of slab (h)	100 mm
Effective depth (d)	430 mm
Depth of web (h <sub>w</sub> )	350 mm
Cover (d <sub>1</sub> =d <sub>2</sub> )	20 mm
Diameter of the stirrups	Φ 6
A <sub>stirrups</sub>	28 mm <sup>2</sup>
Spacing of stirrups	250 mm
Arms of the stirrups	2
Corner radius (Rc)	20 mm

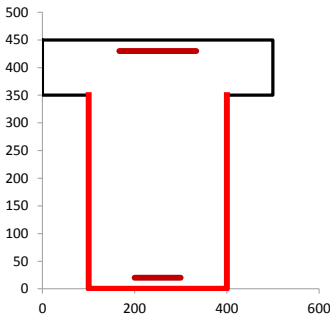



ADHESIVES • SEALANTS • CHEMICAL PRODUCTS FOR BUILDING

Technical Assistance - Structural Strengthening Line

Customer: Eng. Chris Keapple  
 Yard: Frnt 1, 72 Bedford Street, New York, NY  
 Ref. Struct.: 58-T316



**D.I.ST.**  
 Department of Structural Engineering  
 University of Naples "Federico II"

Materials Properties			Design stress	elasticity	$\gamma_c = 1.5$
			MPa	GPa	$\gamma_s = 1.15$
concrete class	C 20/25	▼	11,76	30,2	$f_{yk} = 20,75 \text{ MPa}$
steel	FeB 38 k	▼	326,1	210	$f_{yk} = 375 \text{ MPa}$
					$f_{cm} = 24,7 \text{ MPa}$
					$\epsilon_{yk} = 0,0016$
					$\epsilon_{uk} = 0,01$

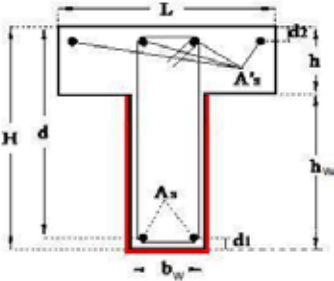



## SELECTING THE APPROPRIATE STRENGTHENING

FRP System	Strengthening systems	Exposure Conditions
MaPeWrap C UNI-AX 600 - E 256	Certified strengthening systems	Interior exposure
Type of longitudinal reinforcement	Type of transversal reinforcement	Fiber type
Continuos	U Wrap	Carbon

FRP Properties	
$\sigma$ ultimate tensile strength	5340 MPa
Modulus of elasticity	256 GPa
$\varepsilon$ ultimate rupture strain, $\varepsilon_{frp,u}$	0,021
Thickness per ply	0,328 mm

$\beta$	90°
$\theta$ angle of shear cracks	45°
Number of plies of FRP reinforcement ( $n_f$ )	1

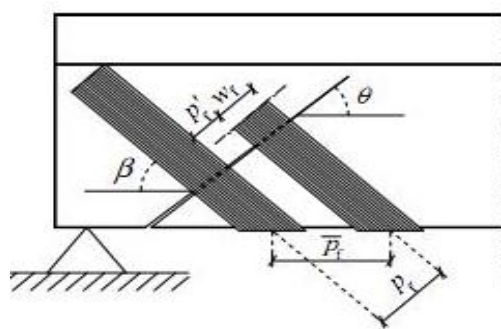

Calculation	
$A_{sw}$	57 mm <sup>2</sup>
$\omega_{sw}$	0,0209
$\cot \theta$ (design) NTC 2008	2,500
$v$	0,50
$\alpha_c$	1,000
$\gamma_{R,d}$ Partial factor for resistance models	1,2
$\eta_a$ Environmental reduction factor	0,95
$f_{fd}$ Design strength of FRP reinforcement	4611,8 MPa
$K_b$	1,000
$\Phi_R$	0,307
$\min \{0,9d ; h_w\}$	350 mm
$t_f$ Thickness per ply	0,328
$\gamma_f$ Redution factor FRP	1,1
$\gamma_{f,d}$ Coefficiente parziale per i materiali	1,2
$f_{fdd}$ Design debonding strength of FRP	377,8 MPa
$l_e$ Optimal bond length	136 mm
$f_{fed}$ Effective design strength of FRP	328,77 MPa
$V_{Rd,f}$	<b>69,6 kN</b>

OUTPUT UNSTRENGTHENED SECTION	
$V_{Rsd} = 71,33$ kN	Steel contribution to the shear capacity
$V_{Rcd} = 235,37$ kN	Concrete contribution to the shear capacity
$V_{Rd,UNSTRENGTHENED SECTION} = 71,33$ kN	<b>Shear capacity of FRP-unstrengthened member</b>
$V_{Rd} = 140,88$ kN	<b>Shear capacity of FRP-strengthened member</b>

TYPE OF STRENGTHENING  $\Rightarrow$  MAPEWRAP C UNI-AX 600 fabric

Shear capacity of FRP-strengthened member:

$V_{rd, post-strengthening} = 140.88$  kN  $\Rightarrow$   $V_{sd} < V_{rd}$

## **APPLICATION TECHNIQUE FOR “MAPEWRAP” FABRICS USING THE “WET TECHNIQUE”**

### *Procedure*

- 1)** Prepare the substrate (as per procedure on page 26).
- 2)** Remove all sharp corners and create a rounded edge with a radius of at least 20 mm (in compliance with CNR DT 200/2004 par. 4.3.3.3).
- 3)** Apply an even coat of MAPEWRAP PRIMER 1 by brush or with a roller. If the substrate is particularly absorbent, apply a second coat of primer once the previous one has been completely absorbed.
- 4)** Skim and even out the surface with a 1 to 2 mm thick layer of MAPEWRAP 11 applied with a notched trowel while the MAPEWRAP PRIMER 1 is still wet. If epoxy adhesive with a longer workability time is required, MAPEWRAP 12 may be used.
- 5)** Smooth over the surface of the adhesive with a flat trowel to eliminate even the smallest irregularities from the surface. Fill and round off the corners with the same product to create a rounded edge with a radius of at least 20 mm (in compliance with CNR DT 200/2004 par. 4.3.3.3).
- 6)** Impregnate the pieces of fabric before laying them on the surface. This step may be carried out either manually or with suitable tools and equipment. For manual impregnation, cut the MAPEWRAP fabric to the size required with scissors and soak it for a few minutes in a plastic container (preferably rectangular) filled to around 1/3 with MAPEWRAP 21. Remove the fabric from the container, leave it to drip for a few seconds and then press it lightly without twisting to completely remove all the excess resin. Wear protective rubber gloves when carrying out this operation. As an alternative to manual impregnation, simple equipment with a bowl and a series of rollers may be used; this makes it easier and safer for the operator to saturate the fabric and remove the excess resin. This system is particularly recommended when a large number of interventions on large surfaces need to be carried out and guarantees that the resin is distributed evenly in every part of the fabric.
- 7)** Position the MAPEWRAP fabric immediately after impregnation, making sure that it is spread on evenly without creases. Wear protective rubber gloves for this operation.
- 8)** Go over the surface of the fabric with a MAPEWRAP ROLLER to make sure

the adhesive and resin completely penetrate through the fibres. This operation is also necessary to eliminate air bubbles trapped in the fabric.

**9)** Wash the MAPEWRAP ROLLER with thinners immediately after use.

(ref. “Design Guide” procedure **G.1.4** and technical specifications **G.1.4.1** to **G.1.4.7**)\*.

### **APPLICATION TECHNIQUE FOR “MAPEWRAP” FABRICS USING THE “DRY TECHNIQUE”**

#### Procedure

- 1)** Prepare the substrate (*as per procedure on page 26*).
- 2)** Remove all sharp corners and create a rounded edge with a radius of at least 20 mm (in compliance with CNR DT 200/2004 par. 4.3.3.3).
- 3)** Apply an even coat of MAPEWRAP PRIMER 1 by brush or with a roller. If the substrate is particularly absorbent, apply a second coat of primer once the previous one has been completely absorbed.
- 4)** Skim and even out the surface with a 1 to 2 mm thick layer of MAPEWRAP 11 applied with a notched trowel while the MAPEWRAP PRIMER 1 is still wet. If epoxy adhesive with a longer workability time is required, MAPEWRAP 12 may be used.
- 5)** Smooth over the surface of the adhesive with a flat trowel to eliminate even the smallest irregularities from the surface. Fill and round off the corners with the same product to create a rounded edge with a radius of at least 20 mm (in compliance with CNR DT 200/2004 par. 4.3.3.3).
- 6)** Apply an even coat of MAPEWRAP 31 with a brush or short-haired roller on the MAPEWRAP 11 or MAPEWRAP 12 while it is still wet.
- 7)** Position “U” shaped pieces of MAPEWRAP fabric immediately after applying the resin, making sure that it is spread on evenly without creases. Wear protective rubber gloves for this operation.
- 8)** Go over the surface of the fabric with a MAPEWRAP ROLLER to make sure the adhesive and resin completely penetrate through the fibres. This operation is also necessary to eliminate air bubbles trapped in the fabric.

9) Apply another coat of MAPEWRAP 31 on the MAPEWRAP fabric. Go over the surface of the impregnated fabric with a MAPEWRAP ROLLER to eliminate air bubbles trapped in the fabric.

10) If a different product is to be applied on the surface of the fabric, we recommend sprinkling a layer of sand over the MAPEWRAP 31 while it is still wet.

(ref. “Design Guide” procedure **G.1.4** and technical specifications **G.1.4.1** to **G.1.4.7**)\*.

Figure 5.1 - Shear strengthening of a reinforced concrete beam



## 5.2. Shear/tensile strengthening of masonry structures

The strengthening of masonry structures (vertical members and vaults) may be achieved by applying the composite **Mapei FRG System** which consists of pre-primed, alkali-resistant A.R. glass fibre mesh (MAPEGRID G 220) or pre-primed basalt fibre mesh (MAPEGRID B 250), and an inorganic, cement-based matrix (PLANITOP HDM / PLANITOP HDM MAXI) or lime-based matrix (PLANITOP HDM RESTAURO).

The need for sustainable renovation installations to upgrade weak constructions and the intrinsic mechanical characteristics of masonry has led to the study and development of innovative structural strengthening materials and technology that are more compatible with the physical and mechanical characteristics of masonry and its intrinsic durability. Recent developments in the standardisation

system also imply installations using innovative materials to upgrade weak areas that are located in buildings and structures after an assessment of their structural capacity. These include employing strengthening techniques based on the use of composites, which offer a number of significant advantages (high mechanical properties, low architectonic impact, high durability, ease of application and reversibility) for countries with such a rich patrimony of historical buildings and monuments as Italy. The application of this type of system overcomes the problem of the inherently low tensile strength of masonry and increases the overall ductility of structures.

This innovative, technologically advanced consolidating system is used in this sector through a series of inorganic matrix composites developed by Mapei, consisting of pre-primed, alkali-resistant (A.R.) glass fibre mesh (MAPEGRID G 220) or pre-primed basalt fibre mesh (MAPEGRID B 250) positioned on the structure using two-component, high ductility, fibre reinforced cementitious mortar (PLANITOP HDM / PLANITOP HDM MAXI) or two-component, high ductility, ready-mixed hydraulic lime (NHL) and Eco-pozzolan-based mortar (PLANITOP HDM RESTAURO). Also, recent developments in composites, in which the matrix is made up of a base of eco-compatible pozzolan, allows these types of material to be used even on listed and historical buildings and monuments.

The success of these systems on masonry structures has been evaluated by means of a “laboratory test campaign” carried out at the Department of Structural Analysis and Design at the “Federico II” University of Naples.



5.2



Figures 5.2 and 5.3 - Strengthening on the outer face of stone vaults using PLANITOP HDM MAXI and MAPEGRID G 220

### **5.2.1. Laboratory testing: “Diagonal compression tests on tuff masonry panels strengthened with CMF: PLANITOP HDM + MAPEGRID G 220”**

Testing was carried out on tuff masonry panels made with specially prepared construction mortar to reproduce the mechanical characteristics of the pozzolan-based mortar used on ancient monuments and buildings in the south of Italy’s area. Strengthened panels and panels without strengthening were then subjected to diagonal compression tests. The strengthening system was made of a pre-primed, alkali-resistant (A.R.) glass fibre mesh (MAPEGRID G 220) and a matrix based on a two-component, high ductility, fibre reinforced, pozzolanic-reaction cementitious mortar (PLANITOP HDM).

#### **TEST RESULTS**

The results of the tests demonstrated that the strengthening offered considerable benefits in terms of shear strength and ductility, and also had the capacity to distribute loads to limit the extremely fragile post-peak behaviour of the strengthened member, with significant advantages in the event of seismic activity. On the panels without strengthening, the tension induced by the loads generated cracks mainly along the surface of the tuff/mortar interface rather than in the direction of the load applied.

Failure was characterised by the beds of mortar slipping from the tuff stones. The presence of strengthening materials on both wall faces, on the other hand, modified the failure mode of the panels, moving the shear failure caused by the mortar slipping to shear failure characterised by widespread cracking in the direction of the compressive load, with small to medium size cracks intercepting both the layers of mortar and the tuff stones.

*Figure 5.4 - A panel with a strengthening system applied: MAPEGRID G220 + PLANITOP HDM*



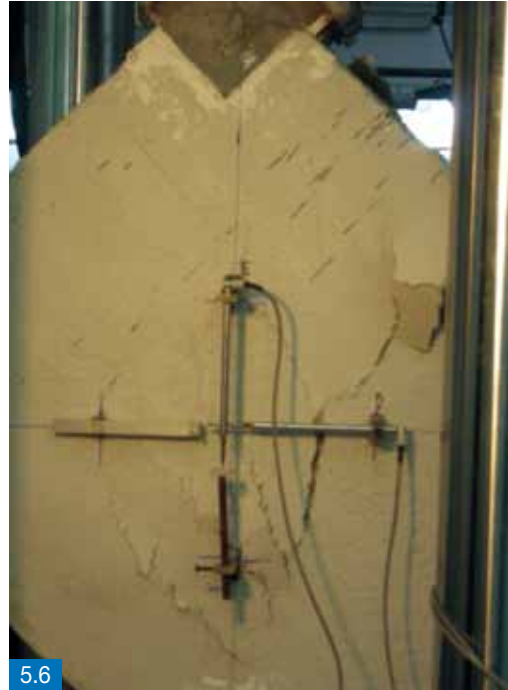

Figures 5.5 and 5.6 - Diagonal compressive strength test

The strengthening on both faces of the wall, therefore, managed to change the distribution of the tension over the entire surface of the wall. The tensile properties of the strengthening system were clearly visible through the presence of widespread micro cracking along the outer layer of mortar distributed on both faces of the wall, with a sub-vertical trend along the compressed diagonals of the wall. Graph 1 shows the stress-deformation behaviour of each sample

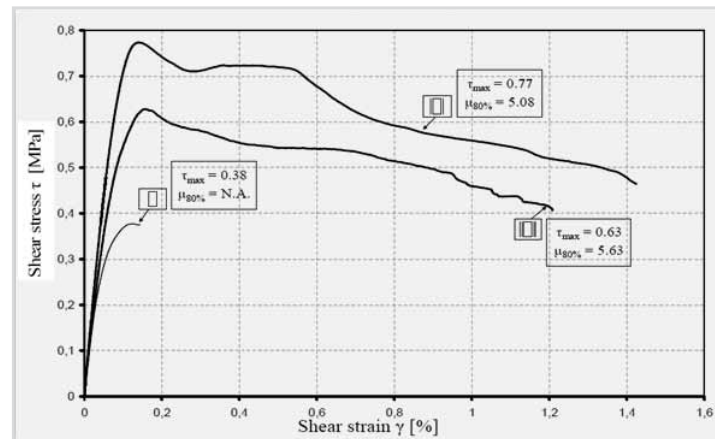

Figure 5.7 - The behaviour of a strengthened masonry panel

Figure 5.8 - The behaviour of a masonry panel without strengthening

and, apart from a marked increase in maximum tension, the capacity of the strengthened panels to deform considerably more than the panels without strengthening is evident. The positive effect of the strengthening on the masonry is even more evident if we compare the areas below their relative tension-deformation curves. This comparison highlights the increased capacity of the strengthened samples to dissipate energy, a property that is particularly important in the event of seismic activity. The formation of a series of small cracks, as shown in Graph 1, allows the masonry panel to dissipate more energy and to deform much more without losing its resistance. Also, as far as stiffness is concerned, a single layer of strengthening means that it remains practically the same.

Graph 1 - The mechanical behaviour of a panel strengthened with the "reinforced" PLANITOP HDM + MAPEGRID G 220 system



The results obtained allow us to make the following observations:

- from an examination of the values of shear strength obtained by the various panels, there is a net improvement in the load-bearing capacity of masonry with a strengthening system;
- in the post-peak phase, the strengthening system allowed a high level of resistance to shear deformation to be maintained for a sufficiently long period in all cases;
- the presence of a strengthening system delayed cracking being triggered off and increased tension at the elastic limit of the panels;
- a strengthening system allows ductility to be increased considerably (around 140%) compared with the behaviour of panels without strengthening; also, ductility was around 2.25 times higher than the values obtained with samples without strengthening.



## 5.2.2. Laboratory testing: “Diagonal compression tests on tuff masonry panels strengthened with CMF: PLANITOP HDM RESTAURO + MAPEGRID G 220 and PLANITOP HDM RESTAURO + MAPEGRID B 250”

In this case too diagonal compression tests were carried out on tuff masonry panels built in the same way as the previous examples. Diagonal compression tests were carried out on panels without strengthening and on panels with a strengthening system comprising mortar reinforced with pre-primed, alkali-resistant (A.R.) glass fibre mesh (MAPEGRID G 220) and a matrix of two-component, ready-mixed, high ductility hydraulic lime (NHL) and Eco-pozzolan based mortar (PLANITOP HDM RESTAURO). Panels strengthened with pre-primed basalt fibre mesh (MAPEGRID B 250) were also tested.

### TEST RESULTS

The following graphs show the relative curves of various strengthening systems, from which we can deduce how the “LIME+GLASS” system (PLANITOP HDM RESTAURO + MAPEGRID G 220) considerably increases shear strength (Graph 2), comparable to the “CEM+GLASS” system (PLANITOP HDM + MAPEGRID G 220), while the “LIME+BASALT” system (PLANITOP HDM RESTAURO + MAPEGRID B 250), apart from increasing the shear strength of the panel to a lower degree than the “LIME+GLASS” system (PLANITOP HDM RESTAURO + MAPEGRID G 220), notably increases its ductility (indicated by an extension in the branch of the curve).



Figures 5.9 and 5.10 -  
Diagonal compressive  
strength test

Graph 2 - The mechanical behaviour of panels strengthened with a system made from basalt and glass fibre mesh

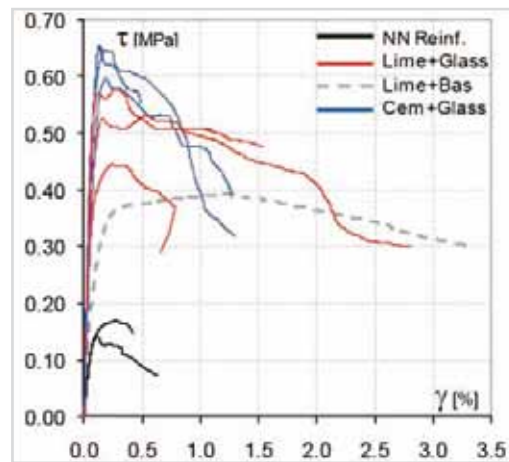

Graph 3 - The behaviour of tuff panels strengthened with MAPEGRID B 250 and PLANITOP HDM RESTAURO

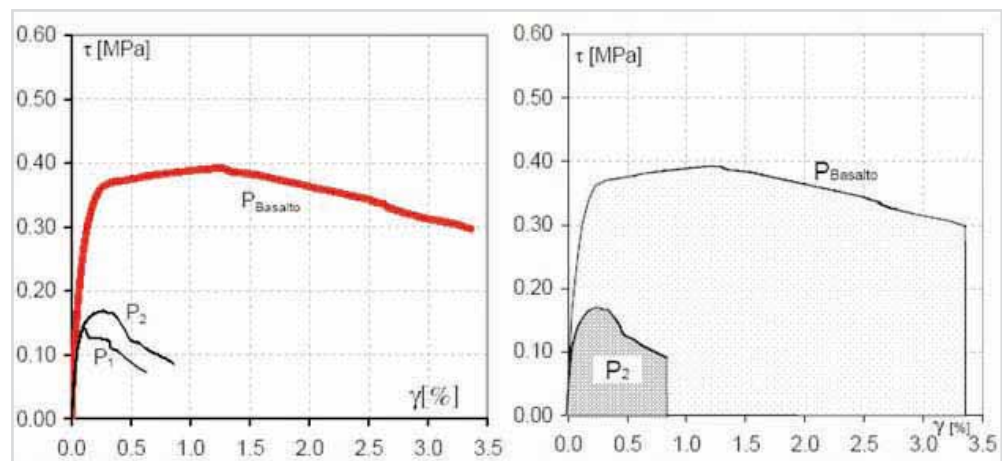

### APPLICATION TECHNIQUE FOR FRG SYSTEMS ON MASONRY MEMBERS (SHEAR STRENGTHENING FOR WALLS) (ref. RELUIS GUIDELINES par. 3.2.4.3)

#### Procedure

The application of a strengthening system is made on the presumption that the substrate has undergone adequate preparation and has no loose material or mechanically weak layers.

#### **Shear strengthening of bay walls using the PLANITOP HDM / PLANITOP HDM MAXI + MAPEGRID G 220 (or MAPEGRID B 250) system**

- 1)** Level off the substrates to form a sufficiently flat layer with two-component, high ductility, fibre reinforced, pozzolanic-reaction cementitious mortar (PLANITOP HDM / PLANITOP HDM MAXI).
- 2)** Apply pre-primed, alkali-resistant (A.R.) glass fibre strengthening mesh (MAPEGRID G 220) or pre-primed basalt fibre mesh (MAPEGRID B 250).

**3)** Apply a second layer of PLANITOP HDM /PLANITOP HDM MAXI mortar so that it completely covers the strengthening mesh evenly.

(ref. “Design Guide” procedure **G.2.6** and technical specifications **G.2.6.1** and **G.2.6.2**)\*.

### **Shear strengthening of bay walls using the PLANITOP HDM RESTAURO + MAPEGRID G 220 (or MAPEGRID B 250) system.**

**1)** Level off the substrates to form a sufficiently flat layer with two-component, high ductility, fibre reinforced natural hydraulic lime (NHL) and Eco-pozzolan based mortar (PLANITOP HDM RESTAURO).

**2)** Apply pre-primed, alkali-resistant A.R. glass fibre strengthening mesh (MAPEGRID G 220) or pre-primed basalt fibre mesh (MAPEGRID B 250).

**3)** Apply a second layer of PLANITOP HDM RESTAURO mortar so that it completely covers the strengthening mesh evenly.

(ref. “Design Guide” procedure **G.2.6** and technical specifications **G.2.6.3** and **G.2.6.4**)\*.



Figures 5.11 and 5.12 -  
Strengthening system on the outer  
face of the vaulted roofs of the  
Church of the Padre Pio Giovane  
Convent - Serracapriola  
(Foggia - Italy)

## 6. Confinement of columns

Confinement of reinforced concrete members with FRP is commonly used for static strengthening and seismic upgrading. Adequate confinement of reinforced concrete columns may determine an improvement in both the ultimate compressive strength and ductility of a structural member. Reinforced concrete members may be confined by winding FRP fabric around them to form a continuous external bandage (covered) or by staggering the fabric (banding). The slope of the fibres with respect to the longitudinal axis of the member may vary from 0° to 180° (ref. CNR DT 200/2004 par. 4.5). The design of FRP strengthening to increase the balanced design compressive strength or slightly eccentric design compressive strength of a reinforced concrete pillar must guarantee that the design value of the axial capacity of a FRP-confined concrete member  $N_{Rcc,d}$  is such that the following conditions are satisfied:

$$N_{Rcc,d} \geq N_{Sd}$$

in which  $N_{Sd}$  is the factored axial force acting on the member.

### 6.1. Confinement of reinforced concrete columns

This type of strengthening may be achieved by applying one or more layers of uniaxial fabric, such as MAPEWRAP C UNI-AX or MAPEWRAP C UNI-AX HM, to increase compressive strength and ductility. Confinement is carried out using MAPEWRAP G UNI-AX and MAPEWRAP B UNI-AX if only ductility needs to be increased.

#### MAPEI FRP FORMULA - DESIGN OF CONFINEMENT OF CONCRETE COLUMNS

The objective of the installation is to increase the compressive strength of a reinforced concrete pillar.

##### Characteristics of the materials used in the calculation

- Depth of member:  $H = 450 \text{ mm}$ ;
- Width of member:  $b = 450 \text{ mm}$ ;
- Area of longitudinal reinforcement:  $6 \text{ } \varnothing 16 \text{ mm} \approx 1205.76 \text{ mm}^2$
- Steel: FeB38k ( $f_{yk} \geq 375 \text{ N/mm}^2$ )
- Concrete class: C 16/20

Factored axial force acting on the section:

- $N_{Sd} = 2800 \text{ kN*m}$

## SELECTING THE APPROPRIATE STRENGTHENING

User input		
Cross Section Properties		
Cross Section	Non Circular	
Depth of member (H)	450	mm
Width of member (B)	450	mm
Gross Area Section (A <sub>g</sub> )	202500	mm <sup>2</sup>
Cover (d)	30	mm
Area of longitudinal reinforcement A <sub>st</sub>	1205,76	mm <sup>2</sup>
Corner radius (rc)	20	mm



**MAPEI**  
ADHESIVES · SEALANTS · CHEMICAL PRODUCTS FOR BUILDING

**Technical Assistance - Structural Strengthening Line**  
Customer: Eng. Chris Keapple  
Yard: Frnt 1, 72 Bedford Street, New York, NY  
Ref. Struct.: 58-T316

Materials Properties		Design stress		
		MPa		
concrete class	C 16/20	9,41	γ <sub>c</sub> =	1,5
steel	FeB 38 k	326	γ <sub>s</sub> =	1,15

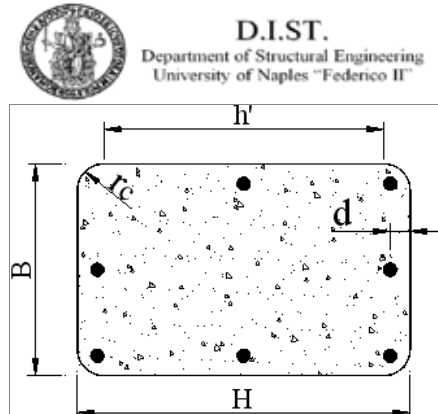

FRP System	Fiber Type	Exposure Conditions
MapeWrap C UNI-AX 600 - E 256	Carbon	Aggressive environment
Strengthening systems		Reinforcement configuration
Certified strengthening systems		Continuous

FRP Properties		
σ rupture	5340 MPa	N° of plies (n)   1
Modulus of elasticity	256000 MPa	
Thickness per ply (t <sub>f</sub> )	0,328 mm	
ε rupture, ε <sub>frp,u</sub>	0,021	
ε design, ε <sub>rd,rid</sub> : (strenght)	0,004	
ε design, ε <sub>rd,rid</sub> : (ductility)	0,013	
Reduction factor FRP (γ <sub>f</sub> )	1,1	
Environmental reduction factor (η <sub>a</sub> )	0,85	
Partial factor for resistance model (γ <sub>R,d</sub> )	1,1	

ρ <sub>f</sub>	0,00292
k <sub>H</sub>	0,45
k <sub>v</sub>	1,00
k <sub>γ</sub>	1,00
k <sub>eff</sub>	0,45

Ductility of FRP-confined members under combined bending and axial load	
f <sub>1</sub>	4,67
f <sub>1,eff</sub>	2,086
<b>ε<sub>ccu</sub></b>	<b>10,56 ‰</b>
Axial capacity of FRP-confined members under concentric or slightly eccentric force	
f <sub>1</sub>	1,49
f <sub>1,eff</sub>	0,667
<b>f<sub>ccd</sub></b>	<b>13,60 MPa</b>
f <sub>1,eff</sub> /f <sub>cd</sub>	0,07

<b>N<sub>Rcc,d</sub></b>	<b>2895,9 kN</b>
--------------------------	------------------

Existing Axial Compressive Strength	
N <sub>Re,d</sub>	2298,0 kN

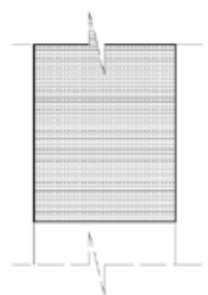

TYPE OF STRENGTHENING ➡ MAPEWRAP C UNI-AX 600 fabric

The axial capacity of FRP-confined concrete member on the section after strengthening:

$$N_{Rcc,d} \text{ (POST-STRENGTHENING)} = 2895.9 \text{ kN*m} \quad \Rightarrow \quad N_{sd} < N_{Rcc,d}$$



Figure 6.1 - Confinement of a reinforced concrete panel using uniaxial carbon fibre (MAPEWRAP C)

Figure 6.2 - Confinement of reinforced columns and cladding around beam-column hinge zones

## APPLICATION TECHNIQUE FOR “MAPEWRAP” FABRICS USING THE “WET TECHNIQUE”

### Procedure

- 1) Prepare the substrate (as per procedure on page 26).
- 2) Remove all sharp corners and create a rounded edge with a radius of at least 20 mm (in compliance with CNR DT 200/2004 par. 4.5.2.1.2).
- 3) Apply an even coat of MAPEWRAP PRIMER 1 by brush or with a roller. If the substrate is particularly absorbent, apply a second coat of primer once the previous one has been completely absorbed.
- 4) Skim and even out the surface with a 1 to 2 mm thick layer of MAPEWRAP 11 applied with a notched trowel while the MAPEWRAP PRIMER 1 is still wet. If epoxy adhesive with a longer workability time is required, MAPEWRAP 12 may be used.
- 5) Smooth over the surface of the adhesive with a flat trowel to eliminate even the smallest irregularities from the surface. Using the same product, fill and round off the corners so they have a radius of at least 20 mm.
- 6) Impregnate the pieces of fabric before laying them on the surface. This step may be carried out either manually or with suitable tools and equipment.

For manual impregnation, cut the MAPEWRAP fabric to the size required with scissors and soak it for a few minutes in a plastic container (preferably rectangular) filled to around 1/3 with MAPEWRAP 21. Remove the fabric from the container, leave it to drip for a few seconds and then press it lightly without twisting to completely remove all the excess resin. Wear protective rubber gloves when carrying out this operation. As an alternative to manual impregnation, simple equipment with a bowl and a series of rollers may be used; this makes it easier and safer for the operator to saturate the fabric and remove the excess resin. This system is particularly recommended when a large number of interventions on large surfaces need to be carried out and guarantees that the resin is distributed evenly in every part of the fabric.

**7)** Position the MAPEWRAP fabric immediately after impregnation, making sure that it is spread on evenly without creases. Wear protective rubber gloves for this operation. Apply the fabric so that the sheets overlap each other by 50 mm on the vertical sides and 200 mm on the horizontal sides to guarantee efficient confinement.

**8)** Go over the surface of the fabric with a MAPEWRAP ROLLER to make sure the adhesive and resin completely penetrate through the fibres. This operation is also necessary to eliminate air bubbles trapped in the fabric.

**9)** Wash the MAPEWRAP ROLLER with thinners immediately after use.

*(ref. "Design Guide" procedure **G.1.5** and technical specifications **G.1.5.1** and **G.1.5.2** and procedure **G.1.6** and technical specifications **G.1.6.1** and **G.1.6.2**)\*.*

## **APPLICATION TECHNIQUE FOR "MAPEWRAP" FABRICS USING THE "DRY TECHNIQUE"**

### Procedure

**1)** Prepare the substrate.

**2)** Remove all sharp corners and create a rounded edge with a radius of at least 20 mm (in compliance with CNR DT 200/2004 par. 4.5.2.1.2).

**3)** Apply an even coat of MAPEWRAP PRIMER 1 by brush or with a roller. If the substrate is particularly absorbent, apply a second coat of primer once the previous one has been completely absorbed.

**4)** Skim and even out the surface with a 1 to 2 mm thick layer of MAPEWRAP 11 applied with a notched trowel while the MAPEWRAP PRIMER 1 is still wet If

epoxy adhesive with a longer workability time is required, MAPEWRAP 12 may be used.

**5)** Smooth over the surface of the adhesive with a flat trowel to eliminate even the smallest irregularities from the surface. Using the same product, fill and round off the corners so they have a radius of at least 20 mm.

**6)** Apply an even coat of MAPEWRAP 31 with a brush or short-haired roller over the MAPEWRAP 11 or MAPEWRAP 12 while it is still wet.

**7)** Position the MAPEWRAP fabric immediately after applying the resin, making sure that it is spread on evenly without creases. Wear protective rubber gloves for this operation. Apply the fabric so that the sheets overlap each other by 50 mm on the vertical sides and 200 mm on the horizontal sides to guarantee efficient confinement.

**8)** Go over the surface of the fabric with a MAPEWRAP ROLLER to make sure the adhesive and resin completely penetrate through the fibres. This operation is also necessary to eliminate air bubbles trapped in the fabric.

**9)** Apply another coat of MAPEWRAP 31 on the MAPEWRAP fabric. Go over the surface of the impregnated fabric with a MAPEWRAP ROLLER to eliminate air bubbles trapped in the fabric.

**10)** If any other product is to be applied on the surface of the fabric, we recommend dusting the MAPEWRAP 31 with sand while it is still wet.

*(ref. "Design Guide" procedure G.1.5 and technical specifications G.1.5.1 and G.1.5.2 and procedure G.1.6 and technical specifications G.1.6.1 and G.1.6.2)\*.*

## **7. Seismic upgrading**

Seismic upgrading of structures includes:

- LOCALISED STRENGTHENING OF BEAM/PILLAR HINGE ZONES
- STRENGTHENING FOR MASONRY ARCHES AND VAULTS
- LINTEL BANDS
- ANCHORING ROPES
- INTERVENTIONS ON NON LOAD-BEARING STRUCTURES
- INTERVENTIONS ON DAMAGED OR DEFICIENT VERTICAL STRUCTURAL MEMBERS IN INDUSTRIAL BUILDINGS



### **7.1. Properties of strengthening systems for the seismic upgrading of structures**

The aim of seismic upgrading is to eliminate the fragile collapse mechanisms of load-bearing members, the collapse mechanisms of floors along their plane and to improve the overall deformation capacity of structures.

Composite materials from the **Mapei FRP System** and **FRG System** lines are used to achieve these objectives and, thanks to their strength, low weight and ease of application, they are used for installations on critical areas of structures.

These objectives are generally reached by increasing the ductility of the hinge zones in reinforced concrete structures and restoring the box-like behaviour of load-bearing wall structures. This makes them more resistant to horizontal loads by eliminating the orthogonal forces acting on the masonry panels and by connecting the perpendicular load-bearing members together.

### **7.2. Localised strengthening of column beam junction**

Improving the mechanical performance characteristics of existing reinforced concrete structures, designed when anti-seismic requirements and prescriptions were not mandatory and so built to support vertical loads only, represents a problem that has heavy social and economic repercussions in the Mediterranean area structures. The overall behaviour of concrete frame is often unsatisfactory, in that they lack the required ductility and a dependable hierarchy of structural and/or mechanical resistance, thus inducing global collapse mechanisms. Recent seismic events have highlighted the numerous problems that occur in column/beam junction due to the formation of hinge points with a plastic behaviour at the top or base of pillars. The low amount of confinement of pillars, due to the presence of too few stirrups or stirrups that have splayed out of position, creates a flexural crisis at the top or on base of the pillar resulting in the non-confined concrete being compressed and crushed, instability in the reinforcing bars under compression and slipping of those in tension. The absence of stirrups in the column/beam junction in particular, and especially those positioned externally, may give rise to a more localised crisis due to shear failure of the panel. Therefore, in order to guarantee more adequate behaviour from this type of system in the event of seismic activity and to increase its overall ductility, in compliance with national guidelines (ReLuis Guidelines), the shear strength of the beams and pillars where they intersect at the junction is increased and the ends of the pillars, where more ductility under compressive/flexural loads is required, are confined.

The types of installation that improve the performance characteristics of column/beam junction in compliance with ReLuis Guidelines (Chapter 3) are as follows:

- 1) The load-bearing capacity of the junction panel and the resistance of the top portion of the pillar to shear forces from buffer walls are increased by applying strips of uniaxial metal fibre fabric (MAPEWRAP S FABRIC) diagonally around the hinge point (Figure 7.1). This phase also includes the application of quadriaxial carbon fibre fabric (MAPEWRAP C QUADRI-AX) in an “L” formation at the intersection between the beam and pillar (Figure 7.2).

Figure 7.1 - Diagrams from chapter 3 of the ReLuis Guidelines

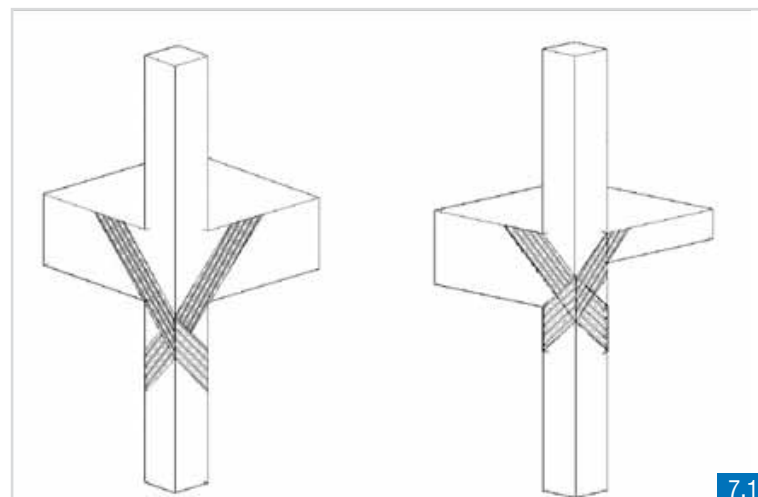
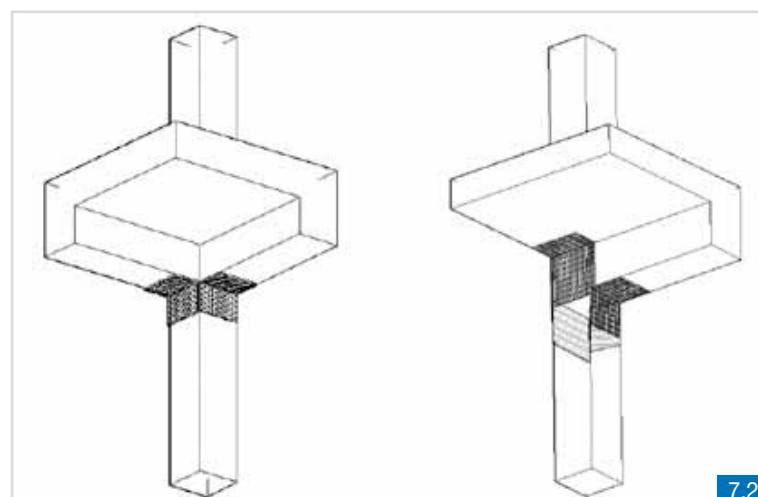

Figure 7.2 - Diagrams from chapter 3 of the ReLuis Guidelines



**2)** The shear strength of the junction panel is increased by applying balanced quadriaxial carbon fibre fabric (MAPEWRAP C QUADRI-AX) to the junction zone (Figure 7.3).

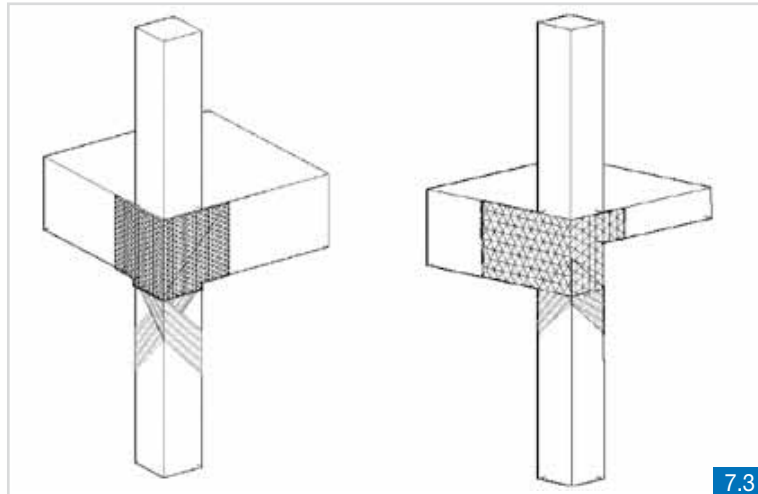

Figure 7.3 - Diagrams from chapter 3 of the ReLuis Guidelines

**3)** Confinement of the ends of the pillars is carried out by wrapping them with uniaxial carbon fibre fabric (MAPEWRAP C UNI-AX), which significantly increases their shear strength and deformation capacity. For the upper end of the pillar, the increase in shear strength offered by the confinement is also beneficial against the added shear force from the strut that forms in the buffer wall (Figure 7.4).

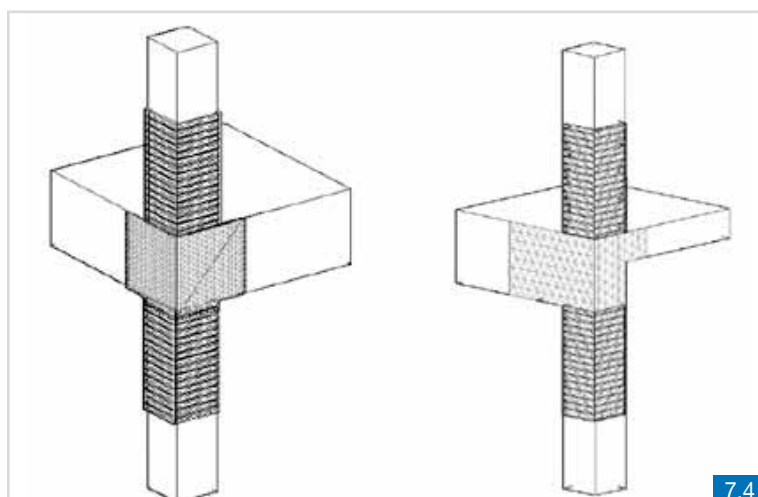
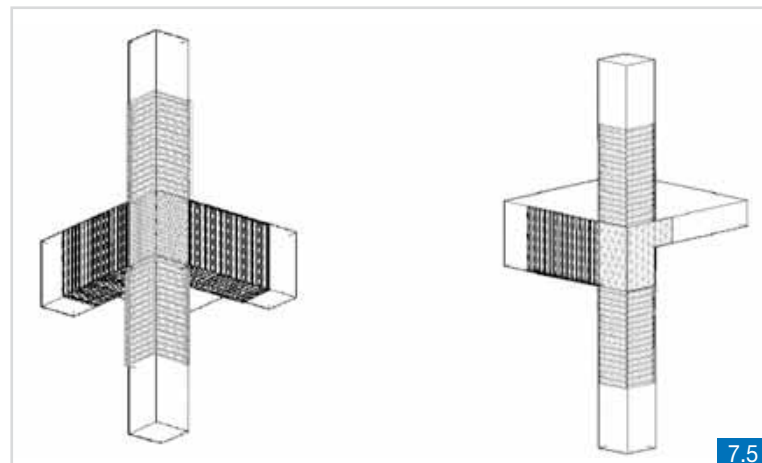

Figure 7.4 - Diagrams from chapter 3 of the ReLuis Guidelines

- 4) The shear strength of the ends of the beams is increased by binding them with uniaxial carbon fibre fabric (MAPEWRAP C UNI-AX) in a “U” formation (Figure 7.5).

Figure 7.5 - Diagrams from chapter 3 of the ReLuis Guidelines



## APPLICATION TECHNIQUE FOR “MAPEWRAP” FABRICS

### Procedure

- 1) Prepare the substrate (as per procedure on page 26).

Prepare all surfaces to be repaired by completely removing all the weak concrete with a hand or power chisel or with other suitable means, such as hydro-scarifying, to obtain a solid, sufficiently rough substrate with no detached portions. If the weak concrete has been removed with a hand or power chisel, clean all exposed reinforcing bars with a brush or by hydro-sandblasting to remove the rust and bring the reinforcing bars back to a bare metal finish. Hydro-sandblasting is not required if the surface has been prepared by hydro-scarifying, but you must wait quite a long time after this operation before treating the reinforcing bars due to on-site logistics constraints. After removing all the rust, treat the reinforcing bars by brush-applying two coats of MAPEFER or MAPEFER 1K one-component, anti-corrosion cementitious mortar. The specific function of both these products, made from cementitious binders, powdered polymers and corrosion inhibitors, is to prevent the formation of rust. Clean all surfaces to be repaired and saturate the substrate leaving a dry surface (s.s.d.) by hydro-cleaning. Reintegrate the concrete using a product from the MAPEGROUT range.

- 2) Carefully smooth all sharp corners to form a rounded edge with a radius of at least 20 mm.

- 3)** Apply a coat of MAPEWRAP PRIMER 1 two-component epoxy primer with a brush or roller to consolidate the surface.
- 4)** Skim the primed surfaces with MAPEWRAP 11/12.
- 5)** Apply strips of uniaxial, high-strength metal fibre fabric (MAPEWRAP S FABRIC) in a criss-cross formation (Figures 7.6 and 7.7).

*Figures 7.6 and 7.7 -  
Shear strengthening of a  
column/beam junction using  
MAPEWRAP S FABRIC*



- 6)** Apply extra corner pieces made from quadriaxial, high-strength carbon fibre fabric (MAPEWRAP C QUADRI-AX) at the intersection between the column and beams.
- 7)** Apply balanced quadriaxial carbon fibre fabric (MAPEWRAP C QUADRI-AX) to the central panel at the hinge point.
- 8)** Confine the top end of the pillar with uniaxial carbon fibre fabric (MAPEWRAP C UNI-AX).
- 9)** Apply open stirrups of uniaxial carbon fibre fabric (MAPEWRAP C UNI-AX) at the ends of the beams in a “U” formation.
- 10)** All the MAPEWRAP C fabric must be sufficiently impregnated with MAPEWRAP 31.

**11**) Dust the resin (MAPEWRAP 31) while it is still wet with dry quartz sand to form a good bonding surface for the successive finishing layer.

*(ref. "Design Guide" procedure G.1.7 and relative technical specifications)\*.*



Figures 7.8, 7.9 and 7.10 - Seismic upgrading of beam-column hinge zones using MAPEWRAP fabrics



### 7.3. Strengthening of masonry arches and vaults

The main aim of installations on arched and vaulted structures is to reduce the loads they impart, so they may be strengthened by plating them using **Mapei FRP System** or **Mapei FRG System** technology. Thanks to the low weight of composites, the use of this type of technology allows strengthening to be applied without increasing the overall mass of the structure.

Asymmetric and dynamic loads, typical of seismic activity, may induce cracking in vaulted structures due to the formation of plastic hinge points. It is widely known that arched structures collapse due to the formation of at least four plastic zone. One possible collapse mechanism may be due to the formation of three hinge points and a double pendulum effect which cause shear slip of one part of the arch with respect to the other. To prevent this type of mechanism, vaults may be protected by applying carbon fibre fabric (MAPEWRAP C UNI-AX, MAPEWRAP C BI-AX or MAPEWRAP C QUADRI-AX), glass fibre fabric (MAPEWRAP G UNI-AX or MAPEWRAP G QUADRI-AX) or basalt fibre fabric (MAPEWRAP B UNI-AX) along the external generatrix of the vaults. FRP strips represent a targeted intervention designed to withstand the tensile forces in the direction of the stresses acting most heavily on each single masonry member (typically flexion, compression/flexion or shear). The inorganic matrix consolidating and strengthening system (Mapei FRG System) is of benefit by distributing the structural capacity of the masonry member so that the improved tensile strength characteristics of the masonry are more or less widespread. Therefore, a global strengthening intervention on vaulted structures is carried out on the internal intrados or extrados by using pre-primed, alkali-resistant (A.R.) glass fibre mesh (MAPEGRID G 220) or pre-primed basalt fibre mesh (MAPEGRID B 250) applied with two-component, high ductility, ready-mixed hydraulic lime (NHL) and Eco-pozzolan based mortar (PLANITOP HDM RESTAURO) or two-component, ready-mixed, high ductility, fibre reinforced cementitious mortar (PLANITOP HDM / PLANITOP HDM MAXI). Thanks to their high synthetic resin content, the latter products offer a high level of adhesion and, once hardened, form a layer which is compact, waterproof, impermeable to the aggressive gases contained in the atmosphere and highly permeable to water vapour. What is more, PLANITOP HDM RESTAURO mortar does not contain cementitious materials and, once hardened, it is highly permeable which allows masonry to transpire naturally.

By using these systems, and thanks to the special weave of the meshes, masonry is stronger and more ductile and stresses are distributed more uniformly. It follows, therefore, that if the structure were to move, the system would have the capacity to distribute the forces over the entire surface of the members, so that the inevitable cracking forms in the construction joints and

in the stone, brick and tuff substrate at the same time. The system adheres perfectly to the substrate, and its mechanical properties are such that localised stresses always provoke a crisis in the substrate rather than at the substrate/strengthening system interface.

Experimental testing, carried out by the Department of Structural Engineering University of Naples “Federico II”, has demonstrated that the strengthening system is highly beneficial in terms of improved shear strength and ductility, and that it distributes stresses more evenly to limit the highly fragile post-peak behaviour of the strengthened member, particularly advantageous in the event of seismic activity.

- Considerable increase in strength (+100%);
- Increase in cracking load (approximately 80% peak load);
- Increase of ductility;
- Not significant increase in stiffness;
- More uniform crack formation due to the excellent compatibility between the composites and the substrate;
- No debonding.

## **APPLICATION PROCEDURE**

### Procedure

#### Substrate preparation

Prepare all surfaces by removing any supports from the extrados or intrados of the vault along with any loose or detached areas to form a substrate that is sound, compact and strong so that the materials and products applied do not detach. Remove all loose material from the surfaces to be repaired with a vacuum cleaner. Open any cracks (both surface cracks and through cracks) and clean with a vacuum cleaner to remove all traces of dust.

Consolidate surface and through cracks by injecting them with lime-based bonding slurry made from a product from the MAPE-ANTIQUE range such as MAPE-ANTIQUE I or MAPE-ANTIQUE F21, or with a cementitious slurry such as STABILCEM.

*(ref. “Design Guide” procedure **H.4.1** and technical specifications **H.4.1.1**, **H.4.1.2** and **H.4.1.3**)\*.*



## Installation of a strengthening package for complete protection of vaults

The first step in applying the system is to smooth over the external surface of the vault with a 5-6 mm thick layer of PLANITOP HDM MAXI two-component, high ductility, pozzolanic-reaction binder based mortar (or PLANITOP HDM RESTAURO) to form a sufficiently flat surface.

Place pre-primed basalt fibre mesh (MAPEGRID B250) or pre-primed, alkali-resistant A.R. glass fibre mesh (MAPEGRID G 220) cut to suit the curved shape of the vault so that it protects the main ribs. Place the mesh so that it follows the form of the vault, hem it over the support areas for the vault and run it down along the existing masonry for 400 mm. Lay the strips of mesh alongside each other and overlap them by around 200 mm. Apply a second layer of PLANITOP HDM MAXI (or PLANITOP HDM RESTAURO) around 5-6 mm thick while the first layer is still wet to completely cover the mesh.

(ref. "Design Guide" procedures **G.2.8** and **G.2.9** and relative technical specifications)\*.

Figures 7.11, 7.12, 7.13, 7.14, 7.15 and 7.16 - Strengthening the outer face of masonry vaults using PLANITOP HDM and MAPEGRID G 220 - Palazzo Sforza, Milan (Italy)



### Installation of a strengthening package to protect the ribs of a vault structure

Another way of strengthening a vault is to protect the ribs with fabrics from the MAPEWRAP range. The first step before applying the fabric is to prepare the substrate with a layer of mortar (PLANITOP HDM / PLANITOP HDM MAXI / PLANITOP HDM RESTAURO) to even out the surfaces on which the fabric is to be placed. Once the mortar has cured, the epoxy cycle is carried out by applying a coat of MAPEWRAP PRIMER 1 (specific epoxy primer for the MAPEWRAP system) with a brush or roller on the surfaces in correspondence with the ribs. Then skim the primed surfaces with MAPEWRAP 11 (two-component, epoxy grout for levelling off surfaces). Apply strips of MAPEWRAP fabric impregnated with MAPEWRAP 31 (two-component, epoxy resin used to impregnate fabrics from the MAPEWRAP line). Massage the impregnated fabric with a special MAPEWRAP ROLLER to eliminate any air bubbles from the mortar-strengthening interface. Dust the resin (MAPEWRAP 31) while it is still wet with dry quartz sand to form a good bonding surface for the successive finishing layer. Once the mortar and resin have cured, replace the supports that were previously removed if required.

(ref. "Design Guide" procedures **G.2.3** and **G.2.10** and relative technical specifications)\*.

Figures 7.17, 7.18, 7.19, 7.20, 7.21, 7.22, 7.23, 7.24 and 7.25 - Protection applied around reinforcement ribs using fabrics from the MAPEWRAP line



## 7.4. Tie area strips

For masonry structures, it is vital to guarantee structural regularity and box-type, monolithic behaviour of the entire structure. Tie area strips make it possible for both adjacent walls (in the case of walls that are not anchored together or in which the anchoring is inefficient) and opposing walls, as well as walls with elements pressing down on them (such as vaults that are not evenly supported or sufficiently balanced by the walls) to interact with each other. In so doing, they provide the most complete solution against horizontal forces (seismic activity), allowing movements and rotation of the walls themselves to reduce their vulnerability to kinematic mechanisms being triggered, such as the walls tilting over due to rotation.

In view of the new technology now available the use of “traditional” tie area strips is not recommended, in that their stiffness and additional weight to the overall seismic mass, incompatible with walls and wooden members, may worsen the behaviour and response of the structure in both the elastic and plastic phases.

Therefore, to prevent tipping mechanisms moving walls out of plane, the trend nowadays is to opt for installations with composite materials when carrying out restoration work on churches or buildings of particular architectural or historical interest, probably due to the fact that the installation is classified as “reversible”, especially by national heritage bodies. The technical and operational feasibility must always be carefully assessed and must always take into consideration the actual state of the building and where it is located. Tie area strips may be created using uniaxial carbon fibre fabric (MAPEWRAP C UNI-AX), glass fibre fabric (MAPEWRAP G UNI-AX) or basalt fibre fabric (MAPEWRAP B UNI-AX). Tie area strips may also be created by applying inorganic matrix composites from the MAPEI FRG SYSTEM.

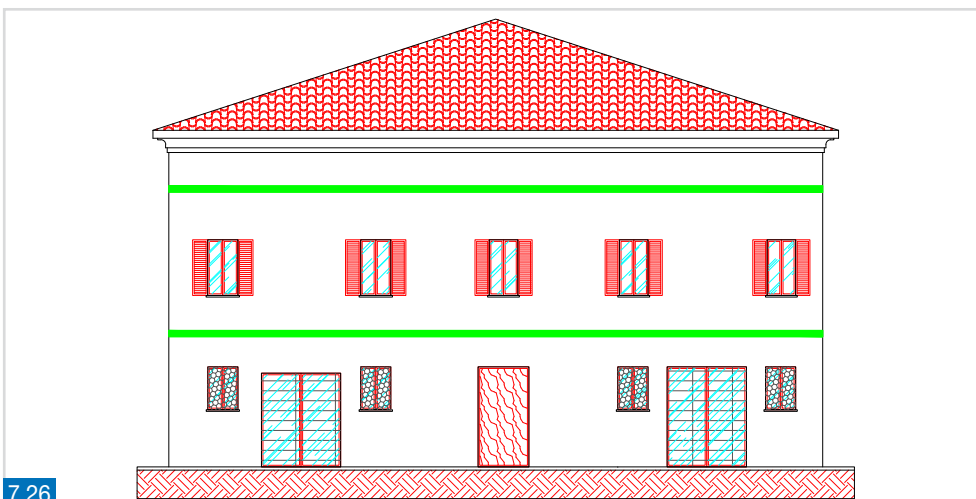

Figure 7.26 - Position of uniaxial fabric strengthening designed to prevent simple tilting mechanisms

## APPLICATION PROCEDURE

### Procedure

In the case of strengthening for lintel bands correct preparation of the substrate is vital, and is carried out by removing any render and any other loose portions to form a substrate that is sound, compact and mechanically strong so that the materials and products applied do not detach. In the areas of the wall where the strengthening is to be applied, a layer of two-component, fibre reinforced, highly ductile, pozzolanic-reaction mortar (PLANITOP HDM / PLANITOP HDM MAXI / PLANITOP HDM RESTAURO) is required to create a sufficiently flat substrate. Once the mortar has cured, apply a coat of two-component, epoxy primer (MAPEWRAP PRIMER 1, specifically formulated for the MAPEWRAP system). While it is still wet, immediately apply two-component epoxy grout for structural bonds (MAPEWRAP 11) and then MAPEWRAP fabric impregnated with medium-viscosity epoxy resin (MAPEWRAP 31, specifically formulated for MAPEWRAP FABRIC). Finally, dust the resin while it is still wet with dry quartz sand to form a good bonding surface for the successive finishing layer.

*(ref. "Design Guide" procedures G.2.3 and G.2.12 and relative technical specifications)\*.*



Figure 7.27 - Application of MAPEWRAP PRIMER 1

Figure 7.28 - Application of MAPEWRAP 11

Figure 7.29 - Application of MAPEWRAP C UNI AX 300 and impregnation of the fabric with MAPEWRAP 31

## 7.5. Anchoring ropes

To protect structural strengthening made using the **Mapei FRP System** and **Mapei FRG System** on concrete, stone, brick and wooden structures damaged by weather and natural causes that require structural and functional restoration, structural connections can be made using MAPEWRAP FIOCCO. MAPEWRAP FIOCCO is a “structural connection” system made from mono-directional carbon fibres (MAPEWRAP C FIOCCO), glass fibres (MAPEWRAP G FIOCCO) and steel fibres (MAPEWRAP S FIOCCO) wrapped in gauze to form cord. MAPEWRAP C and G are then impregnated in situ with MAPEWRAP 21, and are available in various diameters to meet a wide range of site requirements. The “ribbons” are used to make structural connections in general between substrates and strengthening systems. The cord may be used in combination with fabric from the **Mapei FRP System** line, with CARBOPLATE plates and in strengthening systems made using MAPEGRID mesh to help them anchor more strongly, especially when employed for flexural and shear strengthening interventions.

### APPLICATION EXAMPLES

1) Anchoring structural strengthening made using the MAPEGRID mesh strengthening system on vaults and brick, stone and tuff facing walls.

*Figures 7.30 and 7.31 -  
Connections made from  
MAPEWRAP G and C FIOCCO*



**2) Connections between existing perimeter facing walls and pultruded carbon fibre plates (CARBOPLATE) and fabrics from the MAPEWRAP line used for the structural strengthening of beams, floor slabs, etc.**

	MAPEWRAP C FIOCCO	MAPEWRAP G FIOCCO	MAPEWRAP S FIOCCO
Type of fibre:	high-strength carbon	E-type glass	high-strength steel
Density of mix (g/cm <sup>3</sup> )	1.8	2.62	4.84
Tensile strength (N/mm <sup>2</sup> )	4,830	2,560	2,086
Modulus of elasticity (N/mm <sup>2</sup> )	230,000	80,700	210,000
Elongation at failure (%)	2	> 3	2
Equivalent surface area of dry fabric (mm <sup>2</sup> )			
Φ 6	15.70	16.34	–
Φ 8	21.24	21.45	–
Φ 10	26.79	27.58	33.54
Φ 12	31.40	32.69	40.56



MAPEWRAP C FIOCCO



MAPEWRAP G FIOCCO



MAPEWRAP S FIOCCO

### ADVANTAGES

The advantages include a considerable increase in the connection between strengthening applied on structural members and existing substrates and higher durability of materials used for building or repairing civil and industrial structures in aggressive environments where “reinforced connections” need to be applied. MAPEWRAP FIOCCO eliminates any risk of corrosion in the strengthening applied when steel is used.

### APPLICATION

The system is applied as follows:

1. Drill the holes for the MAPEWRAP FIOCCO
2. Prepare the MAPEWRAP FIOCCO
3. Insert the MAPEWRAP FIOCCO

(ref. “Design Guide” procedures **G.1.1** and **G.2.4** and relative technical specifications)\*.

## 1. Drilling the holes for the MAPEWRAP FIOCCO

MAPEWRAP FIOCCO is available in external diameters 6, 8, 10 and 12 mm. The holes drilled in the member must be between 120 and 200 mm in diameter and at least 200 mm deep (the depth of the holes depends on the thickness of the masonry). If the above guidelines are followed correctly, the material injected into the holes will completely embed the MAPEWRAP FIOCCO and provide sufficient anchorage with the substrate. After drilling the hole, remove all dust and loose material with compressed air.



*Drilling the holes*

## 2. Preparation of the MAPEWRAP FIOCCO

Cut pieces of MAPEWRAP FIOCCO at least 400 mm long (the length depends on the thickness of the masonry). Roll back the protective gauze to the same length as the depth of the hole and impregnate this part with MAPEWRAP 21. In order to make the impregnated part of the cord adhere better when it is placed inside the hole, dust it with dry quartz sand to give it a rougher surface. Once hardened, the ropes formed as described above is ready to be applied.



*Impregnating a portion of  
MAPEWRAP FIOCCO*

## 3. Inserting the MAPEWRAP FIOCCO

Apply a coat of MAPEWRAP PRIMER 1 in the holes and then completely fill the holes with epoxy while the primer is still wet. The choice of which product to use must be made according to the type of hole to be filled. For horizontal holes, holes in ceilings or holes in particularly porous substrates, it is better to use MAPEWRAP 11 or MAPEWRAP 12 epoxy resin or MAPEFIX EP epoxy chemical anchor for structural loads, while for holes in floors, holes at a slight angle or holes in compact substrates without internal cracks (e.g. concrete), it is better to use MAPEWRAP 31 medium viscosity epoxy resin. Fill the holes with MAPEWRAP 11 and MAPEWRAP 12 using an empty silicone sealant tube and an extrusion gun, while MAPEWRAP 31 can be simply poured into the holes. After filling the holes insert the pieces of MAPEWRAP FIOCCO prepared previously as above. Splay open the portion of the ropes which have not been inserted into the holes into a fan shape, place them on the part of the structure to be connected and impregnate them with MAPEWRAP 31. A coat of MAPEWRAP 31 must also be applied on the substrate before applying the splayed ropes.



*The ropes are cured for 24 hours*



*The splayed end of a piece of  
MAPEWRAP FIOCCO*

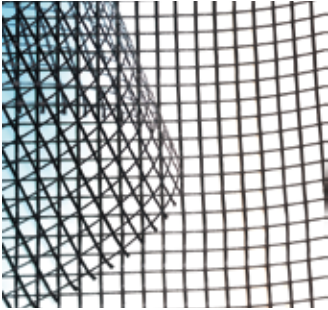

MAPEGRID G 120



MAPEWRAP S FIOCCO



PLANITOP HDM

## 7.6. Seismic upgrading of non load-bearing structures

### D.M. (Ministerial Decree) 14.01.2008 § 7.3.6.3

For construction elements with no particular structural function, measures must be taken to prevent their brittle, premature collapse and the possibility of them being displaced by the action of  $F_a$  (design seismic force, § 7.2.3) corresponding to the SLV (...omissis...).

### Circular No. 617/2009 §C7.3.6.3

The prevention of fragile, premature collapse of buffer walls and the possibility of them being pushed out due to the action of the  $F_a$  (ed. design seismic force) may be achieved by inserting rendering mesh on both sides of the wall and connecting them to each other and to the surrounding structures ... (omissis), that is, by inserting horizontal reinforcement elements in the bed of mortar ... (omissis). The term “non-structural” indicates all those elements that do not have to absorb workloads such as partition walls (dividing walls in internal areas), buffer walls (walls that “close” the building by separating the internal space from the outside), decorative features, plant equipment, etc.

The non-structural parts are represented by buffer walls and partitions. Because of their weight and position, the potential danger of the latter types must never be underestimated when considering the safety of people using a building, including in those cases in which the structure is not particularly badly damaged.

In compliance with national guidelines, to guarantee the connections between the concrete frames and buffer wall panels, anti-overturning interventions are contemplated using inorganic matrix, fibre reinforced materials from the **Mapei FRG System** line.

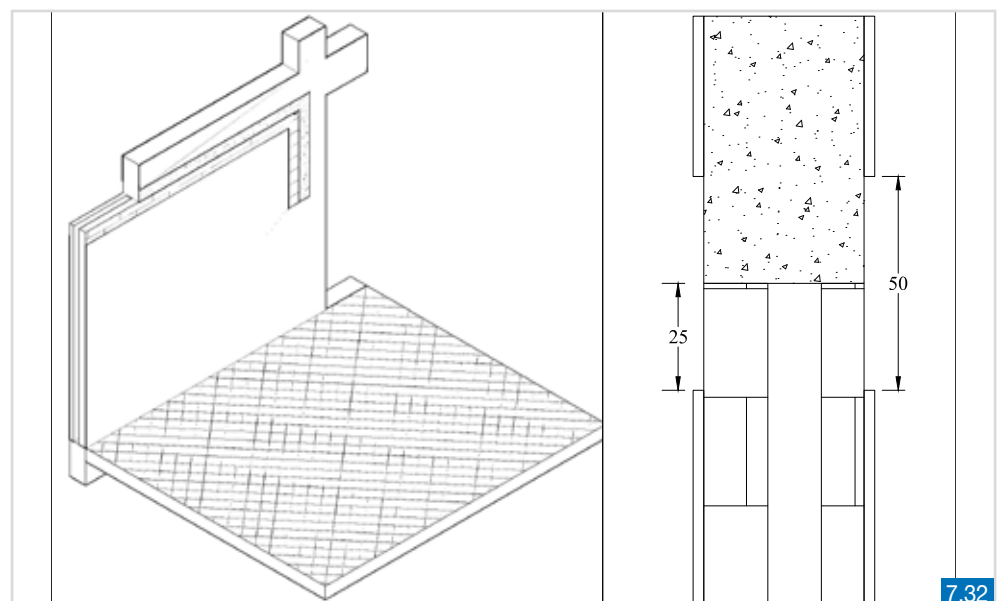

7.32

Figure 22 - Diagrams from chapter 4 of the ReLuis Guidelines



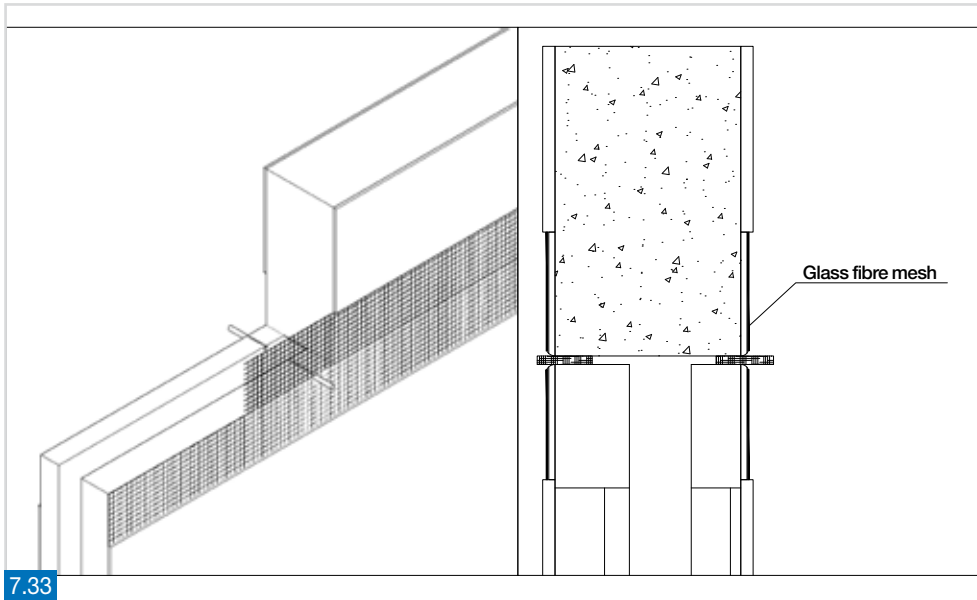

Figure 23 - Diagrams from chapter 4 of the ReLuis Guidelines

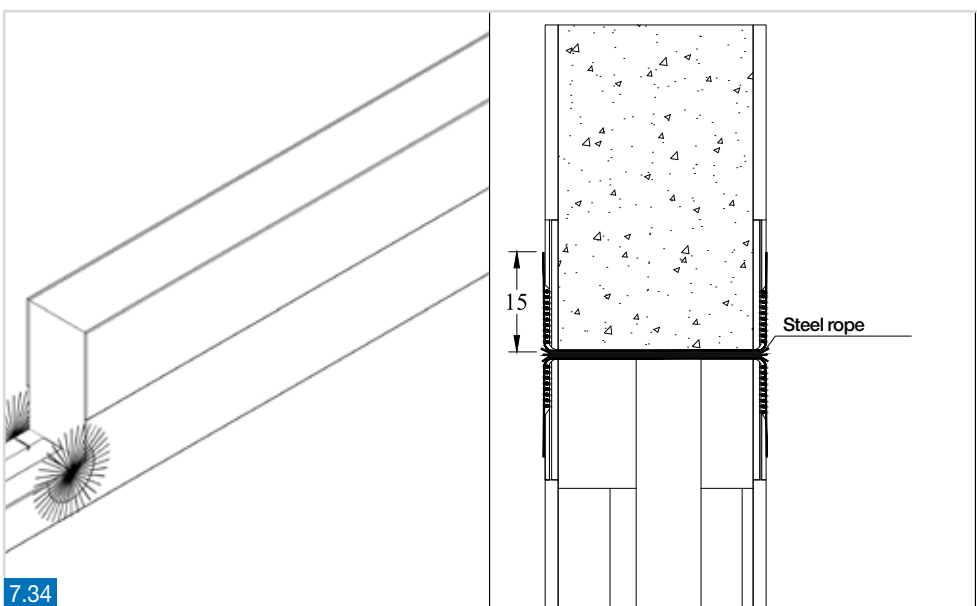

Figure 24 - Diagrams from chapter 4 of the ReLuis Guidelines

### **7.6.1. Anti-overturning system for buffer walls**

In order to prevent walls over turning in the event of seismic activity, the sequence involves creating a reinforcing band of bonding at the interface between the buffer wall and the concrete frame to prevent rotational movements at the base of the wall.

(ref. "ReLuis Guidelines" par. 4.1).

## APPLICATION TECHNIQUE

- 1)** Remove a strip of the existing render along the perimeter anchoring bands around 500 mm wide (250 + 250 mm);
- 2)** drill a hole in the buffer wall and temporarily cover the hole until the cord is inserted;
- 3)** apply a first layer of PLANITOP HDM MAXI and, at the same time, straddle a 450 mm wide strip around the buffer wall of pre-primed, alkali resistant glass fibre mesh (MAPEGRID G 120), used for the localised protection of cracked facing walls, to cover the 500 mm strip of wall from where the render was previously removed;
- 4)** apply a second layer of PLANITOP HDM MAXI so that it completely covers the glass fibre reinforcement mesh;
- 5)** insert the MAPEWRAP S FIOCCO/10 mm high strength, steel fibre cord through the hole in the wall and splay the ends along the two sides of the strengthening using MAPEWRAP 11 epoxy grout for structural bonds.

Figures 7.35, 7.36, 7.37, 7.38, 7.39 and 7.40 - Perimeter connection of a buffer wall

(ref. "Design Guide" procedure **G.3.1** and relative technical specifications)\*.





### **7.6.2. Seismic protection system for non-structural partition walls**

An innovative protection system against seismic activity called **MAPEWRAP EQ SYSTEM** is used in this sector to protect non-structural members. It acts like “seismic wallpaper” and gives people more time to evacuate a building in the event of an earthquake.

One of the most critical features of a building hit by an earthquake is the fact that it becomes very difficult for people to evacuate rooms because of the damage caused to structural and non structural members and elements.



*Figure 7.41 - Damage to a non-structural partition wall caused by the Abruzzo (Italy) earthquake in 2009*

**MAPEWRAP EQ SYSTEM** improves the distribution of stresses induced by dynamic loads on the structure and reduces the vulnerability of secondary partition walls in the event of seismic activity. The system also improves the performance characteristics of concrete and masonry floors and reduces their risk of collapse.



MAPEWRAP EQ ADHESIVE



MAPEWRAP EQ NET

**MAPEWRAP EQ SYSTEM** acts like an “air-bag” for internal and external secondary partition walls (e.g. buffer walls), and stops walls collapsing or tipping out of plane during seismic activity. In so doing, people may evacuate buildings without any particular risk.

**MAPEWRAP EQ SYSTEM** comprises the following:

■ **MAPEWRAP EQ ADHESIVE**

One-component, ready-to-use, polyurethane dispersion-based water adhesive with very low emission of volatile organic compounds (VOC) for impregnating MAPEWRAP EQ NET biaxial, primed glass fibre fabric.

■ **MAPEWRAP EQ NET**

Biaxial, primed, glass fibre fabric to protect secondary partitions in buildings from seismic activity.

The reinforcing system also adheres perfectly to rendered surfaces, as long as they are solid and compact, and increases ductility so that dynamic stresses are distributed more evenly. MAPEWRAP EQ ADHESIVE is formulated so that it is easy and safe to apply both indoors and outdoors without harming the environment.

**7.6.2.1 Laboratory tests carried out on a vibrating test table**

Mapei carried out a series of experimental tests in collaboration with the Karlsruhe Institute of Technology (KIT) in Germany on full-scale buffer panels 2.5 metres wide and 3 metres high fastened securely to a steel frame.

**TEST RESULTS**

Strengthened buffer panels and buffer panels without strengthening were tested on a vibrating table to evaluate how the risk to non load-bearing structures may be reduced in the event of seismic activity, the aim being to prevent collapse and safeguard human life.

Figure 7.42 - Panel without strengthening (left) and a panel strengthened with Mapewrap EQ System (right)



7.42



7.43

Figure 7.43 - Collapse of a partition wall without Mapewrap EQ System

## CONCLUSIONS

- 1) The brickwork panel was stressed at a frequency typically found during seismic activity ( $f_1 = 6.5$  Hz);
- 2) At higher frequencies ( $f_2 = 9.0$  Hz) both flexural and shear damage was found along the wall without strengthening.



7.44



7.45

Figure 7.44 - Flexural failure at the top of a panel

Figure 7.45 - Shear failure at the bottom of a panel

- 3) At these frequencies, the maximum acceleration and deformation occurred at 2.4g. It was also found that the frequency reduced rapidly when structural cracks started to open.
- 4) The frequencies measured on the wall strengthened with MAPEWRAP EQ SYSTEM were decidedly higher, a clear sign that the opening of the cracks occurred later.
- 5) The frequency levels in the sample strengthened with MAPEWRAP EQ SYSTEM were increased to almost the level of resonance and collapse after approximately 3,500 cycles of sinusoidal load, with a response amplitude of 3.5g.
- 6) There was a difference of 80% in the maximum acceleration and deformation due to the bending moment between the “as-built” panel and the panel protected by MAPEWRAP EQ SYSTEM.

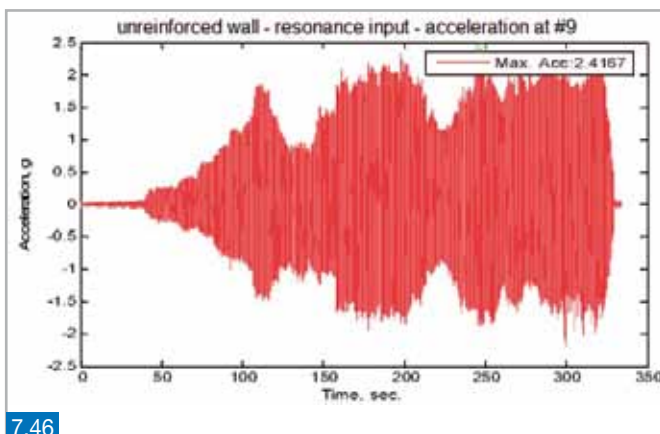

7.46

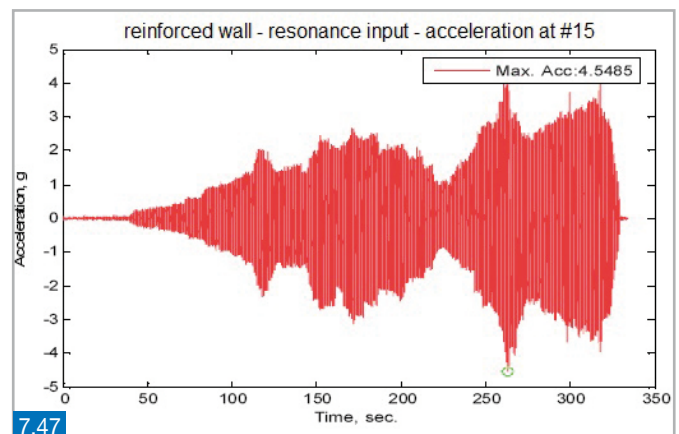

7.47



MAPEWRAP EQ ADHESIVE

MAPEWRAP EQ ADHESIVE	
Consistency:	gel
Colour:	milky white
Storage:	12 months (protect from freezing weather)
Final hardening time:	24 hours
EMICODE:	EC1 Plus - very low emission
Consumption:	0.5-0.6 kg/m <sup>2</sup>
Packaging:	6 kg drums



MAPEWRAP EQ NET

MAPEWRAP EQ NET	
Type of fibre:	primed E-type glass fibre
Weight:	286 g/m <sup>2</sup>
Equivalent thickness of dry fabric:	0.057 mm
Tensile strength:	>1600 N/mm <sup>2</sup>
Tensile modulus of elasticity:	42 GPa
Width:	100 cm
Elongation at failure:	4%
Packaging:	50 m rolls

### APPLICATION TECHNIQUE

Before applying **MAPEWRAP EQ SYSTEM** remove all paint from the substrate. If necessary, prime the area where the system is to be applied with a coat of MAPEWRAP EQ ADHESIVE diluted 1:0.5 with water using a roller to consolidate the surface at the interface between the substrate and the protection system. Then apply MAPEWRAP EQ ADHESIVE with a brush or roller and place MAPEWRAP EQ NET fabric carefully on the adhesive so that there are no creases. To guarantee an efficient, evenly distributed effect from the system, overlap the sheets of fabric lengthways by at least 150 mm and overlap the ends of the sheets by at least 100 mm. After flattening out the fabric, apply a second coat of MAPEWRAP EQ ADHESIVE. When the adhesive is completely dry, apply a skim coat (PLANITOP 200).

(ref. "Design Guide" procedure **G.3.2** and technical specification **G.3.2.1**)\*.

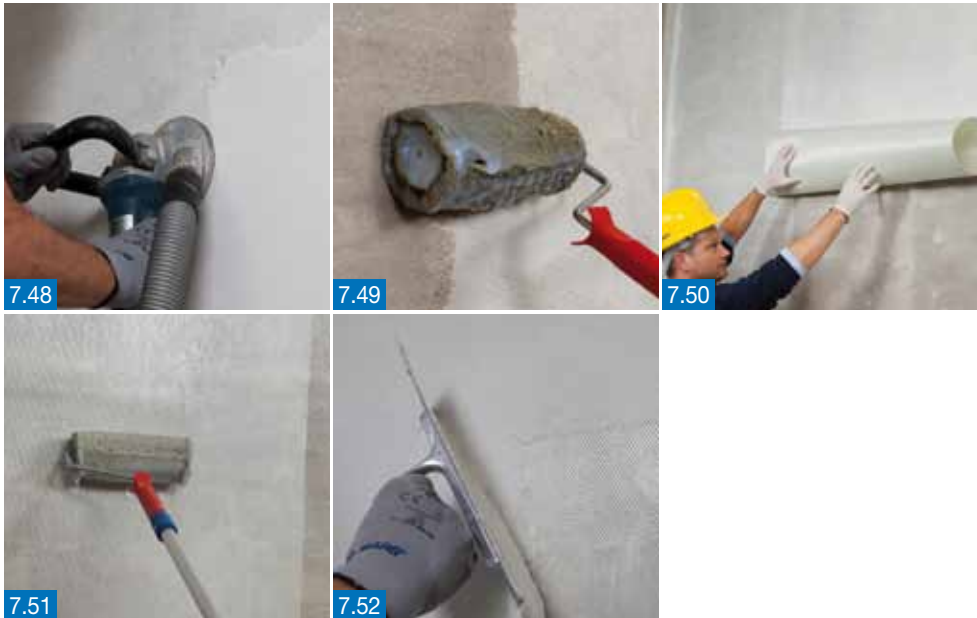

Figures 7.48, 7.49, 7.50, 7.51 and 7.52 - MAPEWRAP EQ SYSTEM

## ADVANTAGES OF THE SYSTEM

The main characteristics of **MAPEWRAP EQ SYSTEM** are:

- Light and compact (< 2 mm);
- May be applied directly over existing render;
- Odourless;
- For indoor and outdoor use;
- Very low emission of volatile organic compounds (VOC);
- Classified EC1 Plus.



**MAPEWRAP EQ SYSTEM** is covered by a worldwide patent and is just one of Mapei's exclusive solutions dedicated to the sector of Structural Engineering.

### **7.7. Installations on damaged or deficient vertical structural members in industrial buildings**

*in compliance with the "Guidelines for localised and global installations on single-storey industrial buildings not designed according to anti-seismic criteria"*

In single storey, prefabricated structures the vertical strengthening elements, or pillars, are normally connected solidly at their base with a pocket footing which forms a socket-type constraint, while the tops of the pillars are connected to the beams with hinged or roller constraints. The force diagram of the pillar, therefore, is that of a cantilever held at the outer face of the pocket.

When there are high stresses, such as those generated by an earthquake, the pillar may move from the vertical plane due to rigid rotation at the foot of the

pillar. This movement is just as likely to be caused by a rotary movement of the entire foundation as by damage to the reinforced cement elements (pockets, plinths, etc.). It is very difficult to ascertain which of the probable causes the damage should be attributed to by means of a simple visual inspection, and usually a much more thorough assessment of the ground and foundations is required along with a more invasive inspection.

It is quite clear that in many pillars there had been an initial formation of a plastic hinge at the base which, in certain cases, had led to the formation of cracks, while in other cases the concrete around the reinforcing bars had been displaced and the reinforcing bars had become unstable where there was a lack of transversal reinforcement.

On-site visual inspections have also led to the discovery that, in numerous cases, the pillars had been damaged by the impact of horizontal members such as beams and tiles that had fallen or collapsed because they no longer had any support. (ref. Guidelines par. 1.3).

Amongst the categories of installations covered by the “**Guidelines for localised and global installations on single-storey industrial buildings not designed according to anti-seismic criteria**”, issued following the earthquake in May 2012 in Italy, there is the strengthening of pillars by binding them with various types of fabric to increase their resistance and ductility. Amongst the weak points highlighted in such structures are insufficient compressive-flexural capacity at the base of the pillars of height  $H$  and insufficient shear capacity. Below are examples of interventions using technology developed by Mapei in compliance with Chapter 4 “**Data sheets for selecting the dimensions, execution and site organisation of interventions**”, which contains guidelines and suggestions that may be adapted to suit typical site conditions and situations.

Figures 7.53 and 7.54 - Damage to industrial buildings caused by the earthquake in Emilia (Italy) in 2012





## 7.7.1. Confinement and strengthening at the base of pillars by forming a sleeve in HPFRC

### (In compliance with data sheet N.ID.RP-4)

Amongst the various installations which may be carried out, one strengthening technique is to form a sleeve around the pillar using high performance fibre reinforced concrete (HPFRC). This type of installation, which involves adding slim sections and slightly modifies the geometry and mass of the pillar, increases its resistance to bending stresses. Confining the critical zone at the base of the pillar, therefore, increases the ductility and load-bearing capacity (axial forces, bending moment and shear) of the main section of the pillar itself.

In compliance with the Italian Guidelines, the strengthening system proposed by Mapei is to form a sleeve around the pillar made from PLANITOP HPC free-flowing, high strength, fibre reinforced, high ductility, shrinkage-compensated cementitious mortar in combination with FIBRE HPC stiff steel fibres for repairing and strengthening concrete. PLANITOP HPC complies with the principles defined in EN 1504-9 (*“Products and systems for protecting and repairing concrete structures: definitions, requirements, quality control and conformity assessment. General principles for the use and application of systems”*), and the minimum requirements of EN 1504-3 (*“structural and non-structural repairs”*) for R4-class structural mortars.

PLANITOP HPC	
Mixing ratio	100 parts of PLANITOP HPC with 6.5 parts of FIBRE HPC (1.624 kg of fibres every 25 kg bag) and 11.5-12.5 parts water (2.9-3.1 litres of water every 25 kg bag)
Bulk density (kg/m <sup>3</sup> )	1400
Application temperature range	from +5°C to +35°C
Compressive strength (EN 12190) (MPa)	> 130 (after 28 days)
Flexural strength (EN 196/1) (MPa)	> 32 (after 28 days)
Tensile strength (BS 6319) (MPa)	8.5 (after 28 days)
Adhesion to concrete (EN 1542) (MPa)	≥ 2 (after 28 days)
Resistance to accelerated carbonation (EN 13295)	meets specifications
Thermal compatibility measured as adhesion according to EN 1542 (MPa) Freeze-thaw cycles with de-icing salts (EN 13687/1)	> 2
Reaction to fire (EN 13501-1)	A1
Consumption (per cm thickness) (kg/m <sup>2</sup> )	approximately 20



Creating a sleeve around a pillar using PLANITOP HPC + PLANITOP HPC FIBRE

## APPLICATION TECHNIQUE

### Procedure

- 1) Before making holes in any of the structural components, use a cover meter to identify the areas without reinforcement.
- 2) Carefully drill holes in the floor to embed the bars that will be connected to the sleeve. An alternative method is to make the connection out of electro-welded reinforcement mesh after creating a seat in the floor to position the mesh.
- 3) Hydro-sandblast or scarify the surface of the pillar to remove any weak concrete and create a sufficiently rough surface to guarantee good adhesion between the base concrete and fibre reinforced mortar without having to resort to the use of epoxy adhesive.
- 4) Apply formwork around the pillar and cast the sleeve by pouring in PLANITOP HPC.

(ref. "Design Guide" procedure **G.1.10** and technical specification **G.1.10.1**)\*.

Figure 55 - Diagram from "Guidelines for localised and global interventions on single-storey industrial buildings not designed according to anti-seismic criteria"

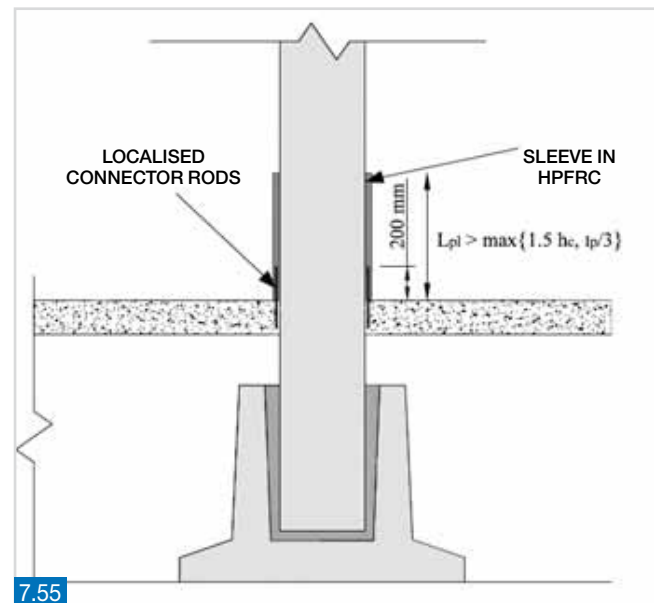

### **7.7.2. Combined bending and axial load strengthening around the base of pillars using fibre reinforced composites with anchoring ropes**

(In compliance with data sheet N.ID.RP-7)

## APPLICATION TECHNIQUE

### Procedure

- 1) Break out a strip of the floor approximately 500 mm wide around the pillar and remove all the material under the pillar down to the upper part of the plinth.

- 2)** Clean the surface of the pillar where the composite materials will be attached and round off the corners of the pillar to form a bending be not less than 25 mm.
- 3)** Drill holes around 20 mm in diameter in the filler mortar between the pillar and the pocket to a depth of around 300 mm.
- 4)** Apply the strengthening system, comprising uniaxial, high-strength, high modulus carbon fibre fabric (MAPEWRAP C UNI-AX), or alternatively pultruded carbon fibre plates (CARBOPLATE) impregnated with epoxy resin or uniaxial steel fibre fabric (MAPEWRAP S FABRIC) on the surface of the pillar up to at least 1/3 of the overall height of the pillar above the pocket. Place the fabrics (or pultruded plates) so that the fibres (or filaments) run parallel with the axis of the pillar. The strips of fabric must be placed so they also run in the gap between the pillar and the pocket for the entire length of the anchoring pocket. The width of the strips of uniaxial composite fabric applied on each side of the pillar depends on how much the compressive/flexural strength needs to be increased.
- 5)** Place uniaxial, high strength steel fibre cord (MAPEWRAP S FIOCCO) in the holes drilled previously and embed them in two-component epoxy resin (MAPEWRAP 11/12) or an epoxy chemical anchor (MAPEFIX EP). Make sure the ends of the cord are splayed open and placed on the surface of the uniaxial composite applied previously (point 4). The steel fibre cord must go right down to the bottom of the hole and run along the side of the pillar for at least 700 mm. MAPEWRAP S FABRIC may also be used to create the ropes.
- 6)** Completely cover the metallic rope with two-component epoxy resin (MAPEWRAP 11/12) to preventing it coming into contact with the carbon fibre fabric to be applied later.
- 7)** Confine the pillar with a series of closed rings of uniaxial, high strength, high modulus carbon fibre fabric (MAPEWRAP C UNI-AX) running continuously up the pillar from the top of the pocket to the upper part of the uniaxial fabric. Place the confinement rings of fabric so that the fibres (or filaments) are perpendicular to the axis of the pillar.
- 8)** Dust the entire surface of the strengthening system with dry, fine quartz sand so that the successive layer of protective finish adheres better.

*(ref. "Design Guide" procedure G.1.9 and relative technical specifications)\*.*

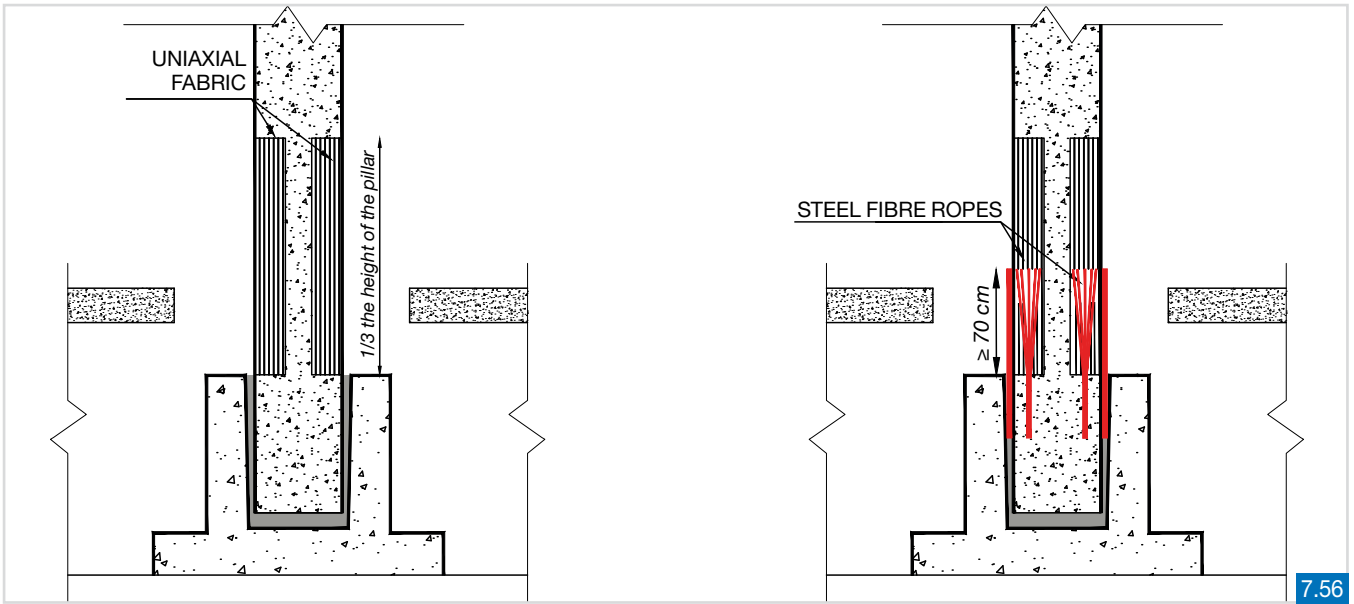

7.56

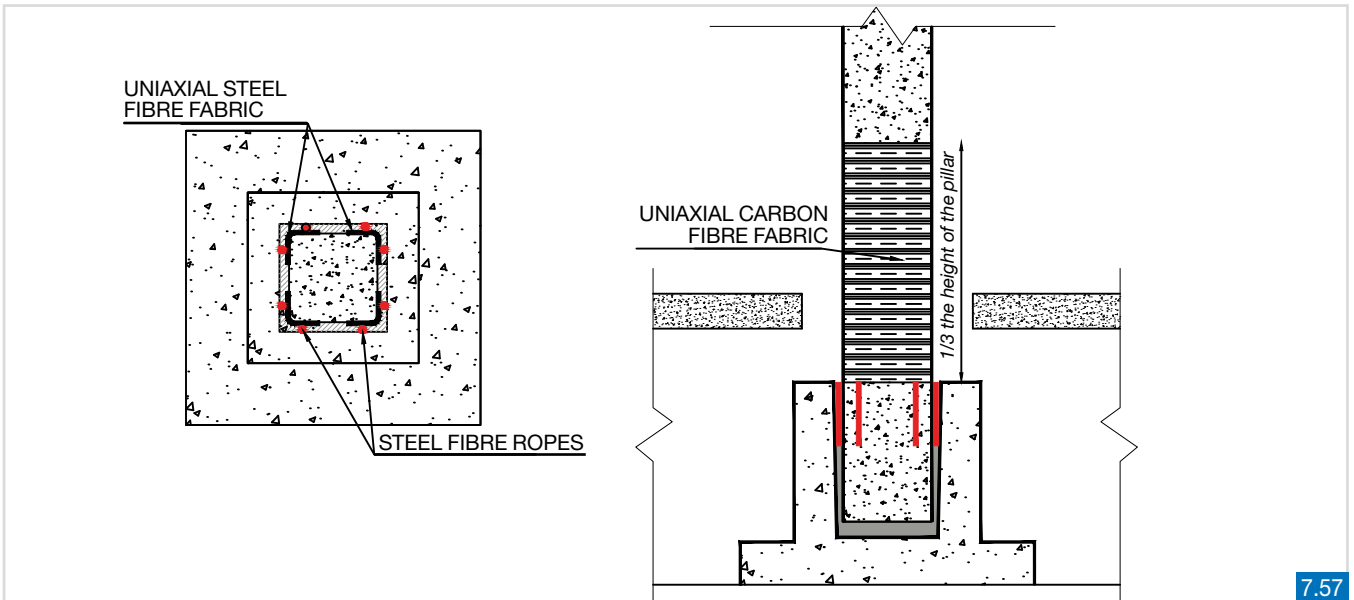

7.57

Figures 7.56 and 7.57 - Diagrams from "Guidelines for localised and global interventions on single-storey industrial buildings not designed according to anti-seismic criteria"

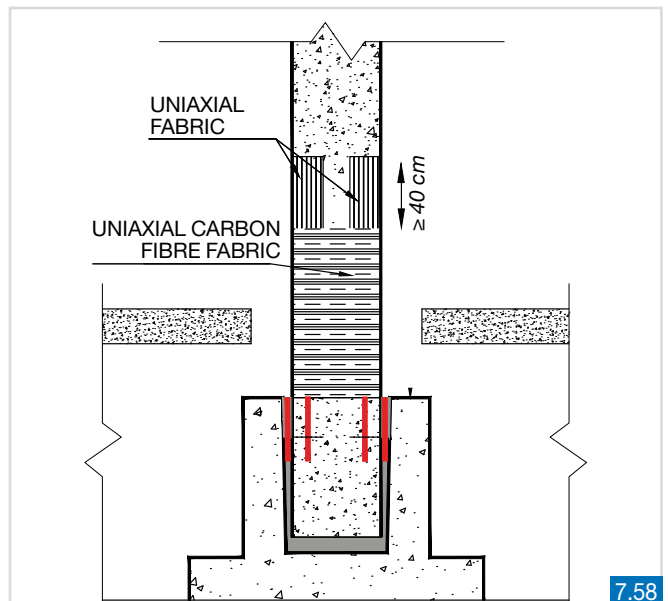

7.58



Figure 7.59 - Drilling holes in the filler mortar in the gap between the pillar and the pocket

Figure 7.60 - Priming the surfaces of the pillar with MAPEWRAP PRIMER 1



Figure 7.61 - Levelling off the surface with MAPEWRAP 11

Figure 7.62 - Compression-flexural strengthening using MAPEWRAP S FABRIC

Figure 7.63 - Applying and embedding MAPEWRAP S FABRIC in the holes

Figure 7.64 - Application of MAPEWRAP 31 impregnating resin

7.65 - Confinement using uniaxial carbon fibre fabric MAPEWRAP C UNI-AX



## 8. *Mapei Technical Services*

Mapei has numerous services available for their clients:

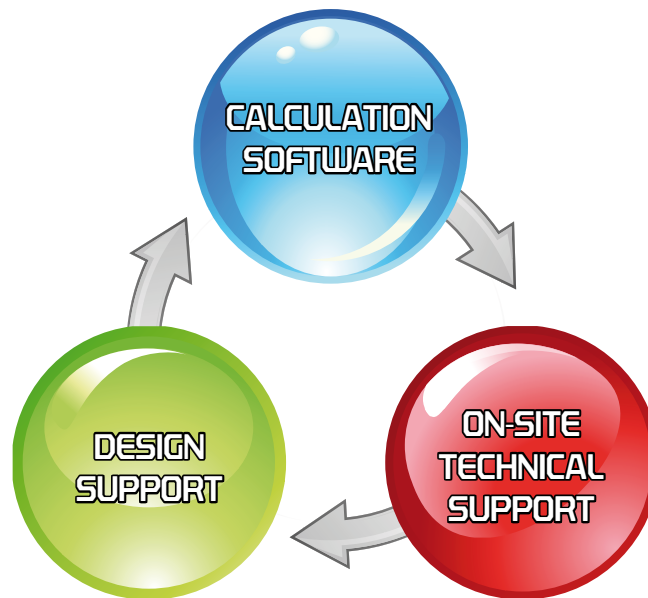

### 8.1. *“Mapei FRP Formula” calculation software*

This software, used to verify reinforced concrete sections, has been developed in collaboration with the laboratory of the Department of Structural Analysis and Design of the “Federico II” University of Naples, and is sub-divided into a series of “Microsoft Excel” spreadsheets.

The formulas used in the calculations are taken from the technical documents CNR DT 200/2004 and NTC 2008 which are currently in force. In order to use these spreadsheets the macro option must be activated (at the top left of each file).

“MAPEI FRP FORMULA” contains the following modules:

- Confinement of rectangular and circular reinforced concrete columns;
- Flexural strengthening of rectangular sections;
- Flexural strengthening of “T” sections;
- Shear strengthening of columns;
- Shear strengthening of beams;
- Stress analysis of reinforced sections in compliance with RARE and QUASI-PERMANENT SLS combinations.

Each module is made up of three steps:

- 1) **INPUT:** input of the geometry of the reinforced concrete sections and the characteristics of the materials;
- 2) **CHARACTERISTICS OF THE STRENGTHENING:** selection of the appropriate strengthening;
- 3) **OUTPUT:** cross-check of the stress on the strengthened section.

The software is available for all technicians and designers by sending a specific request to Mapei Technical Services Structural Strengthening Dpt: [composite@mapei.it](mailto:composite@mapei.it).

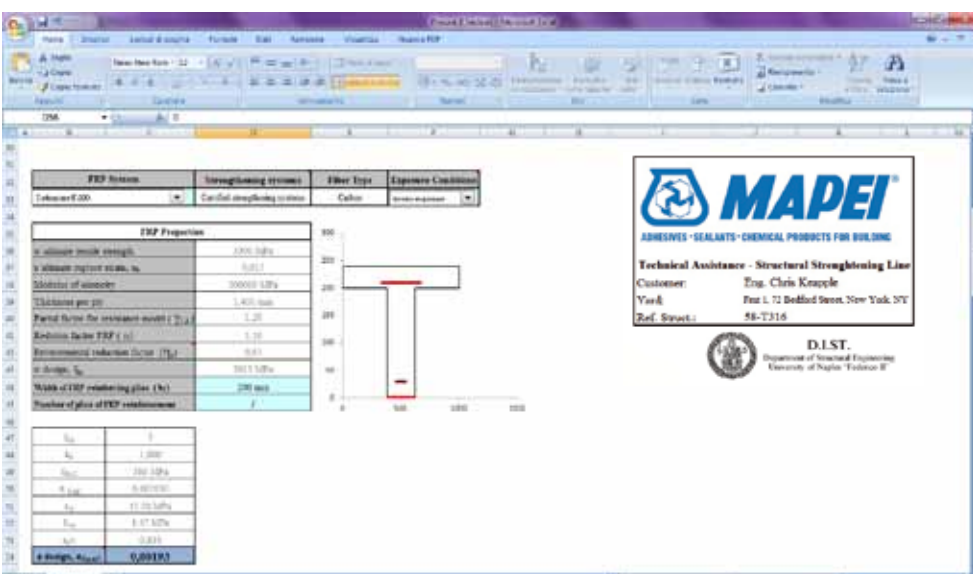
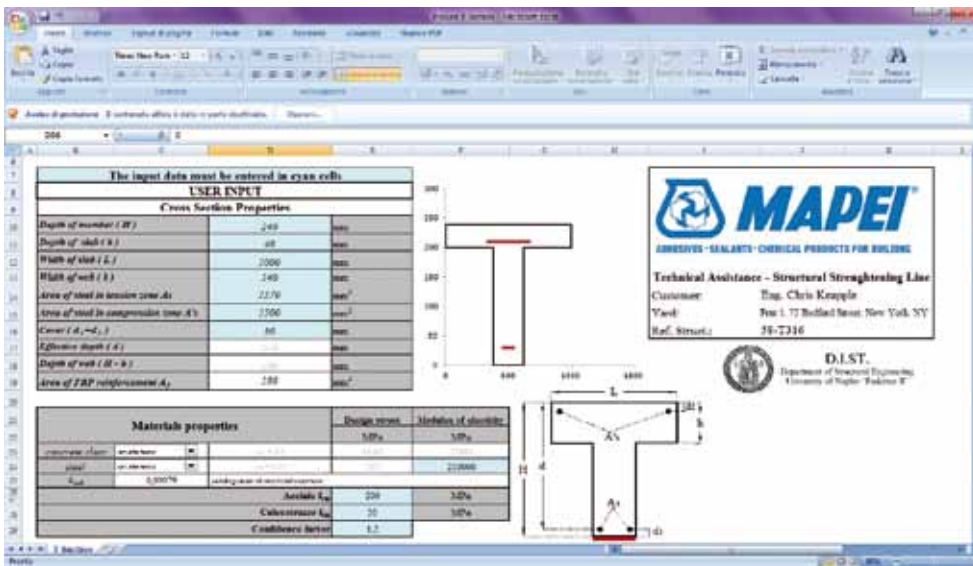

The screenshot shows a software window with a menu bar (File, Edit, View, Format, Tools, Windows, Help) and a toolbar. The main area contains a table with the following data:

OUTPUT STRENGTHENED SECTION									
CALCULATED (TENSILE, STRAIN), NEUTRAL AXIS, DESIGN FLEXURAL STRENGTH OF THE SECTION									
The neutral axis ratio (xi)									
$\xi_c$	Effective depth	$\mu$	$L$	$\mu'$	$\mu_c$	$\mu_s$	Solve	eq. Transverse	$M_d$
(mm)		at	at	50%	10%	50%		(kN m)	
28.13	2	0.89	0.418	-3.97	106.87	187.82		0.00	76.66

UNSTRENGTHENED SECTION			
$\xi_c$	$\mu'$	$\mu_c$	$M_d$
0.00	50%	50%	0.0000
0.0	0.0	0.0	0.0000

## 8.2. On-site technical support

Our strong point is represented by the free technical support available for contractors for:

- site surveys
- commissioning trials and testing

### SITE SURVEYS

Mapei offers a free site survey service which is carried out by local sales engineers, technicians from the Large Projects Division who cover their specific geographical area of interest and the Composite Team together with technicians and engineers from the “Federico II” University of Naples.

Site supervision by one of our experienced technicians during the substrate preparation is also available.

### COMMISSIONING TRIALS AND TESTING

CNR-DT 200/2004 also requires that a series of non-destructive and semi-destructive quality control tests are carried out on strengthening interventions with composite materials to verify the quality of the substrate on which the strengthening system is to be applied and assess how the strengthening system itself has been applied. Mapei Technical Services has this type of service available to carry out, completely free of charge, semi-destructive tests such as the PULL-OFF TEST in compliance with current standards.



The following tests in particular are available:

- pre-strengthening pull-off tests to assess the mechanical performance characteristics of the substrate;
- post-strengthening pull-off tests to verify the quality of the application of the composites.

### **Pull-off test**

The test consists in checking the force required to break a portion of the structure to which a 50x50 mm metal dolly has been applied. The test is carried out using an “Adhesion Tester” with a self-centring mechanism which applies a tensile force perpendicular to the test surface (ref. CNR DT 200/2004 par. 4.8.3.1).

As stated in the technical reference document CNR DT 200/2004 (Guide for the Design and Construction of externally bonded FRP Systems for strengthening existing structures), the results are acceptable if at least 80% of the tests (both tests in case of only two tests) return a pull-off stress not less than 1.2 N/mm<sup>2</sup> and, more importantly, if the failure is localised in the concrete substrate.

The staff is made up of qualified technicians and operates in collaboration with technicians from the DIST (Department of Structural Analysis and Design) of the “Federico II” University of Naples.

*Figure 8.1 - Pull-off test with an Adhesion Tester*

*Figure 8.2 - Cohesive failure of the substrate*



### 8.3. Design support

Mapei's vast experience and qualified technicians are available to contractors and designers with advice and technical support during the design phase. The Mapei "Design Guide" is also available on our website.

The Mapei Design Guide represents a new, key element in the relationship between Mapei and the world of design, a fundamental relationship which will become even more stable thanks to this initiative. The Mapei Design Guide is literally a "technical community", and is just a click away. The Mapei Design Guide currently comprises 17 sections which discuss 17 different design themes, including section G entitled "Application of Composite Materials". It is an interactive manual created in such a way that each user can identify the best solution for a design problem from within an ample range of proposals, based on the experience gained over the years directly on site by the Mapei Group organisation. Knowing that a durable, sustainable installation may only be achieved by thinking in terms of Systems rather than Products has led us to preface each Technical Specification with detailed Procedures which, if followed correctly, will enable you to design and carry out your work to perfection. The rule to construct correctly dictates that a complete, detailed cycle must be supplied, starting from substrate preparation, followed by a description of the various application phases of each different material and its specific function. By following the various procedures, developed and perfected for the most complex, articulated work cycles, it is possible to consult each single Technical Specification and execute a project in its entirety. You can also consult and attach the Technical Data Sheet for each single product, along with drawings of certain operations which are easier to represent through images.

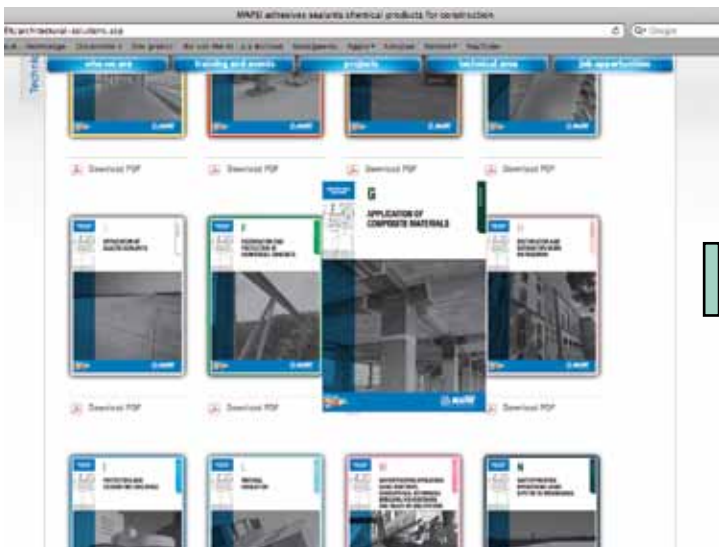





**MAPEI SpA**  
Via Cafiero, 22 - 20158 Milan - Tel. +39-02-37673.1 - Fax +39-02-37673.214  
Internet: [www.mapei.com](http://www.mapei.com) - E-mail: [mapei@mapei.it](mailto:mapei@mapei.it)