

page 04	1. INTRODUCTION
page 05	2. GEOTECHNICS AND FOUNDATIONS
page 05	2.1 GEOTECHNICS
page 06	2.2 FOUNDATIONS
page 11	3. HYDROLOGY AND HYDROGEOLOGY
page 12	3.1 THE WATER-GROUND RELATIONSHIP
page 12	3.2 WATER AND SUBSOIL
page 14	3.3 DRAINAGE SYSTEMS
page 20	4. EXCAVATION WORK
page 24	5. MAPEI WATERPROOFING SYSTEMS FOR FOUNDATION STRUCTURES
page 24	5.1 WHY WATERPROOF?
page 26	5.2 MAPEPROOF AND BENTONITE
page 29	6. SPECIFICATIONS FOR FOUNDATION CONCRETE
page 32	7. WATERPROOFING NEW STRUCTURES BELOW GROUND LEVEL
page 34	7.1 SEALING CONSTRUCTION JOINTS
page 34	7.2 WATERPROOFING THE BASE OF A JIB CRANE
page 35	7.3 WATERPROOFING A LIFT WELL
page 40	7.4 WATERPROOFING HORIZONTAL FOUNDATION PADS
page 42	7.5 WATERPROOFING PILE HEADS
page 47	7.6 WATERPROOFING VERTICAL SURFACES BEFORE CASTING
page 54	7.7 WATERPROOFING VERTICAL SURFACES AFTER CASTING

page	55	7.7.1	WATERPROOFING VERTICAL SURFACES AFTER CASTING WITH MAPEPROOF OR MAPEPROOF LW
page	56	7.7.2	WATERPROOFING VERTICAL SURFACES AFTER CASTING WITH MAPELASTIC FOUNDATION
page	58	7.7.3	WATERPROOFING VERTICAL SURFACES AFTER CASTING WITH PRODUCTS FROM THE PLASTIMUL RANGE
page	61	7.8	WATERPROOFING STRUCTURAL JOINTS
page	64	7.9	SEALING THROUGH-PIPES IN VERTICAL WALLS AND FOUNDATION PADS
page	66	7.10	SEALING A DRAINAGE WELL
page	67	7.11	WATERPROOFING ACCESS RAMPS TO AREAS BELOW GROUND LEVEL
page	69	7.12	WATERPROOFING DEPURATION TANKS
page	71	7.13	WATERPROOFING A SEWAGE WASTE OUTLET AND VENT CAST IN PLACE
page	74	7.14	WATERPROOFING CONSTRUCTIONS BUILT USING THE TOP-DOWN METHOD
page	77	8.	WATERPROOFING EXISTING STRUCTURES BELOW GROUND LEVEL
page	78	8.1	LINING SURFACES IN ROOMS BELOW GROUND LEVEL
page	78	8.1.1	WATERPROOFING VERTICAL SURFACES
page	80	8.1.2	WATERPROOFING HORIZONTAL AND VERTICAL SURFACES WITH MAPEPROOF
page	84	8.1.3	WATERPROOFING HORIZONTAL AND VERTICAL SURFACES WITH A COMBINED BENTONITE-CEMENTITIOUS SYSTEM
page	89	8.2	WATERPROOFING A LIFT WELL AGAINST HYDRAULIC LIFT
page	90	8.2.1	WATERPROOFING WITH OSMOTIC MORTAR
page	91	8.2.2	WATERPROOFING WITH A COMBINED OSMOTIC MORTAR-FLEXIBLE CEMENTITIOUS MORTAR SYSTEM
page	92	8.2.3	WATERPROOFING WITH A COMBINED BENTONITE-FLEXIBLE CEMENTITIOUS MORTAR SYSTEM

1. INTRODUCTION

The issues dealt with in this manual regard waterproofing methods for various types of structures below ground level (Fig. 1.1) according to the type of ground and obviously the effect of water acting upon the structure. A thorough analysis of the morphological characteristics of the ground and water flow during various periods of the year allow for correct analysis of the construction technique applied for structures below ground level. Studying the characteristics of the ground (geotechnics) supplies useful information about the load-bearing capacity of the ground itself and its hydrogeological conformation. It is also important that any water present below ground level is carefully studied (hydrology) in order to assess the context in which new structures are built, such as water under pressure, water percolating from below or the presence of widespread damp. This will then influence the type of foundations system chosen for the structure, the type of waterproofing used and, clearly, the type of temporary supports required to construct the final structure.



Fig. 1.1 – Phases of an excavation for construction work carried out below ground level in a built-up area

2. GEOTECHNICS AND FOUNDATIONS

2.1 GEOTECHNICS

Geotechnics is the study of the mechanical aspects of the ground and its application in engineering works. The stratigraphic conformation of the ground and its mechanical behaviour is analysed to identify the most suitable type of foundations to guarantee the stability and durability of a structure.

Foundations are structural elements with the function of transferring stresses and loads, both permanent and accidental, from the structure constructed on the foundations to the ground. The type of foundations determines the “footprint” that a structure leaves on the ground. The size of the footprint (plinths, ground beams, foundation pads and ribbed foundation pads) is inversely proportional to the resistance of the ground and proportional to the loads to be discharged onto it. The ground, foundations and the overall structure, therefore, form a single unit body which must be considered as a single system.

The design of a structure starts with a preliminary analysis to determine the type, stratigraphic conformation and physical and mechanical characteristics of the ground. It is particularly important to determine the safety load of the ground, known as its “load-bearing capacity”, expressed in kg/cm^2 .

Apart from the economic aspects to be taken into consideration, there are a number of other parameters which also contribute in defining the type of foundations to use, with the main ones being as follows:

- the construction system adopted for the structure built on the foundations;
- restraints and guidelines of local building regulations;
- the depth at which the layer with sufficient load-bearing capacity on which the loads act is located.

WATERPROOFING STRUCTURES INSTALLED BELOW GROUND LEVEL

2.2 FOUNDATIONS

Foundations form a group of structural elements within a construction system, with the function of transmitting loads to the ground. Since the behaviour of the ground, the foundations and the structure built on the foundations are dependent on each other, there is a wide array of variables which have to be considered when calculating the size of foundations. The parameters below must be taken into consideration when choosing the type of foundations:

- the loads acting upon the foundations;
- the final use of the building;
- type and stratographic conformation of the ground;
- the presence and level of the stratum;
- the height of the foundations;
- economic implications;
- presence and type of surrounding buildings;
- friction and slope of the ground on which the foundations are installed.

The forces transmitted from the structure to the foundations are the sum of the following:

- loads from the structure;
- permanent overloads;
- accidental overloads (according to the final use of the structure);
- horizontal forces due to winds (generally bending moments);
- horizontal seismic loads (applied either dynamically or statically to the calculation model).

Foundations may be sub-divided according to their load transfer mechanism to the ground or according to the Terzaghi classification system. In the first case, the foundations may be classified as illustrated in Fig. 2.1.

With direct (or surface) foundations, the forces are transferred to the ground by enlarging the load-bearing elements of the structure on the

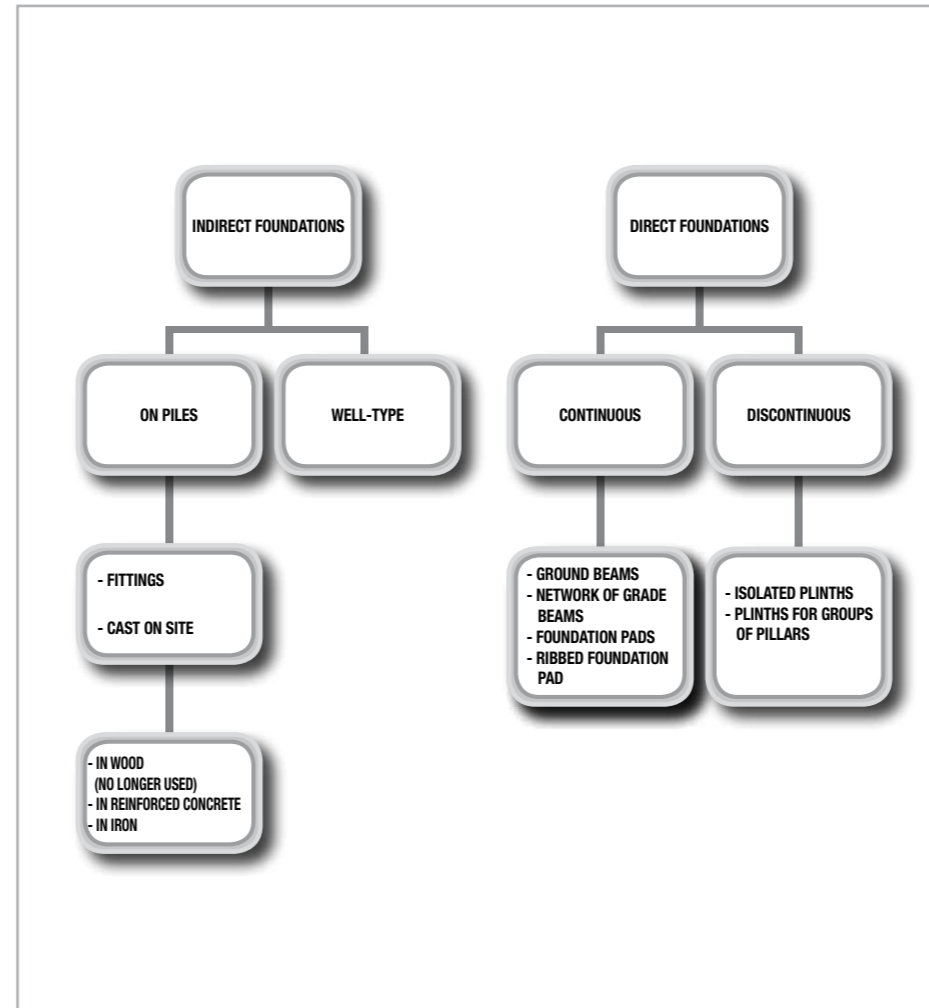

Fig. 2.1 – Classification of foundations according to their load transfer mechanism to the ground

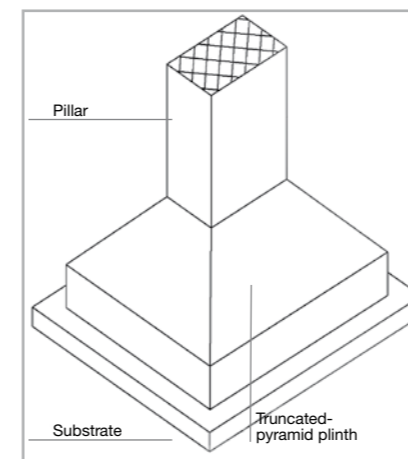

Fig. 2.2 - Truncated-pyramid plinth

foundations, while with indirect (or deep) foundations, the forces are transferred mainly by friction or lateral adhesion at the pile-ground interface. The most simple form of intermittent direct foundations are represented by plinths, which basically consist of enlarging the pillars to distribute the loads over a larger surface area. In certain cases, because of the poor mechanical characteristics of the ground, restraints by seismic regulations or if the loads have to be distributed over larger areas and the plinths are too large, foundation pads which cover the entire area of the building (continuous direct foundations) are a more feasible solution. In other cases, indirect foundations such as piles have to be used, so that the loads from the structure on the foundations are transferred to more compact and resistant ground which may only be found deeper down. If the Terzaghi classification is followed, on the other hand, the various types of foundations may be sub-divided according to the ratio D/B (D: depth of the foundations, B: width of the foundation base):

- direct or surface foundations (plinths, continuous beams, foundation pads) $D/B < 4$;
- semi-deep foundations (shafts) $4 < D/B < 10$;
- deep foundations (piles) $D/B > 10$.

Direct (or surface) foundations may be used when it is not necessary to excavate deep down to reach ground with good mechanical characteristics. According to the form and size of the support base, these structures may then be sub-divided as follows:

- intermittent (or isolated) foundations such as plinths;
- continuous foundations such as ground beams and foundation pads.

Plinths (Fig. 2.2) are used to build framed structures (in reinforced concrete or steel) for low stresses on ground with good geotechnical characteristics. They are generally quite precise elements with a truncated pyramid shape and a square base, and form an enlargement at the base

WATERPROOFING STRUCTURES INSTALLED BELOW GROUND LEVEL

of the pillars. If they are not too tall, they are without a doubt the most economical type of foundation. Plinths are mainly subjected to vertical forces, so the size of their surface is given by the vertical loads and load-bearing capacity of the ground, while their height is determined by the capacity of the material to resist shear loads. If the plinths are rectangular, the longer side of the plinth is parallel to the longer side of the pillar. Plinths may be defined as being either squat or slim according to their height to longer side ratio. According to parameters contained in building regulations for seismic zones, the plinths must be connected to a beam and curb network to guarantee that the behaviour of the entire structure is more homogenous.

Continuous direct foundations, on the other hand, are formed by continuous elements such as ground beams or foundation pads and are usually used in the following cases:

- when the resistant ground does not have a very high safety load (load-bearing capacity);
- when the resistant ground is at a shallow depth compared with ground level;
- when the resistant ground is at such a depth that it is more economical to reach it using deep foundations;
- when particularly high loads act upon the foundations.

Ground beams (Fig. 2.3) are structural elements which function mainly in a longitudinal direction and, unlike in the case of static overhead beams, the vertical loads acting upon them are generated by their reaction with the ground and act in an upwards direction. Ground beams are used when a large support surface is required to transmit the loads to the ground, or if the ground has particularly irregular point to point resistance (therefore

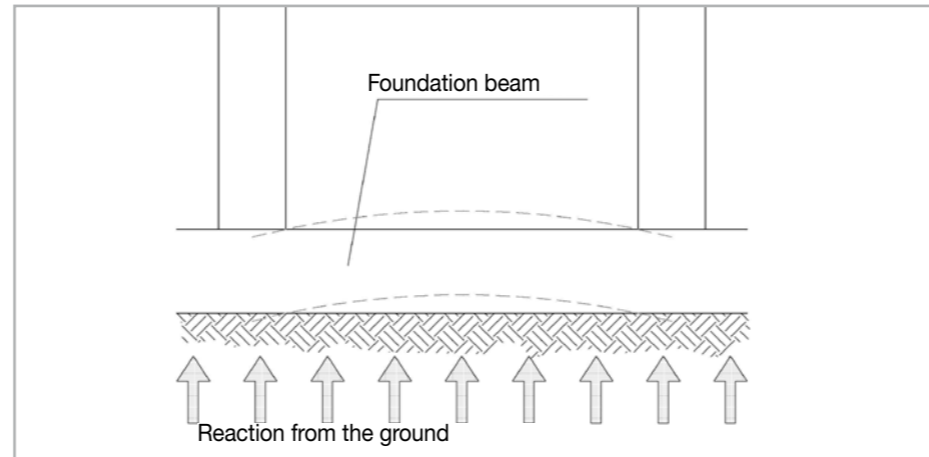

Fig. 2.3 – Schematic diagram of stresses acting on a foundation beam

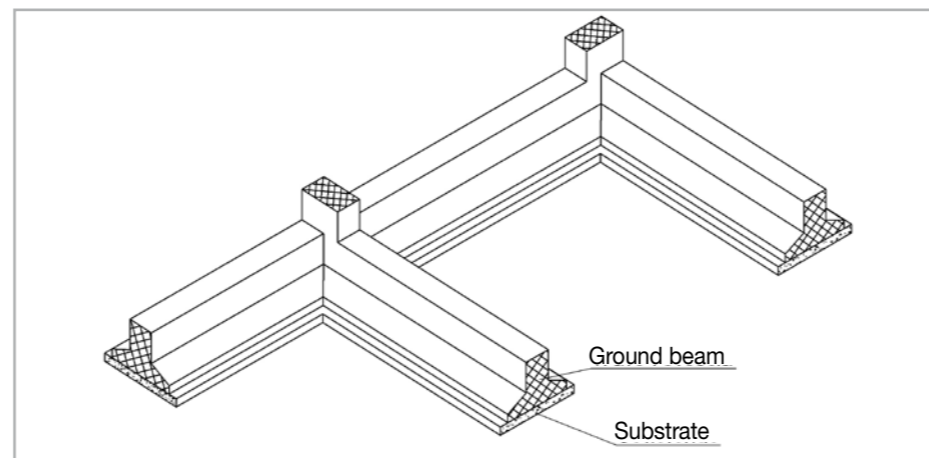

Fig. 2.4 – Lattice of a ground beam

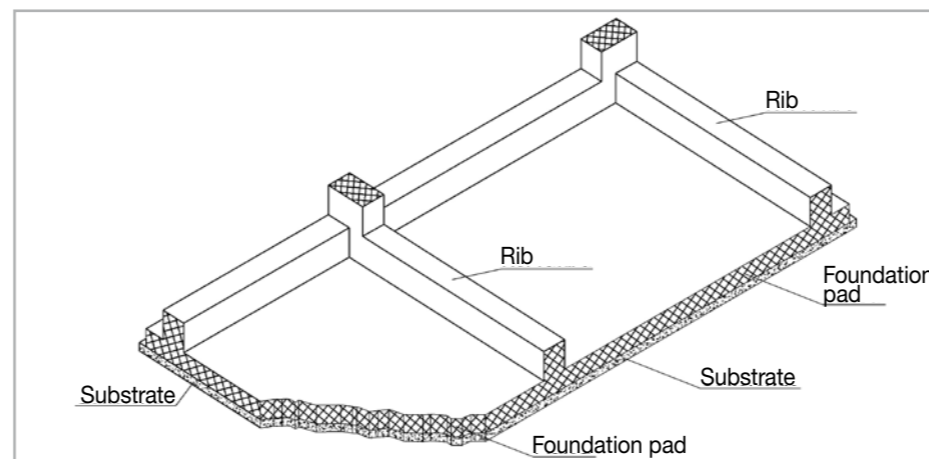

Fig. 2.5 – Ribbed foundation pad

with the risk of differential settling). In the case of networks of ground beams (Fig. 2.4), the beams themselves are placed at right angles and intersect in correspondence with the pillars.

Foundation pads are used when very high loads need to be transferred into ground with poor load-bearing capacity, or when it is not possible to install deep foundations. This technique may be considered a development of ground beams and is formed by a reinforced concrete floor slab which covers the entire area of the ground where the building is constructed and in which the pillars are inserted.

A foundation pad is a slab subjected to vertical forces concentrated in correspondence with the pillars, bending moments at the pillar/foundation joints and loads distributed uniformly over the entire surface generated by the reaction of the ground in the opposite direction to the vertical loads from the pillars. There are two types of foundation pads:

- ribbed type formed by a single lower pad and a network of main and secondary beams (Fig. 2.5);
- full type.

Which type to use depends on economical factors, such as lower costs for materials and labour, and technical considerations, in that ribbed foundation pads are stiffer and weigh less compared with the full type with the same thickness.

Semi-deep foundations are shaft type, used in the 19th Century and nowadays completely abandoned. This technique consisted of digging a deep well or shaft with a defined shape down to a layer of resistant ground. It was then filled with dry, well-packed material or a cementitious conglomerate with a low cement content, to form masonry pylons on which the construction was built formed by connecting beams and arches to discharge the loads.

Deep foundations are used when, because of the poor mechanical

WATERPROOFING STRUCTURES INSTALLED BELOW GROUND LEVEL

characteristics of the surface of the ground, more resistant layers with suitable load-bearing capacity to withstand the loads from the structure deep down in the ground need to be reached. Deep foundations are formed by foundation piles with a round profile. The load-bearing capacity of piles (Fig. 2.6) is given by two distinct characteristics:

- vertical load-bearing capacity;
- lateral load-bearing capacity.

The first characteristic depends on the section of the pile and the layer reached by its base (which is why we try to reach the most resistant layers with the base of the pile). The second characteristic, on the other hand, is due to friction between the side of the pile and the ground around the pile and depends, therefore, on the type of pile and the type of ground. Very often, friction is the predominant phenomenon for the load-bearing capacity of piles. In fact, there is a particular category of piles, the suspended type, in which the base of the pile does not reach the more resistant layers of the ground and its entire load-bearing capacity is given by friction along its sides.

According to the installation technique used, piles are sub-divided as follows:

- bored piles (Fig. 2.7): the first step is to remove the soil and then cast a cementitious conglomerate in place which is usually reinforced. The bored hole may be formed by perforation (using rotating or rotor-percussion equipment) or by excavating (using a digger fitted with a round toothed bucket). When forming the hole, the side walls may be made more stable by using a stabilising fluid or by installing a temporary metallic liner (called a sleeve). Once the hole has been completed, the steel reinforcement cage is inserted and the concrete is poured in through a tube. Once the casting operation has been completed, the temporary metallic liner may be removed.

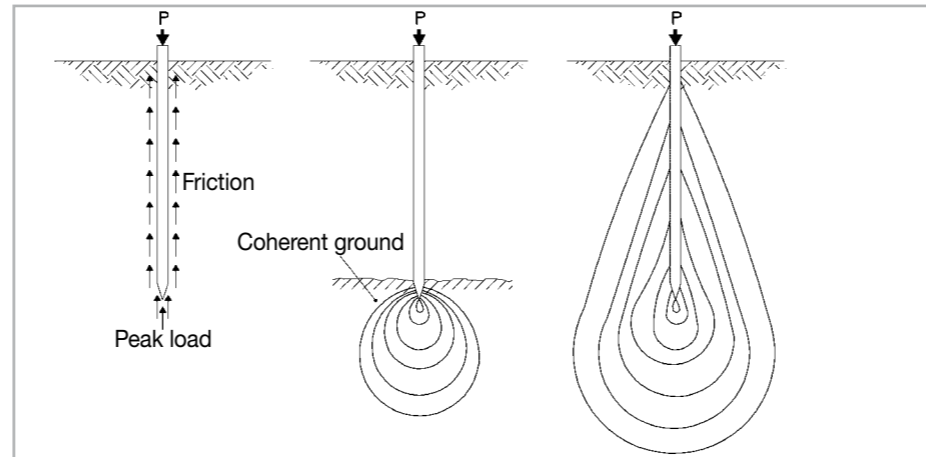

Fig. 2.6 – Schematic diagram of strains acting on a foundation pile

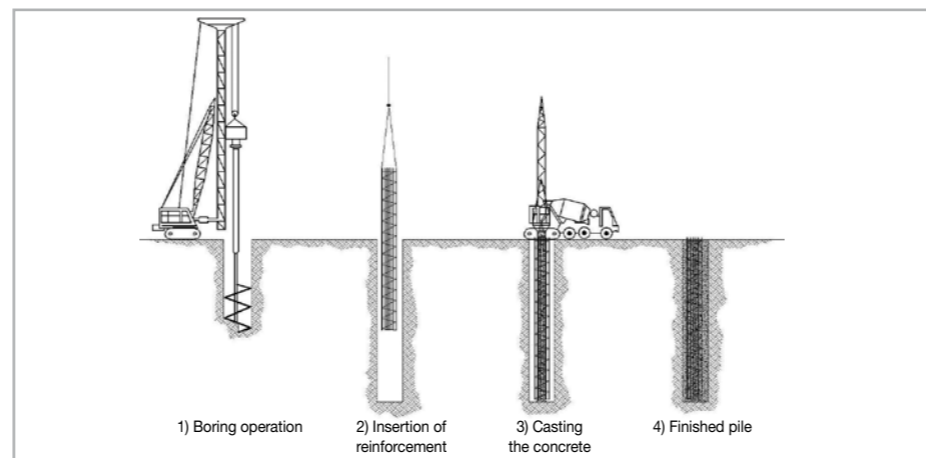

Fig. 2.7 – Phases of the construction of bored piles

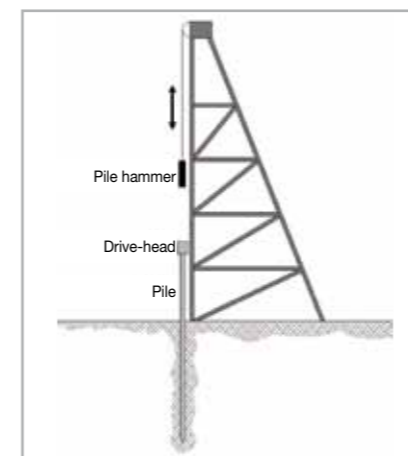

Fig. 2.8 – Schematic diagram of a pile being rammed into the ground

- driven piles (Fig. 2.8): the soil is not removed and the piles are driven into the ground by hammering, vibrating, pressing, screwing or by a combination of these techniques. Driven piles generate a lateral compacting action upon the ground which increases their lateral resistance due to friction. A negative aspect of this technique is that the piles may be quite long and a high amount of energy is required to ram them in. Rammed piles may be made using the following materials: steel, reinforced concrete, wood (although this material is no longer used) or a combination of materials.

Piles usually have a circular section and their diameter varies according to their structural requirements; smaller diameters, between 100 and 200 mm, are known as micro-piles. The transfer of loads from the built structure to each single pile, which are levelled off to the same height after installation, is through connecting structures on the surface such as plinths, ground beams and foundation pads. When analysing and considering the nature of the ground for the foundations, its water content, one of the most important factors of the ground, must be carefully assessed. This is why it is useful to briefly discuss hydrological and hydrogeological aspects, the latter of which is the study of underground water and its properties.



3. HYDROLOGY AND HYDROGEOLOGY

Hydrology is the science which studies water on the earth, both on the surface and below the surface, how it is formed, how it circulates and how it is distributed with respect to time and space, its biological, physical and chemical properties and how it interacts with the environment, including with living beings. In brief, hydrology is the study of the flow of water which forms the so-called hydrological cycle. Hydrogeology is the branch of geology which studies phreatic or underground water and its properties.

WATERPROOFING STRUCTURES INSTALLED BELOW GROUND LEVEL

3.1 THE WATER-GROUND RELATIONSHIP

The ground is made up of various types of solid material of various origin and empty spaces (Fig. 3.1) in various shapes and sizes. The quantity of empty spaces varies, and they may contain either air or water which enters and then circulates.

3.2 WATER AND SUBSOIL

The capacity of the ground to let water pass through is called **permeability** and depends on the presence of voids in the solid material which forms the ground itself. If the voids are formed by pores, it is called permeability by porosity. If the voids are formed by fractures, on the other hand, it is called permeability by fracturation. In both cases, only the voids which are connected to each other allow water to move.

An example of a very porous rock with low permeability is pumice, in which only a few of the pores in the rock are connected together. Ground formed by large-grained pieces is highly permeable. This means that water infiltrates easily and does not tend to remain on the surface. In ground formed by small-grained pieces, such as clayey ground, the water filters through much more slowly. Therefore, where clayey ground is found, it is more likely that water will be found on the surface. In ground formed by layers of compact rock, permeability varies according to the number and size of the fractures and how these fractures are connected together. Therefore, to sum up, water passes through both layers of clay (soil) and layers of gravel (rock), but the intensity of the phenomenon is completely different. More than a century ago, Darcy studied the flow of water through horizontal sand beds, and established that the flow speed through porous matter is directly proportional to the loss in load and inversely proportional to the length of the route. Darcy bound the various rates with the following well-known equation:

$$v = k i$$

where v is the discharge speed, k is the coefficient of permeability or coefficient of hydraulic conductivity, and i is the hydraulic gradient

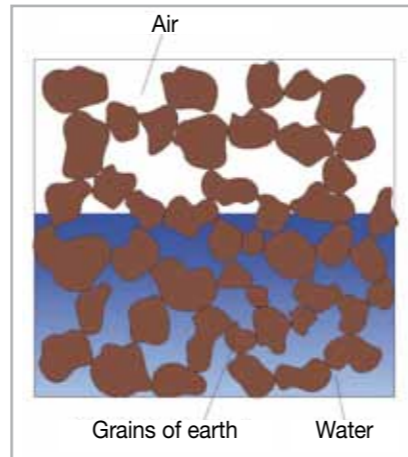

Fig. 3.1 - Schematic sectional view of a portion of ground

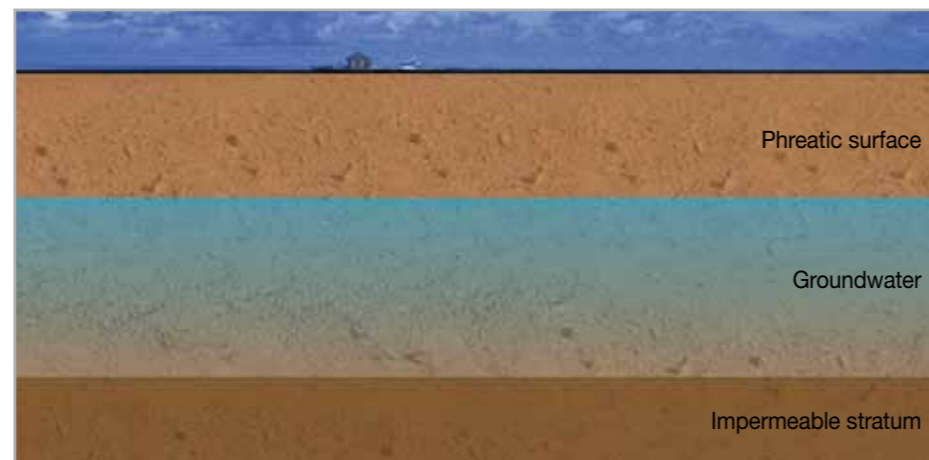

Fig. 3.2 - Sectional view of a portion of ground and its water table



Fig. 3.3 - Sectional view of a portion of ground and an artesian stratum

or slope of the piezometric line. Between 1915 and 1925 Terzaghi demonstrated how Darcy's law could be applied to all types of ground. The coefficient of permeability k expresses velocity and depends on the porosity of the material and the fluid. Various factors have an influence on the coefficient, especially k which is directly proportional to the size of the granules. In fact, gravelly ground has a high rate of permeability, whereas clayey ground is more or less impermeable. **In the following section, the term "impermeable" will be used a number of times, while in nature completely impermeable ground does not actually exist.**

Water which infiltrates into the ground and moves in the subsoil forms underground "groundwater". The term "aquifer" will be used in this section, which indicates ground (compact or less compact, and either stratified or non-stratified) which has the capacity of storing water, making it circulate and then returning it in large quantities. An aquifer is delimited in the lower part by a layer of impermeable ground and the water moves around slowly in the aquifer.

In general, aquifers fed directly by rainwater which infiltrates from the surface and penetrates into permeable ground, until it runs into an impermeable layer of material (for example clay) which slows it down (or which completely blocks it) and stops it going deeper, are known as water tables or free strata. This layer forms the base or "bed" of the water table. The upper limit of the water table is basically formed by a finer saturated zone (the "phreatic surface") and the pressure of the water contained in it is the same as the atmospheric pressure.

There are also strata under pressure known as artesian strata (Fig. 3.3) which are delimited in both the lower and upper parts by an impermeable layer. The water which feeds these strata is the same which infiltrates where the permeable ground, which forms the stratum itself, is on the surface and may therefore receive the water. Thus, the area which feeds a stratum under pressure may be quite a distance from the stratum itself. Strata "under pressure" are known by this term because the water inside the stratum is subjected to a pressure which is higher than the

WATERPROOFING STRUCTURES INSTALLED BELOW GROUND LEVEL

atmospheric pressure, and which helps it rise spontaneously inside a hole drilled in the ground. The water contained in both types of aquifer may be extracted by making a well.

The water contained in the ground may be classified differently according to the way it bonds with the grains of earth:

- retained water which adheres to the grains of earth and is not part of the hydrologic cycle;
- free water which infiltrates into the ground due to the force of gravity.

Free water is the most important type regarding the problem of ground drainage.

Underground water may be conducted to two different zones: saturated and non-saturated. The non-saturated zone may be found immediately below the surface of the ground and the empty spaces contain both water and air, while the saturated zone forms the actual stratum.

3.3 DRAINAGE SYSTEMS

If there is an area of a site with groundwater, a suitable drainage system must be installed in order to carry out construction operations. The type of drainage system used is highly dependent on a thorough understanding of the lithologic nature of the area of ground in question and the need to lower the level of the groundwater.

Draining off the groundwater using a wellpoint system allows construction work to be carried out, even when there is water present. The relatively low cost of this system compared with the results obtained is the main advantage of this solution, and it is the quickest and most cost-effective method to temporarily or permanently drain off groundwater. The wellpoint system, which has been used for a number of years in industrial and construction applications, has been developed over the last few years and is now often used for reclaiming land.

The wellpoint system (Fig. 3.4) is just one of the techniques applied, and



Fig. 3.4 – Flexible hoses used to connect wellpoints to an intake manifold

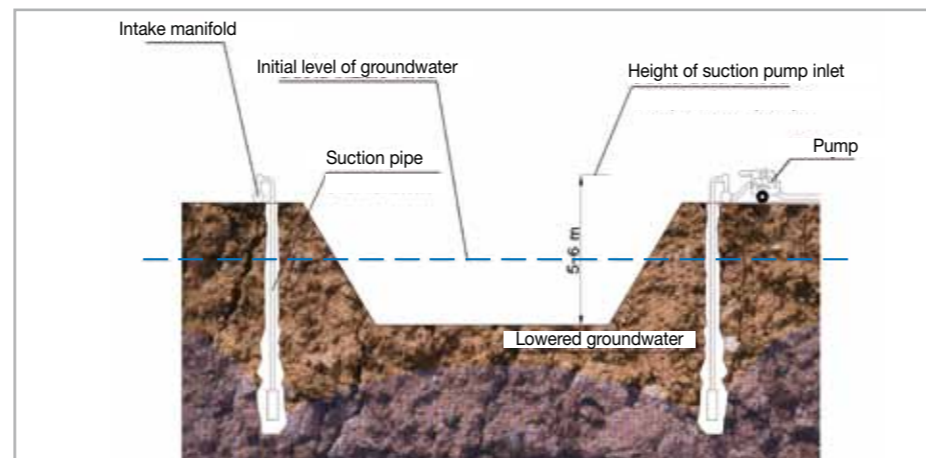

Fig. 3.5 – Schematic diagram of how the level of the water table is lowered using a wellpoint system



Fig. 3.6 – Drilling operations to insert wellpoints

consists in forming a number of mini wells (wellpoints) in the area around the ground where the level of groundwater needs to be lowered, and is mainly used in sandy ground. It is also used to dry off muddy ground after forming drainage sleeves in which the wellpoints are positioned. It is important to point out that a wellpoint system temporarily lowers the level of the groundwater (Fig. 3.5).

A wellpoint system (Fig. 3.6) comprises the following:

- an electric or diesel centrifugal pump (Fig. 3.7) with a high vacuum capacity to pump the water to a higher level;
- an intake manifold (flexible hoses) to connect the wellpoint to the pump;
- wellpoints with a series of metallic or plastic filters to draw out the water without drawing solid particles from the ground;
- discharge pipes to carry the water away from the excavated area.

If the water needs to be carried over a long distance away from the excavated area, supplementary booster pumps will also have to be employed.

In ideal conditions, the maximum suction lift of a wellpoint system would be 8.7 m. In real site conditions, however, the performance of the pumps is drastically reduced, and for particularly deep excavations to lower the level of the groundwater by more than 4 metres, wellpoints are installed in steps. In so doing, the water head is reduced in successive steps by installing wellpoints at different levels. A wellpoint system allows an area of a site to be dried off so construction work may be carried out below the level of the groundwater.

Please note: the drainage system must not be switched until the reinforced concrete structure has cured sufficiently to withstand the buoyancy force exerted on the site.

WATERPROOFING STRUCTURES INSTALLED BELOW GROUND LEVEL

The type of ground influences the choice of the most suitable drainage system. According to the various types of ground and their grain distribution, various drainage systems may be adopted as described below.

- Pebbles (diameter > 60 mm): to drain off ground formed by pebbles, one of two well systems may be used. The first system involves drilling a well at ground level using a continuous coring auger. The second technique involves positioning a series of perforated concrete rings using an excavator. Although this technique has a much lower cost, each site needs to be carefully assessed to verify if such a system is feasible. Both systems use an open air pumping system with either a surface mount pump or a submerged pump.

- Gravel (20 mm < diameter < 60 mm): the most suitable drainage systems are formed by a system of wells or a wellpoint system for gravel. The well system is similar to the one described for pebbles and is used when it is not possible to drive in wellpoint rods. Regarding the wellpoint technique, it is very similar to the traditional system by driving in rods with a high pressure pump, while the sand filter is replaced with a special tip for gravel called a probe. Drying off ground with a gravel wellpoint is a system which, unlike draining off water with a well, works by creating a cone of depression in the water table which forcedly draws the water from the subsoil and increases its velocity. With the well drainage system, no cone of depression is formed in the water table and the water is drained off by gravitational force, that is, by running into the well. Its velocity is lower compared with the velocity induced by a wellpoint system and as a result, the water requires more time to reach the well and the flow rate is lower. In fact, according to the size of the site and the piezometric level to be reached, if the drainage capacity of a gravel matrix aquifer is interpreted correctly, the number of pumps required and, therefore, the overall costs may be reduced.



Fig. 3.7 – Centrifugal pump used in a wellpoint system

- Sand with a gravel matrix (0.6 mm < diameter < 20 mm): sandy soil with a gravel matrix is basically drained off with a wellpoint system fitted with anti-sand filters or gravel probes, according to the percentage of gravel in the ground. In certain cases, it may be necessary to install a mixed system to get the best results. The wellpoint rods, with either anti-sand filters or gravel probes, are driven into the ground under pressure.

- Clean sand (0.2 mm < diameter < 0.6 mm): clean sand is the ideal ground for installing a wellpoint system with micro-pore filters. Although it is unlikely that this type of ground is homogenous with uniform isotropy and grain size distribution, a wellpoint system is almost always a guarantee that the depth to excavate may be reached in dry conditions, with an acceptable balance between the results obtained and the overall cost of the system. The system is also relatively easy to install, in that the rods are simply driven in under pressure.

- Sand with a muddy matrix (0.02 mm < diameter < 0.2 mm): sand with a muddy matrix may be drained off using a traditional wellpoint system with anti-sand filters. If the muddy matrix does not have an effect on the pumps, the rods may be driven in under pressure. If, however, the muddy matrix tends to clog the filters, a pre-filtering system must also be installed by boring a hole in the ground.

- Silt (0.006 mm < diameter < 0.02 mm): the most suitable drainage system for silty ground is one with a pre-filter, that is, by boring the ground, inserting a drainage sleeve and then bleeding and rinsing the wellpoint with a suitable pump.

- Silt with a clay matrix (0.002 mm < diam. < 0.006 mm): clayey silt may be drained off using one of the following systems:

- wellpoint system with a pre-filter;

WATERPROOFING STRUCTURES INSTALLED BELOW GROUND LEVEL

- installation of perforated concrete rings using an excavator. The use of this type of system (much more economical after assessing its feasibility on site) depends on the stability of the side walls of the excavations.

- laying a drainage pipe after forming a drainage trench.

• Clay (diameter < 0,002): when the ground is clayey, there are basically two types of drainage systems available:

- wellpoint system with a pre-filter;

- laying a drainage pipe after forming a drainage trench.

In rocky ground, the water circulates through channels which are difficult to trace during the preliminary phase. In such conditions, therefore, it is impossible to get good results with a wellpoint system. A wellpoint system may not be able to control the level of the groundwater in large-grained ground or ground with high hydraulic conductivity. In these cases, drainage wells with electric immersion pumps are used. The wells are designed according to the geology of the subsoil and the amount and chemical and physical characteristics of the water to be drained off. The design of the wells must include:

• the boring method (percussion or rotating);

• the type and length of the filter required and the depth at which it must be installed;

• the grain distribution if drainage layers are used.

Wells are made according to the following steps:

• vertical holes are bored in the ground using a percussion or rotating (direct rotation or inverse rotation) boring machine, with the core pulverised by a crushing cone. Liners are recommended to protect the

vertical side walls of the bore. The depth of the bore must be such that it reaches the lowest theoretical level required for the groundwater plus 3 m more, to form a permanent buffer.

• filters and drainage pipes with a 1 mm filtering capacity are inserted into the bore;

• gauged inert material is used to fill any gaps between the drainage pipes and the vertical sides of the bore;

• the well is cemented off and isolated.

After inserting the filters and pipes and selecting the grain size and mineral type for draining, the well must be cemented to isolate the water from the surface and between each well. The final operations is to finish off the well so that it is as efficient as possible and to avoid sand or impurities being dragged from the water drained off.

If the groundwater is on the surface and there is only a small amount of water to be controlled, horizontal gravitational drainage systems may be used (Fig. 3.8). Trenches are dug at 90° to the flow of the water to channel the water towards defined collection points. Flexible PVC pipes lined with perforated non-woven fabric to stop the water releasing finer particles into the ground are positioned in the collection points. In order to increase the drainage capacity of the system, the PVC pipes may also be connected to a battery of suction pumps. The drainage pipes are laid by a special machine which operates in a continuous cycle and which may reach depths of up to 5 m. Once all construction operations have been completed, the PVC pipes are left buried in the ground. With this system, the time required to drain off the water is considerably reduced and the area is totally accessible. However, large spaces are required for the laying equipment to carry out manoeuvres and there are no utilities available underground.

After taking a look at the various drainage systems available, according to the type of ground where the groundwater needs to be lowered, it is quite clear that, before designing the drainage system, an in-depth analysis must be carried out to obtain all the data required to calculate and determine the most suitable drainage system.

And only after obtaining a complete understanding of the type of ground, its stratographic composition and the presence of groundwater may the next phase of identifying the most suitable type of excavation be tackled.

4. EXCAVATION WORK

In the building sector, excavation work refers to the removal of rock and/or ground from its original location to form cavities with various shapes and dimensions to carry out engineering and construction work.

Excavation work may be divided as follows:

- open air excavations;
- excavations in tunnels and passages.

Open air excavations may then be further divided into **fixed section** (or trenching) **and stripping** (or open section) **types**. Fixed section excavations are the same width, or narrower, than the depth of the excavation and starts from the surface of the ground or the bottom of a previous stripping excavation.

Going further into detail:

- *fixed section* excavations are those in which the length of the horizontal sides is less than the depth. They are generally used for foundation plinths or ground beams.
- *trenching excavations* are *continuous* with a narrow section. They are generally used for laying pipe-lines, buried utilities, etc.

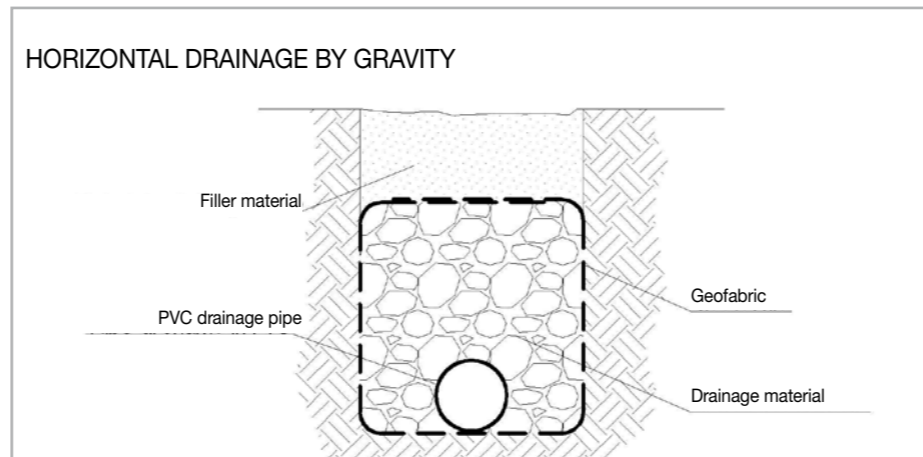

Fig. 3.8 – Schematic view of a horizontal gravitational drainage system, with and without a drainage pipe



Fig. 4.1 – Stripped ground without confinement

Stripping (or open section) **excavations** (Fig. 4.1) are those in which the horizontal surface is much larger than the depth of the excavation and the section is sufficiently large to allow access for vehicles right up to the front of the excavation (direct access using temporary ramps) so that the material dug out may be loaded directly on trucks. Stripping is the most simple, economical and natural form of excavation work to build structures below ground level, and basically uses the friction angle in the ground to stabilise the sides of the excavation. If water or rain are present, apart from the friction angle of the ground, the permeability of the ground is also important. In fact, the stability of the sides of the excavation is heavily influenced by these parameters, since there is no vegetation to hold the ground together, as normally occurs on natural slopes. Generally speaking, the conditions described above are not the real limits to this system. In certain cases, there are other insurmountable problems for this system, such as the large spaces required, which increase drastically according to the depth of the excavation and the permanent loads on the adjacent area. In fact, when construction work is carried out in built-up areas or close to transport networks, apart from the density of the saturated ground, the loads of these structures must also be taken into consideration. When these conditions are present, the excavation must be confined by inserting support structures, which have a double advantage: the sides of the excavation may be vertical which considerably reduces the overall area to only what is really necessary for the construction work, and they also support the ground adjacent to the excavation area and guarantee the stability of the surrounding buildings.

The support structures used to contain the side walls of the excavation are generally similar to bulkheads: relatively thin, vertical structures driven into the ground at a certain depth below the level of the excavation, to form a support which is sufficiently robust to contrast the thrust from the embankment, the water and any other loads. These structures may be installed with or without anchoring systems. In the first case, stability is guaranteed by the passive resistance of the ground on the embedded

WATERPROOFING STRUCTURES INSTALLED BELOW GROUND LEVEL

part of the structure and the behaviour of the bulkhead is more or less like that of a bracket. In the second case, stability is also guaranteed by stays clamped in the ground using special mortar made from grout mixed with **CABLEJET** plasticising, expansive additive. The bulkheads may be made from pre-fabricated sheet piling (overlapped and driven into the ground), reinforced concrete diaphragms built directly on site, by piles bored into the ground (side by side or at angles) or by micro-piles.

The sheet piling is made from steel and is available with various profiles to obtain whatever modulus of resistance is required.

Diaphragms (Fig. 4.2) are built directly on site, by digging a trench in which the concrete is then poured. They are formed by panels generally between 50 and 120 mm thick, at least 200 cm wide and may be extremely long, much longer than pre-fabricated panels which are usually up to only 15-20 m in length.

Piles (Fig. 4.3) are straight elements made from reinforced concrete, and their size depends on the cohesion of the ground and the depth to which they are driven. The pitch between each pile depends on the characteristics of the ground, the amount of water in the ground and the size of each pile.

Micro-piles are piles with a diameter less than 300 mm if bored into the ground and 150 mm if driven in. Micro-piles are reinforced with a steel tube or profile or a steel cage made from rebar, while the filler material is made from either cementitious mortar or beton.

Steel sheet piling bulkheads are generally more flexible than diaphragms. This fact must be considered during the design phase because the evolution, distribution and the final action of the ground also depend on how the support structures deform and how much they deflect.

Bulkheads are generally constructed before excavating the ground to the depth required. The vertical bulkhead is usually installed around the perimeter of the excavation before placing the topping beams. The ground is then excavated inside the perimeter to the depth of the first row of stays (if used), the stays are inserted and then tightened. Excavation work is then carried out level by level, following the same procedure as described above until reaching the depth required.

Bulkheads without anchorage points are generally acceptable for shallow excavations, since the module of resistance required increases quickly as



Fig. 4.2 – Stripped ground confined by diaphragms



Fig. 4.3 – Stripped ground confined by bored piles

the depth of the ground to be supported increases and because they are subject to considerable lateral flexure. Bulkheads with anchorage points are used for deeper excavations and especially when the area excavated is particularly widespread. The use of anchorage points reduces the lateral movements, the maximum bending moment and the depth they are driven in. The position of the anchorage points (Fig. 4.4) for the stays must be such that the active thrust prism (ground lift) acting on the bulkhead does not interfere with the passive resistance due to the action of the anchorage points. Anchorage stays fixed in place by a rib injected under pressure are generally butted to the bulkhead with an anchor plate or other such anchoring means, which is used to transmit the pulling force of the stay to the structure.

If there are constructions below ground level in the vicinity of the excavation, it is impossible to anchor the bulkheads. In these cases, the Top-Down system will have to be adopted (Fig. 4.5), which also allows the surface at ground level to be prepared much more quickly than with conventional systems. The Top-Down system means building the construction starting from the top and working downwards, the opposite of the traditional method. After completing the temporary structure, the ground is excavated to the depth required for the floor slab, which is then poured directly on the ground (often with the use of plastic sheets to improve its final appearance). After waiting the standard time before stripping the floor slab, excavate under the floor slab by passing through holes previously made or from an access ramp. With this method, after just a few months, the roads, squares and gardens on which the work is being carried out are available for public use. From this moment on, the only area occupied by the site is the access ramp. The floor slabs are anchored to the temporary side structures and become self-bearing without building the walls below. The reinforcement tie rods for the poured concrete are then inserted downwards and bent to shape. After completing all the floor slabs, the uprights are then dug out and the concrete is poured in, with spaces in the floor slabs where the concrete is poured in. Reinforcement tie rods and construction joints are handled exactly the opposite way to traditional methods. In so doing, construction work is carried out working downwards until the foundations are reached.

WATERPROOFING STRUCTURES INSTALLED BELOW GROUND LEVEL

In certain cases, the need to exploit areas below ground level derives from the lack of new building land and spaces and the high density of the built-up areas in some cities. Construction work below ground level also represents a chance to be exploited for building auxiliary and service structures (such as car-parks and production units). Structures below ground level come into contact with the damp in the ground, with water which percolates upwards and with groundwater and, therefore, need to be waterproofed to avoid infiltrations compromising the functionality of the rooms inside such structures. Structures also need to be waterproofed to protect the construction from deteriorating due to the presence of chemical agents in the ground or carried by water into the construction materials, to guarantee a longer service life of the structure.

5. MAPEI WATERPROOFING SYSTEMS FOR FOUNDATION STRUCTURES

5.1 WHY WATERPROOF?

From a theoretical point of view, good concrete has a very low coefficient of permeability k (see Section 3.2), so it may be considered more or less impermeable to water under pressure. UNI 9858 : 1991 (replaced by EN 206-1 : 2001) established that for a concrete to be considered impermeable, its water/cement ratio must be < 0.55 . In real conditions, in spite of the most modern production techniques being employed, it is extremely difficult to make concrete which is perfect throughout its entire bulk. In fact, even the smallest imperfection (cracks, honey combs, etc.) and construction and structural joints form a preferential passage for water. There are various phenomena which generate cracks in concrete, such as shrinkage during curing, seismic activity, settling of foundations and vibrations caused by traffic. It is obviously impossible to keep all these phenomena under control and be certain that there are no cracks in the concrete after it has been poured. Also, water which penetrates

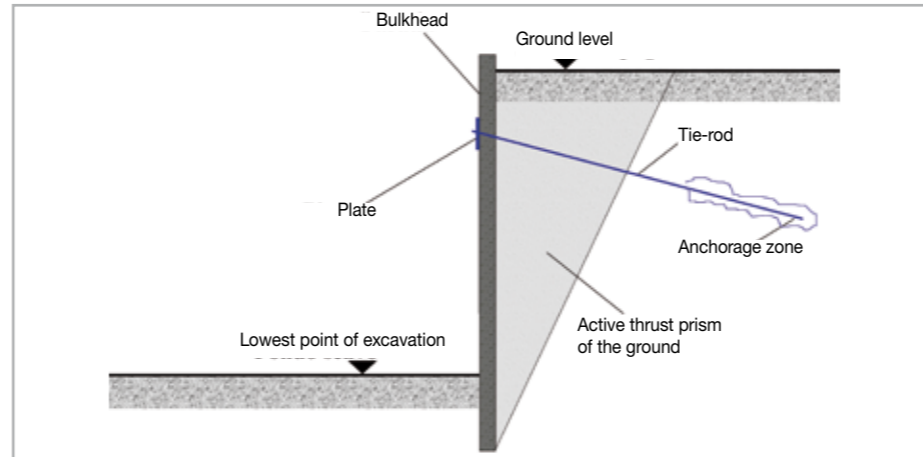

Fig. 4.4 – Anchorage points for stays inserted out of the ground's active thrust zone



Fig. 4.5 – Example of a Top-Down construction. Excavation work carried out under the reinforced concrete foundation pad cast before excavating

into the concrete is acid, and therefore aggressive for both the base components of the concrete and for the reinforcement rods. Considering the above, the only solution to adopt to stop water penetrating into the concrete and infiltrating into the rooms below ground level, is to use a waterproofing system.

When a waterproofing system needs to be installed, the highest point of the groundwater must be considered, whether the level is constant or influenced by temporary events and by the type of ground. In fact, the characteristic of ground with good drainage, comprising mainly sand and gravel, is that it releases the water very quickly, but transfers large amounts of water just as quickly around the structure, thus generating high pressure. With compact, impermeable ground on the other hand, such as clayey ground, the water is released very slowly with the risk of water collecting and generating infiltrations in rooms below ground level. Even when there is no groundwater, the infiltration of rainwater provokes aggression action on the structure with the possibility of water permeating into rooms below ground level.

Therefore, from a practical point of view, waterproofing may be installed to solve three different types of problem:

- damp present in drainage ground which does not cause water to accumulate during excavation work;
- non-draining ground in excavations which causes water to accumulate;
- ground with water under pressure.

In the first case, the waterproofing layer is not subject to high hydrostatic loads. This is mainly due to the formation of the ground, generally formed by sand and gravel, which have good drainage characteristics and, therefore, are able to release the water which percolates quite quickly

WATERPROOFING STRUCTURES INSTALLED BELOW GROUND LEVEL

without it collecting. This condition may also be achieved on ground with poor drainage by applying a suitable drainage system at the base of the foundations and on all the vertical surfaces.

In the second case, the presence of compact ground or clayey ground with no drainage system causes water to collect. Excavation operations modify the intrinsic balance between the ground and the water. After completing the construction work and filling in the excavated areas, the ground will be considerably less compact and more porous, therefore, compared with the adjacent ground. This will form a drainage area towards which the water from the adjacent ground will tend to migrate and generate temporary, high pressures, also due to the fact that the water is released very slowly. It is worth remembering that a water head of one metre is equal to a pressure of 1000 kg/m² (Fig. 5.1).

In the third case the water under pressure, due to the presence of groundwater, is in direct contact with the structure and will have to be considered when choosing both the waterproofing system and the type of structure itself. Therefore, when groundwater is present, even if only during certain periods of the year, a foundation structure will have to be installed which has the capacity of contrasting the lift from water under pressure. The only foundation structure with this capacity is a foundation pad.

5.2 MAPEPROOF AND BENTONITE

MAPEI offers a wide range of products for waterproofing structures below ground level (refer to the Waterproofing Products catalogue) which are suitable for both new constructions and for repair work on existing structures. Below is a brief description of MAPEI **MAPEPROOF** and **MAPEPROOF LW** bentonite sheets, which completes the information available on the Technical Data Sheets for each product and in the Waterproofing Products catalogue.

MAPEPROOF and **MAPEPROOF LW** are composed of two layers of polypropylene geo-textile fabric. The upper layer is a non-woven fabric while the lower layer is a woven fabric. They are needle-punched together

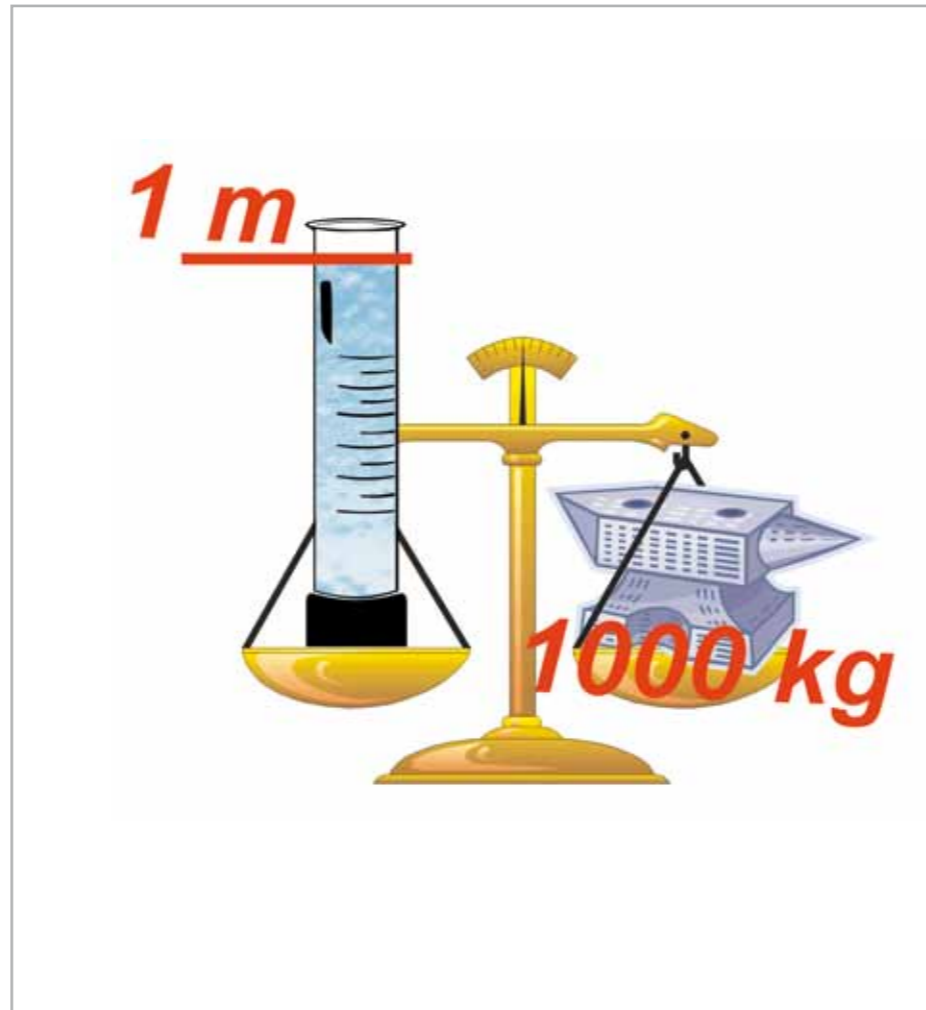

Fig. 5.1 – A one meter head of water generates a load of 1000 kg

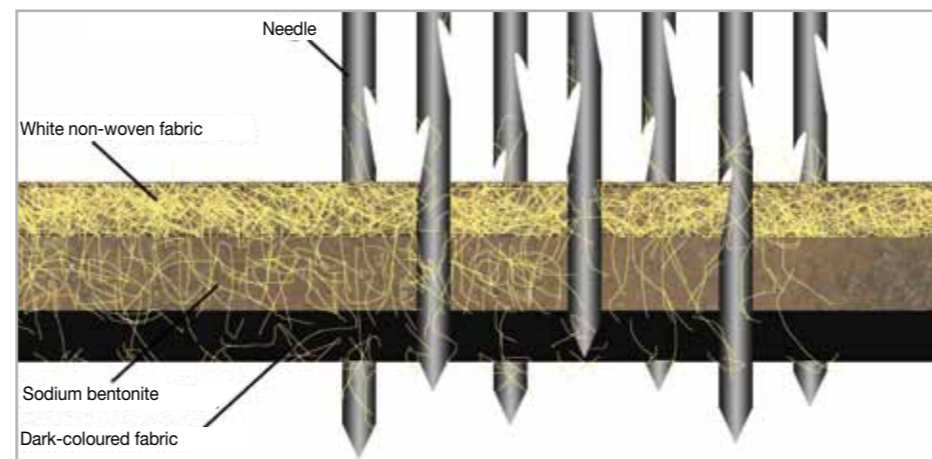

Fig. 5.2 – A schematic view of the needle-punch process

with a layer of natural sodium bentonite sandwiched between the two layers. The needle-punch process (Fig. 5.2) involves the use of thousands of needles with a hooked tip, which force part of the fibres of the upper layer of non-woven fabric through the middle layer of bentonite, and stitch it to the lower support layer of geo-textile fabric. Thanks to this special weaving system, the natural sodium bentonite contained in **MAPEPROOF** remains fixed in place, even after hydration. The special grain size of the bentonite, together with the type of non-woven geo-textile fabric, guarantee saturation of the non-woven fabric which is in contact with the poured concrete. This characteristic gives the product an important technical advantage: the fabric may be applied after pouring the concrete (Fig. 5.3). The difference between the two sheets is the amount of natural sodium bentonite each one contains: **MAPEPROOF** contains 5.1 g/m², while **MAPEPROOF LW** contains 4.1 g/m².

For this reason, **MAPEPROOF LW** is only recommended for waterproofing concrete structures below ground level with a hydraulic head of less than 5 m. According to ASTM D 5887, MAPEI bentonite sheets have a permeability coefficient $k < 1E-11$ m/s. Thus, on the basis of the equation $v=ki$ (Section 3.2), the velocity v at which the water passes through the sheet is so low that it is practically zero.

The basis of the waterproofing capacity of **MAPEPROOF** sheets is bentonite, a clay mineral composed mainly of montmorillonite and sodium. Bentonite originates from the alteration of volcanic ash. It devitrifies in a watery environment with removal of a part of the silica content. The montmorillonite is then crystallised, and its chemical content depends on the chemical content of the water in which the volcanic ash precipitated. Bentonite is generally divided into two types: sodium bentonite and calcium bentonite. Sodium bentonite expands when it comes into contact with moisture which makes it particularly suitable for sealing purposes and to create waterproof barriers.

Calcium bentonite is a useful absorbent of ions in solution as well as fats and oil, which is why it was probably one of the first cleaning agents used on an industrial scale.

WATERPROOFING STRUCTURES INSTALLED BELOW GROUND LEVEL

Bentonite is used in various sectors. Because of its viscosifying properties, it is used in cement, adhesives, and ceramics and as a binder in the production of pellets for the steel industry. It is also used in cosmetics for treating acne and oily skin because of its capacity to absorb excess sebum and clean pores in the skin. Another interesting characteristic of bentonite is its capacity to absorb large quantities of protein molecules from watery solutions, which makes it an excellent agent to reduce the level of proteins contained in white wine.

Montmorillonite, from which bentonite is made, has a special lamellar crystalline structure and is non-toxic and chemically inert. The high specific surface area of bentonite and the negative charge of the lamellas which form the structure give this mineral the property to absorb and adsorb various elements.

The mechanism through which bentonite is able to hold water within its molecular structure is based on its capacity to swell in the presence of water and moisture. Confined, swollen bentonite blocks the passage of water between the particles (Fig. 5.4). This is due to both an increase in the length of the route of the water molecules and the formation of a stable structure which maintains the energy bond between the sodium ions and the water at a high level. This stops the water passing through the bentonite and it is trapped inside the crystalline structure. What actually happens is that, in the presence of water or moisture, the bentonite forms a waterproof, water-repellent gel. Hydration rates and times vary according to a number of factors, including the grain size of the mineral and the surrounding temperature where the phenomenon occurs. The waterproofing properties of bentonite laid on site is demonstrated when expansion of the bentonite is blocked by the foundation structure. The bentonite hydrates and increases in volume according to the space available. This increase in volume, as may be easily imagined, allows the material to block the passage of the water through its structure and stops it migrating laterally.

Expanded bentonite obstructs the cavities and saturates cracks up to 3



Fig. 5.3 – An example of MAPEPROOF applied after casting

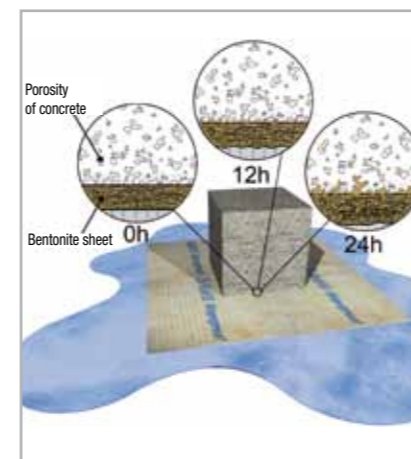

Fig. 5.4 – Hydration process of sodium bentonite contained in MAPEPROOF and MAPEPROOF LW. If the bentonite is confined, when it swells it blocks porosity and impedes the passage of water

mm wide caused by hygrometric shrinkage or settling after pouring the concrete.

6. SPECIFICATIONS FOR FOUNDATION CONCRETE

Before analysing typical site conditions and problems and suitable technical solutions to be adopted, a brief overview of foundation structures and the concrete used for such structures would be very useful. As discussed previously, with construction work below ground level in the presence of ground water, whether it is continuous or due to temporary events, the only type of structure capable of withstanding hydrostatic lift is a continuous foundation. As far as durability is concerned, the concrete must be designed according to EN 206-1 : 2001, which defines the environmental exposition classes (Table 1a-b), on the basis of which the limit values are defined (Table 2) for the composition and properties of concrete: the maximum water/cement ratio, the minimum strength class and the minimum cement content.

Concrete must be well vibrated to eliminate gravel clusters, and suitable admixes must be included so it fills all the spaces and gaps and flows freely around the steel reinforcement. In this case, we recommend using a super-plasticising admix from the **DYNAMON** range, produced by MAPEI S.p.A. The **DYNAMON** system is based on DPP (Designed Performance Polymer) technology, a new chemical process which, through total monomer design (exclusive know-how of MAPEI), allows the characteristics of the admix to be modulated according to the specific performance requirements of the concrete employed. Concrete made with products from the **DYNAMON** range is easy to apply while fresh and offers very high mechanical performance when hardened.

WATERPROOFING STRUCTURES INSTALLED BELOW GROUND LEVEL

EXPOSURE CLASSES		
Class denomination	Type of conditions and surroundings	Examples of conditions and surroundings when the exposure classes may be applied
1 No risk of corrosion or attack		
X0	Concrete with no metallic reinforcement or inserts: all exposures except freeze/thaw cycles and chemical attack. Concrete with metallic reinforcement or inserts: in very dry surroundings.	In buildings with a relatively low level of damp. Concrete without reinforcement inside buildings. Concrete without reinforcement embedded in non-aggressive ground or water. Concrete without reinforcement subjected to wet/dry cycles but not subjected to abrasion, freezing weather or chemical attack.
2 Corrosion induced by carbonatation Note – The levels of humidity refer to those present in the concrete or material used to cover steel reinforcement or metal inserts. In many cases, such levels may be considered as the same as the surrounding environment. In such cases, classification of the surrounding may be considered sufficient. This may not necessarily be the case if there is a barrier between the concrete and the surroundings.		
XC1	Dry or permanently wet	In buildings with a relatively low level of damp. Conventional reinforced concrete or pre-compressed concrete with the exposed surface in the building, apart from the areas exposed to condensation or immersed in water.
XC2	Wet, rarely dry	Parts of structures for containing liquids and foundations. Conventional reinforced concrete or pre-compressed concrete usually immersed in water or non-aggressive ground.
XC3	Moderately damp	Conventional reinforced concrete or pre-compressed concrete with external surfaces protected from the rain, or inside areas with a moderate to high level of humidity.
XC4	Cyclically wet and dry	Conventional reinforced concrete or pre-compressed concrete cast outside with surfaces subjected to dry/wet cycles. Natural-finish concrete in urban environments. Surfaces in contact with water not included in class XC2.
3 Corrosion induced by chlorides excluding chlorides from seawater		
XD1	Moderately damp	Conventional reinforced concrete or pre-compressed concrete on surfaces or parts of bridges and viaducts exposed to sprayed water containing chlorides.
XD2	Wet, rarely dry	Conventional reinforced concrete or pre-compressed concrete in structural elements completely immersed in water, including industrial water, containing chlorides (swimming pools).
XD3	Cyclically wet and dry	Conventional reinforced concrete or pre-compressed concrete for structural elements directly subjected to de-icing agents or sprayed water containing de-icing agents. Conventional reinforced concrete or pre-compressed concrete for elements with one surface immersed in water containing chlorides and the other surface exposed to the air. Parts of bridges and floors in carparks.
4 Corrosion induced by chlorides except chlorides from seawater		
XS1	Exposed to salty seawater but not directly in contact with seawater	Conventional reinforced concrete or pre-compressed concrete with structural elements on or near to the coast.
XS2	Permanently submerged	Conventional reinforced concrete or pre-compressed concrete for marine structures completely immersed in water.
XS3	Zones exposed to sea-spray or high tides.	Conventional reinforced concrete or pre-compressed concrete with structural elements exposed to tidal areas or for zones exposed to sea-spray or waves.
5 Attack from freeze/thaw cycles with or without de-icing agents		
XF1	Moderate saturation of water without de-icing agents	Vertical concrete surfaces, such as façades of columns exposed to the rain and freezing weather. Non-vertical surfaces which are not completely saturated but exposed to freezing weather, rain or water.
XF2	Moderate saturation of water with de-icing agents	Elements such as parts of bridges which would otherwise be classified as XF1, but which are directly or indirectly exposed to de-icing agents.
XF3	High saturation of water without de-icing agents	Horizontal surfaces in buildings where water may accumulate and which may be subjected to freezing weather and elements subjected to frequent wetting and exposed to freezing weather.
XF4	High saturation of water with de-icing agents or with seawater	Horizontal surfaces, such as roads and floors exposed to freezing weather and indirectly or directly to de-icing salts, and elements exposed to freezing weather and subjected to frequent wetting with de-icing agents or seawater.

Class denomination	Type of conditions and surroundings	Examples of conditions and surroundings when the exposure classes may be applied
6 Attacco chimico**)		
XA1	Weak chemically aggressive environment according to Table 2 from EN 206-1	Sludge basins and decantation basins. Containers and basins for waste water.
XA2	Moderate chemically aggressive environment according to Table 2 from EN 206-1	Structural elements or walls in contact with aggressive ground.
XA3	High chemically aggressive environment according to Table 2 from EN 206-1	Structural elements or walls in contact with highly aggressive industrial water. Containers for forage, animal feed and sewage. Cooling towers for industrial fumes and discharge gases.

*) the level of saturation in the second column reflects the frequency at which freezing occurs in saturated conditions:

- moderate: occasional freezing in saturated conditions;
- high: high frequency of freezing in saturated conditions.

***) By water from the ground and flowing water

Tab 1a-b – Table 1 from EN 206-1:2001 with indications of environmental exposure classes.

LIMIT VALUES FOR THE COMPOSITION AND PROPERTIES OF CONCRETE																	
	EXPOSURE CLASSES																
	No risk of corrosion to steel reinforcement	Corrosion of steel reinforcement induced by carbonatation				Corrosion of steel reinforcement induced by chlorides						Environment with freeze/thaw cycles				Aggressive environment due to chemical attack	
		X0	XC1	XC2	XC3	XC4	Seawater			Chloride from other sources			XF1	XF2	XF3	XF4	XA1
Maximum water/cement ratio	-	0,60	0,55	0,50	0,50	0,50	0,45	0,55	0,50	0,45	0,50	0,50	0,45	0,55	0,50	0,45	
Minimum strength class	C12/15	C25/30	C28/35	C32/40	C32/40	C35/45	C28/35	C32/40	C35/45	32/40	25/30	28/35	28,35	32/40	35/45		
Minimum cement content (kg/m ³)	-	300	320	340	340	360	320	340	360	320	340	360	320	340	360		
Minimum air content (%)													3,0 ^{a)}				
Other requirements														Aggregates in compliance with UNI EN 12620 for sufficient resistance to freeze/thaw cycles	Cement resistant to sulphates) is required		

*) Table 7 from EN 206-1 mentions class C8/10 which corresponds to specific concrete for substrates and for covering purposes.

For this class, durability regarding water and aggressive ground must be defined.

a) When the concrete does not contain added air, its performance must be checked compared with aerated concrete with a proven value for resistance to freeze/thaw cycles determined according to UNI 7087 for respective exposure class.

b) If the presence of sulphates leads to exposure classes XA2 and XA3, it is essential that cement resistant to sulphates according to UNI 9156 is used

Tab 2 – Table 4 from EN 206-1:2001 with indications of limit values for the composition and properties of concrete.



7. WATERPROOFING NEW STRUCTURES BELOW GROUND LEVEL

This section will discuss the problem of waterproofing new structures below ground level, and will offer a series of technical solutions to be adopted, the products required and methods and techniques to install and apply the products. All the information will be accompanied by specific technical details.

When excavation work is carried out, an artificial space is created in which the part of the structure below ground level will be installed. The hydrogeological balance of the site is modified and, even if there is no groundwater present, after stripping the ground, rainwater and precipitations will collect in the artificial space and form an artificial pond. In such conditions, the structures of the building will have to be made waterproof to protect them from large quantities of water which collects in the area below ground level around the construction.

In view of the above, it is clear that a structure must be waterproofed correctly using the so-called “basin” or “pouch” method which is suitable to contrast the lift from the water, especially from groundwater. The waterproofing system is applied by sticking it to the structure (foundations and walls) with no point left uncovered.

There now follows a description of a series of waterproofing interventions to be carried out on site to guarantee that structures below ground level are watertight.

The first intervention which may be necessary to carry out on site, but which is often overlooked, is to waterproof the base of jib cranes when they are positioned in the foundation structure, which should then be followed by waterproofing the lift wells. Waterproofing of lift wells is often overlooked, and must be carried out before waterproofing the plinth. This should be carried out because, as we will see later, the base of the lift well is usually the lowest point of the entire construction. In the case of foundation pads resting on piles, before preparing the area for laying the bentonite sheets to waterproof the structure, the heads of the piles must be sealed.

The method applied to lay **MAPEPROOF** will be different according to the type of excavation. In the case of excavations without confinement (see Section 4), the bentonite sheets must be hemmed up on formwork. With confined excavations, on the other hand, the sheets must be applied on the containment bulkheads on the side walls of the excavation with one of the following four distinct laying situations: on sheetpiling, piles, micro-piles and diaphragms.

In excavations without confinement, waterproofing of the reinforced concrete facing walls is carried out after pouring the concrete. MAPEI offers a range of products with different characteristics and performance levels for this type of application:

- **MAPEPROOF** (see Section 5.2);
- **MAPEPROOF LW** (see Section 5.2);
- **MAPELASTIC FOUNDATION** two-component, flexible cementitious mortar for waterproofing surfaces subject to negative and positive hydraulic lift;
- **PLASTIMUL** bitumen waterproofing emulsion;
- **PLASTIMUL 1K SUPER PLUS** solvent-free, one-component, quick-drying, low-shrinkage, high-yield, high-flexibility bitumen waterproofing emulsion containing polystyrene beads and rubber granules;
- **PLASTIMUL 2K PLUS** solvent-free, one-component, quick-drying, low-shrinkage, high-flexibility bitumen waterproofing emulsion containing cellulose fibres;
- **PLASTIMUL 2K SUPER** solvent-free, two-component, quick-drying, low-shrinkage, high-flexibility bitumen waterproofing emulsion containing polystyrene spheres.

Special care must be taken when sealing around structural joints, elements which pass through the foundation pad and side walls, drainage wells and wellpoint rods. Waterproofing interventions on access ramps below ground level and depuration tanks will be illustrated later.

WATERPROOFING STRUCTURES INSTALLED BELOW GROUND LEVEL

7.1 SEALING CONSTRUCTION JOINTS

Construction joints represent a point of discontinuity in the poured concrete on both horizontal and vertical faces. They must be made watertight to avoid the points of discontinuity forming a preferential route for water. MAPEI offers a product developed specifically for sealing construction joints called **IDROSTOP B25** (Fig. 7.1-2). It forms a hydro-expanding, self-sealing joint and has a section of 20x25 mm. It is made from a mixture of natural sodium bentonite and polymers, which give the product excellent characteristics of compactness, flexibility and stability. The swelling process takes place in a controlled, uniform and gradual manner without the risk of altering the equilibrium of the mixture. After swelling, which occurs when the product comes into contact with water, **IDROSTOP B25** adapts perfectly to the volume defined by the confinement and, thanks to this special characteristic, perfectly seals both construction joints and localised gravel clusters in the cast concrete. Before applying **IDROSTOP B25**, carefully clean the surface to eliminate all traces of debris, and especially the slurry which bleeds from the surface and usually forms when compacting the cementitious conglomerate. Then nail a rib (1 nail every 25 cm) along the middle of the vertical wall between the steel reinforcement. Join the ends together by simply laying the pieces alongside each other for at least 6 cm (Fig. 7.3). As an alternative to **IDROSTOP B25**, **IDROSTOP** pre-formed, hydro-expanding, acrylic polymer tape may be used. This product was developed to make joints in the construction industry which remain waterproof up to a pressure of 5 atm.

The following paragraphs illustrate specific cases in which **IDROSTOP B25** must be used and how to lay the product.

7.2 WATERPROOFING THE BASE OF A JIB CRANE

The base of a jib crane (Fig. 7.4) is made by excavating a hole which is then lined with a waterproofing system before pouring in the concrete. Below is a description of the phases to be carried out to waterproof the excavation.



Fig. 7.1 - IDROSTOP B25 applied to seal horizontal and vertical construction joints

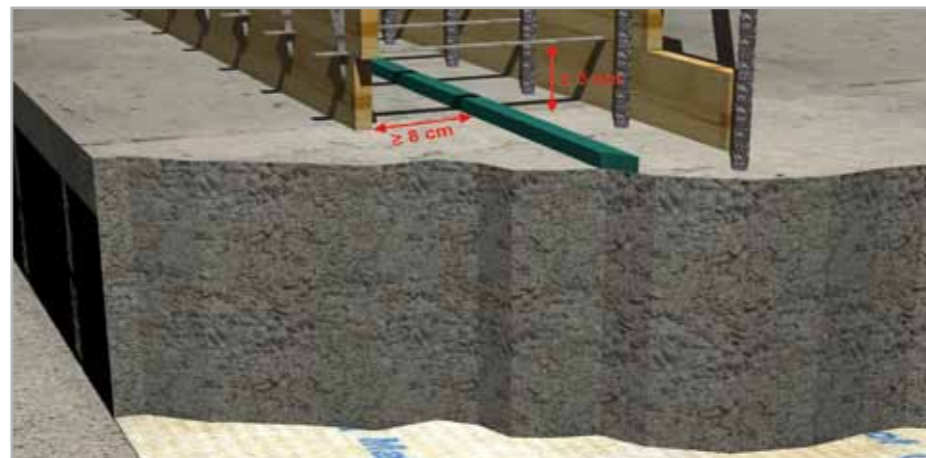

Fig. 7.2 - The minimum distances which must be maintained between IDROSTOP B25 and the blades in formwork, and between IDROSTOP B25 and the outer surface of concrete, to guarantee correct confinement



Fig. 7.3 - Joint between the ends of two strips of IDROSTOP B25 by simply laying them alongside each other for at least 6 cm

- To form a suitable laying surface and make application of the waterproofing system easier, the bottom of the excavation must be evened out by applying a layer of lean concrete about 10 cm thick.

- To lay the vertical part of the waterproofing system, install formwork on which the **MAPEPROOF** will then be applied. Position the underside (the dark side) of the geo-textile polypropylene fabric on the substrate and overlap the edges of the sheets by at least 10 cm. Fasten the sheets in place with nails and **MAPEPROOF CD** polyethylene washers approximately every 30 cm.

- After laying the system on the vertical surfaces, lay the **MAPEPROOF** on the horizontal surface by positioning the underside (the dark side) of the geo-textile polypropylene fabric on the surface of the lean concrete and the upper side of the fabric (the white side) on the vertical surfaces. Overlap the edges of the sheets by at least 10 cm. Fasten the sheets in place on the horizontal surface with nails and **MAPEPROOF CD** polyethylene washers approximately every 50 cm. Avoid forming creases when laying the fabric on the lean concrete.

- After laying the bentonite sheets, the steel reinforcement for the base must be placed in position, with spacers between the reinforcement and the **MAPEPROOF** sheets to guarantee that the concrete flows freely between the reinforcement and the bentonite sheets and completely covers the reinforcement. Then pour in the concrete to form the base for the crane so that the height of the top face of the base coincides with the height of the foundation pad in which it will be incorporated.

7.3 WATERPROOFING A LIFT WELL

A lift well is without a doubt the part of a construction which is most likely to come into contact with groundwater. In fact, it often happens that lift wells are waterproofed after construction to eliminate problems of water infiltration and to make the electrical equipment of the lift safe. This part

WATERPROOFING STRUCTURES INSTALLED BELOW GROUND LEVEL

of the structure, therefore, is the first one to consider when designing a waterproofing system to protect it against the aggressive action of water.

Excavations for lift wells may be carried out using the following methods:

a) with a determined shape (Fig. 7.5);

b) by stripping.

In the case of an excavation with a determined shape, waterproofing of the lift well (Fig. 7.6) is carried out as follows.

- To form a suitable laying surface and make application of the waterproofing system easier, the bottom of the excavation must be evened out by applying a layer of lean concrete about 10 cm thick.

- To lay the waterproofing system on the vertical surfaces, form a relatively even surface on which the **MAPEPROOF** is applied and fold the geo-textile over onto the laying surface of the foundation pad. Position the underside (the dark side) of the **MAPEPROOF** geo-textile polypropylene fabric on the substrate and overlap the edges of the sheets by at least 10 cm. Fasten the sheets in place with nails and **MAPEPROOF CD** polyethylene washers approximately every 30 cm.

- Spread **MAPEPROOF** on the horizontal surface and fasten it in place every 50 cm with nails and **MAPEPROOF CD** polyethylene washers. Avoid forming creases when laying the fabric on the lean concrete.

- In order to protect the sheets when positioning the steel reinforcement before pouring on the concrete for the lift well foundation pad, a 5-10 cm thick protective layer of the same concrete as used for the foundation pad may be required on the **MAPEPROOF**. This operation is not absolutely necessary because the bentonite sheets are able to resist damage from both the spacers and the steel reinforcement. Special plastic spacers must be used to keep the reinforcement cage for the lift well away from the sheets (if a protective layer has not



Fig. 7.4 – Waterproofing the base of a jib crane with MAPEPROOF bentonite sheets



Fig. 7.5a – One of the phases of waterproofing and casting a lift well: application of MAPEPROOF on the side walls of the excavation



Fig. 7.5b – Lift well lined with MAPEPROOF



Fig. 7.5c – Positioning the steel reinforcement



Fig. 7.5d – Casting the foundation pad for a lift well



Fig. 7.5e – Positioning wooden formwork before sealing construction joints between a foundation pad and the walls using IDROSTOP B25

been applied), which also help the concrete to flow under the steel reinforcement and guarantee that it is well covered.

- Pour in the concrete for the lift well foundation pad which must be calculated to withstand the in-service loads and the hydraulic lift from the groundwater.

- Once the concrete has cured correctly, seal the construction joints between the foundation pad and the vertical walls using **IDROSTOP B25** hydro-expanding, self-sealing bentonite jointing material with a section of 20x25 mm. Before applying **IDROSTOP B25**, carefully clean the surface to eliminate all traces of debris, and especially the slurry which bleeds from the surface, which usually forms when compacting the cementitious conglomerate.

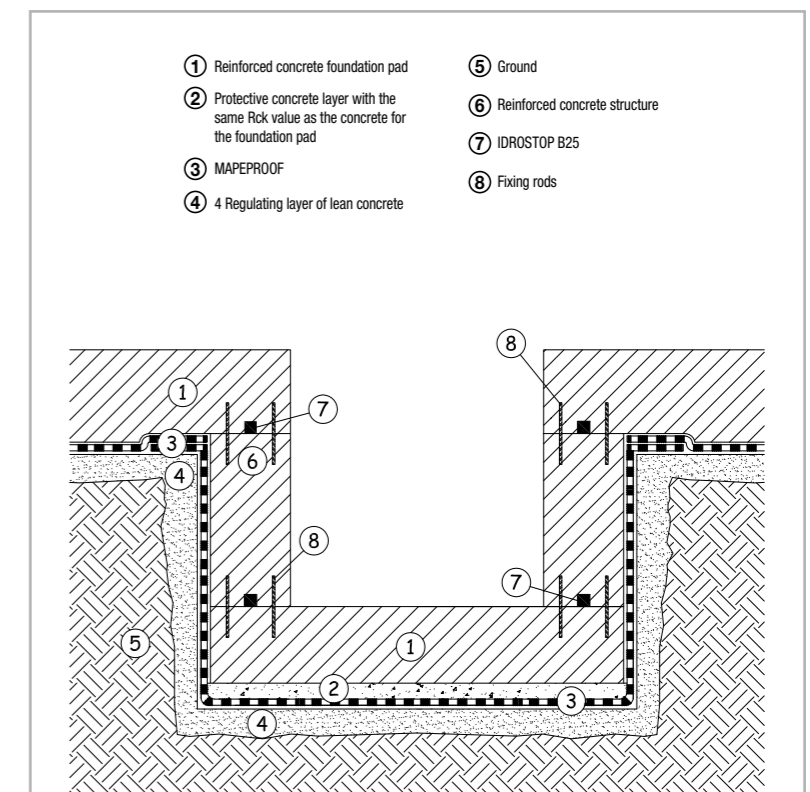

Fig. 7.6 – Detailed layout of waterproofing a lift well

WATERPROOFING STRUCTURES INSTALLED BELOW GROUND LEVEL

Then nail a rib (1 nail every 25 cm) along the middle of the vertical wall between the steel reinforcement. Join the ends together by simply laying the pieces alongside each other, and never on top of each other, for at least 6 cm.

- After installing the internal formwork, pour in the concrete to form the vertical walls of the lift well. To achieve the correct durability, it must be designed according to the specifications in Section 6.



Fig. 7.5f – Casting vertical walls

When creating a lift well by the stripping method (Fig. 7.7) the structure must be waterproofed as follows.

- To form a suitable laying surface and make application of the waterproofing system easier, the bottom of the excavation must be evened out by applying a layer of lean concrete about 10 cm thick.

- Install the outer formwork to cast the foundation pad. Then lay the **MAPEPROOF** with the polypropylene underside of the geo-textile polypropylene fabric (the dark side) on the sides of the formwork (Fig. 7.8) and then fold it over at least 20 cm onto the lean concrete. The upper side of the geo-textile fabric (the white side) will be turned towards the inside so it is visible.

- Overlap the edges of the sheets by at least 10 cm. Fasten the sheets in place with nails and **MAPEPROOF CD** polyethylene washers approximately every 30 cm. Avoid forming creases when laying the fabric on the formwork. When laying near to pipe-work which passes through the surface (see Section 7.9) the sheets must be cut to shape to suit the shape of such elements.

- Spread **MAPEPROOF** on the horizontal surface and fasten it in place every 50 cm with nails and **MAPEPROOF CD** polyethylene washers. Avoid forming creases when laying the fabric on the lean concrete. When laying near to elements which passes through the surface



Fig. 7.7 – Waterproofing a lift well built in a stripped-type excavation

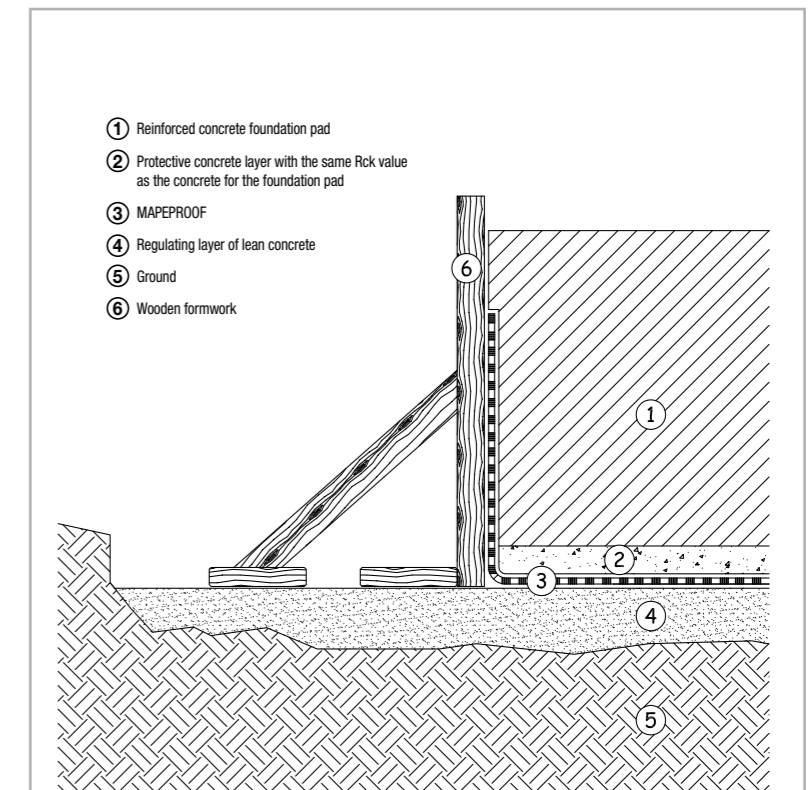

Fig. 7.8 – Detailed layout of MAPEPROOF applied on wooden formwork

(drains, pipe-work, etc.) the sheets must be cut to shape to suit the shape of such elements.

- In order to protect the sheets during normal site activities and while positioning the steel reinforcement for the poured concrete for the foundation pad, it may be necessary to cover the **MAPEPROOF** with a 5-10 cm thick layer of the same type of concrete as will be used for the foundations. (7.9). This operation is not absolutely necessary because the bentonite sheets are able to resist damage from both the spacers and the steel reinforcement. In this case, special plastic spacers must be used to keep the reinforcement cage for the lift well away from the **MAPEPROOF** sheets, which also help the concrete to flow under the steel reinforcement and guarantee that it is well covered.

WATERPROOFING STRUCTURES INSTALLED BELOW GROUND LEVEL

- Pour in the concrete for the lift well foundation pad which must be calculated to withstand the in-service loads and the hydraulic lift from the groundwater.

- Once the concrete has cured correctly, seal the construction joints between the foundation pad and the vertical walls using **IDROSTOP B25** hydro-expanding, self-sealing bentonite jointing material with a section of 20x25 mm. Before applying the **IDROSTOP B25**, carefully clean the surface and fasten the bentonite joint as described previously.

- Install the double formwork for the vertical concrete walls, and make sure that the first row of lower spacers is 5-10 cm from the **IDROSTOP B25**.

- Pour in the concrete for the walls of the lift well. Use concrete designed according to the specifications in Section 6.

- Once the walls have cured correctly, strip the formwork and waterproof the walls by applying **MAPEPROOF** (see Section 7.7.1). Seal the fillet joints between the foundation pad and the vertical walls using **IDROSTOP B25** hydro-expanding, self-sealing bentonite jointing material with a section of 20x25 mm.

- After completing the waterproofing operations of the lift well, lay the **MAPEPROOF** on the lean concrete as illustrated in the following Section. It is absolutely essential to guarantee that the **MAPEPROOF** sheets between the vertical walls and the horizontal sheets under the foundation pad are continuous, and overlap by at least 10 cm.

7.4 WATERPROOFING HORIZONTAL FOUNDATION PADS

To make application of the waterproofing system easier, the laying surface must be even with no bulges, large gaps and/or sharp protuberances so the system may be laid correctly. Even over the surface of the ground



Fig. 7.9 – One of the phases of casting the protective layer of concrete on MAPEPROOF, using concrete with the same Rck as that of the foundation pad



Fig. 7.10 – Nailing MAPEPROOF to wooden formwork



Fig. 7.12 – Laying MAPEPROOF using a metal lifting rig

with a layer of lean concrete with an average thickness of around 10 cm. We recommend forming the layer of lean concrete in a continuous, single layer.

In the case of excavations without confinement (see Section 4) apply the waterproofing system as indicated below:

- Install the outer formwork to cast the foundation pad. Then lay the **MAPEPROOF** with the underside (the dark side) of the geo-textile polypropylene fabric on the inner sides of the formwork (Fig. 7.7 and Fig. 7.10) and then fold it over by 20 cm onto the lean concrete. The upper side of the geo-textile fabric (the white side) will be turned towards the inside so it is visible. The edges of the sheets must overlap by at least 10 cm. Fasten the sheets in place with nails and **MAPEPROOF CD** polyethylene washers approximately every 30 cm.

In the case of excavations without confinement (see Section 4) apply the waterproofing system as indicated below:

- lay the rolls of **MAPEPROOF** by positioning the underside (the dark side) of the geo-textile polypropylene fabric on the surface of the lean concrete and the upper side of the fabric (the white side) facing upwards so it is visible. The edges must overlap by at least 10 cm. Fasten the sheets in place on the substrate with nails and **MAPEPROOF CD** polyethylene washers approximately every 50 cm.

- Apply **MAPEPROOF** in the lower part of the containment bulkheads of the excavation, and fold a strip at least 20 cm wide on the lean concrete. The underside of the geo-textile polypropylene fabric (the dark side) must be placed on the substrate and the upper side of the geo-textile fabric (the white side) must face upwards so it is visible.

After laying the geo-textile fabric on the formwork or the lower part of

WATERPROOFING STRUCTURES INSTALLED BELOW GROUND LEVEL

the bulkheads, lay the rolls of **MAPEPROOF** on the lean concrete as described below.

- Lay (Fig. 7.12) the rolls of **MAPEPROOF** by positioning the underside (the dark side) of the geo-textile polypropylene fabric on the surface of the lean concrete and the upper side of the fabric (the white side) facing upwards so it is visible. The edges must overlap by at least 10 cm. Fasten the sheets in place on the substrate with nails and **MAPEPROOF CD** polyethylene washers approximately every 50 cm.

- In order to protect the sheets during normal site activities and while positioning the steel reinforcement for the poured concrete for the foundation pad, it may be necessary to cover the **MAPEPROOF** with a 5-10 cm thick layer of the same type of concrete as will be used for the foundations. This operation is not absolutely necessary because the bentonite sheets are able to resist damage from both the spacers and the steel reinforcement. In this case, the steel reinforcement must be positioned at a certain distance from the **MAPEPROOF** using special plastic spacers (Fig. 7.13) which also help the concrete to flow under the steel reinforcement and guarantee that it is well covered.

- Position the steel reinforcement and pour in the concrete for the foundation pad, calculated to withstand the in-service loads and the hydraulic lift of the groundwater. Use concrete designed with durability characteristics according to the specifications in Section 6.

7.5 WATERPROOFING PILE HEADS

Designers often have to design foundation structures on ground with poor load-bearing capacity, and are therefore obliged to use deep foundation systems such as reinforced concrete piles. The piles work in conjunction with the foundation pad to comply with the requirements of the project. When waterproofing a foundation pad resting on piles, it is necessary to differentiate between two different application methods. The difference

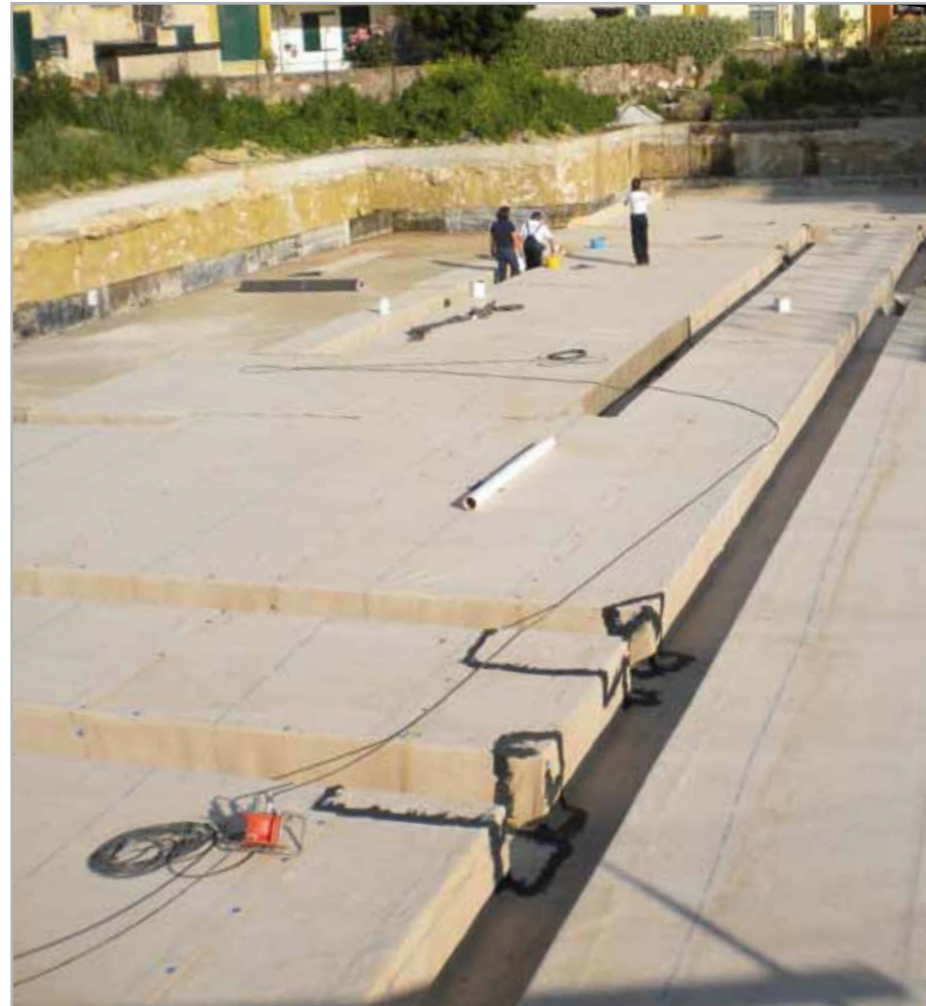

Fig. 7.11 – Waterproofing a ribbed foundation pad by applying MAPEPROOF



Fig. 7.13 – Metallic reinforcement positioned on MAPEPROOF and separated from the sheets with spacers

lies in the way the **MAPEPROOF** is laid, in that it may have the heads of the piles passing through it.

In the case of the heads of the piles passing through the bentonite sheets (Fig. 7.14) apply the waterproofing system as indicated below:

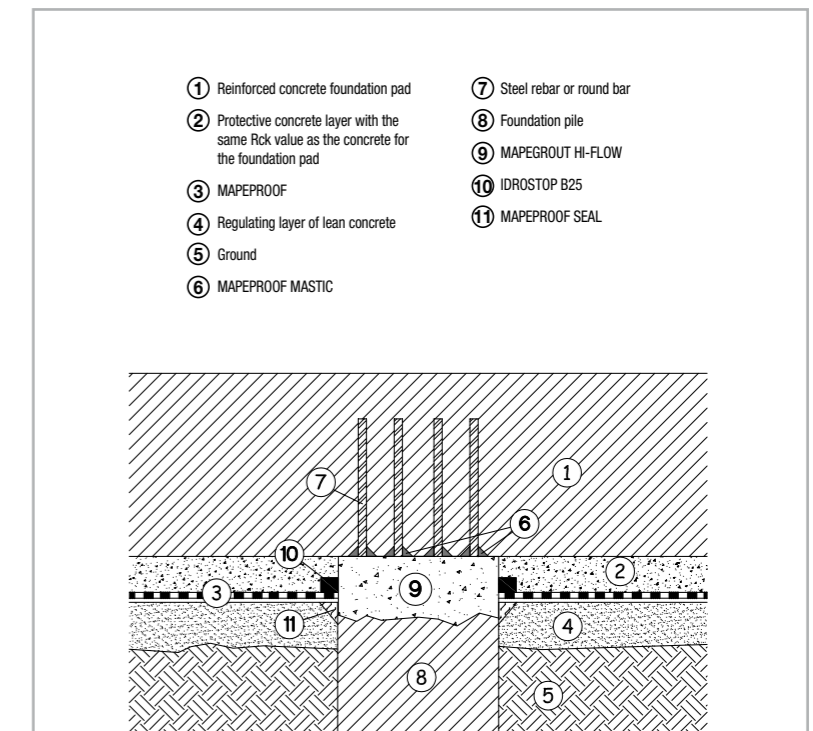

Fig. 7.14 – Detailed layout of waterproofing the heads of piles which work together with the foundation pad and pass through the bentonite sheet

- crop the head of the pile until the scarified surface is at least 10 cm below the level of the outer face of the lean concrete.

The pile should be cropped (Fig. 7.15) by scarifying with a lightweight pneumatic hammer to leave a rough surface. Carefully clean the scarified surface using high-pressure water jets (120-180 atm) to completely remove all traces of dust or any other type of material which could compromise the bond of the successive layer of repair mortar.

- Position a cylindrical metal mould (Fig. 7.16) 15 cm high with a width suitable for the section of the pile. Then, to guarantee a monolithic bond between the head of the pile and the new repair mortar, we recommend applying **EPORIP** solvent-free, two-component epoxy adhesive on the surfaces.

WATERPROOFING STRUCTURES INSTALLED BELOW GROUND LEVEL

Apply **EPORIP** on the substrate, which should be dry or only slightly damp, making sure it penetrates into the particularly rough and porous areas to guarantee a perfect bond over the whole surface;

- Pour (Fig. 7.17-18) **MAPEGROUT HI-FLOW** controlled-shrinkage, fibre-reinforced mortar for repairing concrete with 30% of gravel with a grain size between 5 and 8-10 mm and 0.25% **MAPECURE SRA** curing compound to reduce hygrometric and plastic shrinkage into the mould while the **EPORIP** is still fresh. **MAPEGROUT HI-FLOW** guarantees both a perfect watertight joint and high compressive strength at the head of the pile.

- After removing the mould, the perimeter of the head of the pile will need to be sealed (Fig. 7.19) by inserting 300 g per metre of powdered **MAPEPROOF SEAL**.

- Lay on the **MAPEPROOF** and cut the sheets to shape around the heads of the piles (Fig. 7.20) positioning the underside of the geo-textile polypropylene fabric (the dark side) on the lean concrete. The edges of the sheets must overlap by at least 10 cm. Fasten the sheets to the substrate with nails and **MAPEPROOF CD** polyethylene washers approximately every 50 cm. Take care when unrolling the fabric to avoid forming creases when laying the fabric on the lean concrete.

- Around the heads of the piles, nail the **IDROSTOP B25** in position (Fig. 7.21) hydro-expanding, self-sealing bentonite with a section of 20x25 cm. Join the ends by simply laying them alongside for at least 6 cm.

- Finish off the waterproofing system by grouting all the steel reinforcement in the heads of the piles by trowelling around each rod with **MAPEPROOF MASTIC** natural sodium bentonite grout with plasticising additives (Fig. 7.22).



Fig. 7.13 - Metallic reinforcement positioned on MAPEPROOF and separated from the sheets with spacers



Fig. 7.15 - Cropping the head of a pile



Fig. 7.17 - The head of a pile rebuilt with MAPEGROUT HI-FLOW



Fig. 7.16 - Metallic cylindrical mould in place before casting MAPEGROUT HI-FLOW



Fig. 7.18 - An overall view of a series of piles during the rebuilding of the heads

If the heads of the piles do not pass through the bentonite sheets (Fig. 7.23) apply the waterproofing system as indicated below:

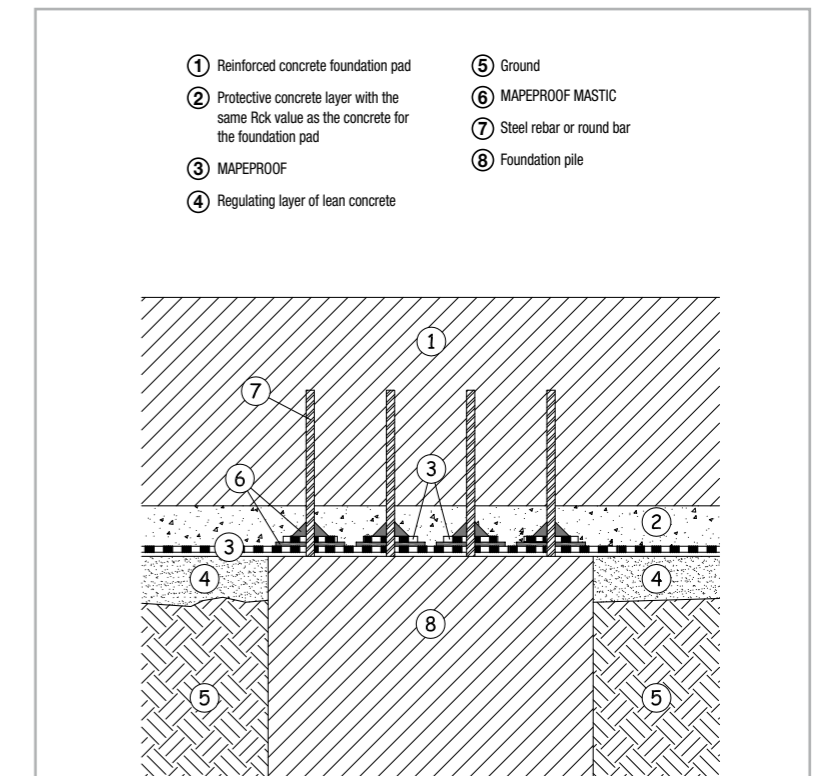

Fig. 7.23 - Detailed layout of waterproofing the heads of piles which work together with the foundation pad without passing through the bentonite sheet

- Lay on the **MAPEPROOF** and make holes in it to allow the reinforcement rods in the head of the piles to pass through (Fig. 7.24) and position the underside (the dark side) of the geo-textile polypropylene fabric on the surface of the lean concrete with the upper side of the fabric (the white side) facing upwards so it is visible. The edges must overlap by at least 10 cm. Fasten the sheets in place on the substrate with nails and **MAPEPROOF CD** polyethylene washers approximately every 50 cm.

- After grouting all the reinforcement rods with **MAPEPROOF MASTIC** apply a piece of bentonite sheet over each rod.

The fillet between the pieces of sheet and the reinforcement rods must also be grouted with **MAPEPROOF MASTIC** (Fig. 7.25-27).

WATERPROOFING STRUCTURES INSTALLED BELOW GROUND LEVEL

To waterproof the foundation pad, the technique used to lay the bentonite sheets is the same as described in Section 7.4.

In order to protect the **MAPEPROOF** from being damaged during normal site activities and while positioning the steel reinforcement for the poured concrete for the foundation pad, it may be necessary to cover the sheets with a 5-10 cm thick layer of the same type of concrete as will be used for the foundations. This operation is not absolutely necessary because the bentonite sheets are able to resist damage from both the spacers and the steel reinforcement. In this case, special plastic spacers must be used to keep the steel reinforcement away from the **MAPEPROOF** sheets, which also help the concrete to flow under the steel reinforcement and guarantee that it is well covered.

After positioning the steel reinforcement, pour on the concrete for the foundation pad according to the specifications for the concrete in Section 6. If the concrete needs to be poured in different steps, the joints between each cast must be sealed (Fig. 7.28-29) using **IDROSTOP B25** hydro-expanding bentonite jointing material with a section of 20x25 mm made from natural sodium bentonite and polymers. The rib must be fastened on the foundation pad at the mid-point of the perimeter walls with nails (1 nail every 25 cm). The ends are joined by simply laying them alongside each other (and never by overlapping) for at least 6 cm. The **IDROSTOP B25** used to seal the construction joints in the foundation pad and to seal the construction joints in the vertical walls must also be joined together by laying the strips alongside each other (Fig. 7.30).

After completing casting of the foundation pad, there will be one of two situations: if the excavation is confined, the waterproofing system may be laid on the vertical surfaces before casting (Section 7.6). If the excavation is not confined, the vertical concrete walls may be cast before waterproofing them (Section 7.7).



Fig. 7.19 - Sealing around the perimeter of the head of a pile with MAPEPROOF SEAL



Fig. 7.22 - Grouting the reinforcement in a pile with MAPEPROOF MASTIC



Fig. 7.20 - MAPEPROOF cut to shape around the head of a pile



Fig. 7.24 - MAPEPROOF with the steel reinforcement of a pile passing through it



Fig. 7.21 - Application of IDROSTOP B25 around the head of a pile



Fig. 7.25 - Localised reinforcement of the waterproofing with a piece of MAPEPROOF grouted with MAPEPROOF MASTIC

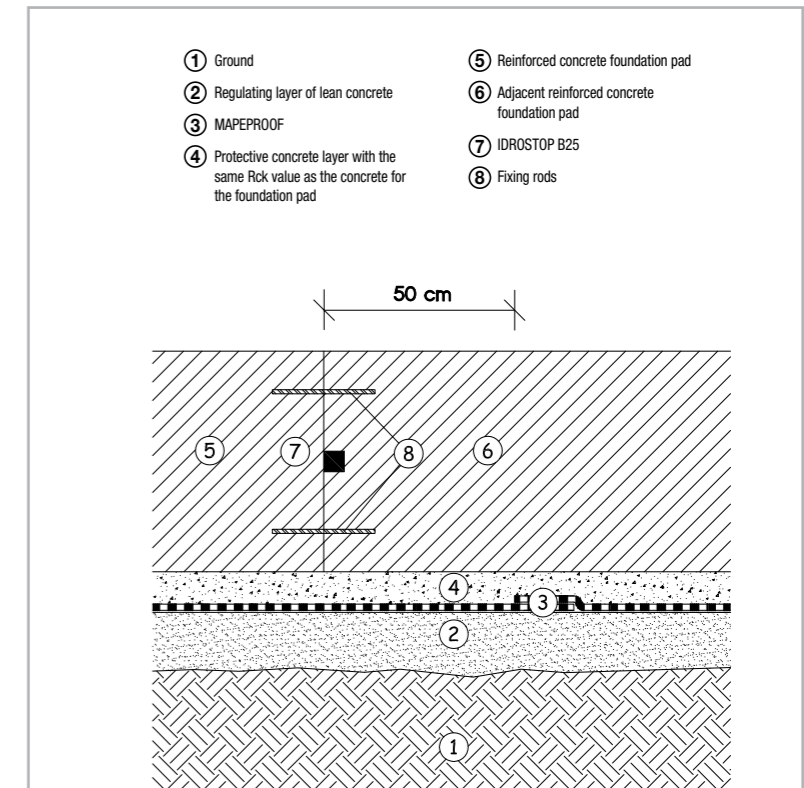

Fig. 7.28 - Detailed layout of sealing a construction joint on a foundation pad

7.6 WATERPROOFING VERTICAL SURFACES BEFORE CASTING

The laying of **MAPEPROOF** on the containment bulkheads of the side walls of excavations may be divided into four different cases, according to the type of structural element used to confine the excavation: sheetpiling, piles, micro-piles and diaphragms.

Sheetpiling

MAPEPROOF may be applied directly on sheetpiling if the sheetpiling does not have to be recovered after construction, or on OSB (Oriented Strand Board) attached to the sheetpiling (Fig. 7.31).

Bentonite sheets may be cut to shape so they may be laid directly on the sheetpiling and perfectly adapt to its shape. The first operation to carry out is to clean the entire surface with high pressure water jets (150-180

WATERPROOFING STRUCTURES INSTALLED BELOW GROUND LEVEL

atm) to eliminate loose parts. The **MAPEPROOF** is then applied, starting from the top and unrolling the rolls of geo-textile fabric with the underside (the darker side) against the sheetpiling, with an overlap of at least 10 cm between each sheet. The sheets are then fixed to the substrate with nails inserted with a nail gun approximately every 30 cm. This solution avoids the overlaps opening up under the weight of the concrete which could occur when it is poured. If the sheetpiling needs to be recovered when construction work has been completed, OSB (Oriented Strand Board) panels must be placed against the sheetpiling. This solution may be adopted even if just a flat laying surface needs to be prepared to guarantee a suitable support so the bentonite sheets may be fixed to the panels using a dense series of staples. Before casting the concrete walls, the gaps between the OSB panels and the sheetpiling must be filled with sand to make sure the panels have a solid support along the entire stretch.

The techniques used to lay **MAPEPROOF** on piles, micro-piles and diaphragms are very similar to each other, but each technique will be described separately to highlight their differences.

Piles

If particularly large piles are used, the bentonite sheets may be laid directly on the piles themselves (Fig. 7.32) as previously illustrated when laying **MAPEPROOF** on sheetpiling. A valid alternative is to apply **MAPEPROOF** on OSB panels (Fig. 7.33-34) placed against the piles, like the system used for sheetpiling. If small piles are inserted, first of all the surface must be cleaned with high pressure water jets, followed by levelling off the laying surface and the heads of the tie-rods (if present) with **MAPEGROUT T60** sulphate-resistant, fibre-reinforced thixotropic mortar mixed with 025% of **MAPECURE SRA** curing agent to reduce hygrometric and plastic shrinkage.

Once the concrete has hardened, apply pieces of **MAPEPROOF** on the heads of the tie-rods to locally reinforce the waterproofing layer. Then



Fig. 7.26 – A piece of sheet nailed to the substrate



Fig. 7.27 – An overall view of the waterproofing layer on the head of a series of piles



Fig. 7.29 – Sealing a construction joint on a foundation pad with IDROSTOP B25. The protective PE sheet on the strip of MAPEPROOF may be seen protruding from the foundation, which is then overlapped with the adjacent sheet laid before casting the next layer of concrete

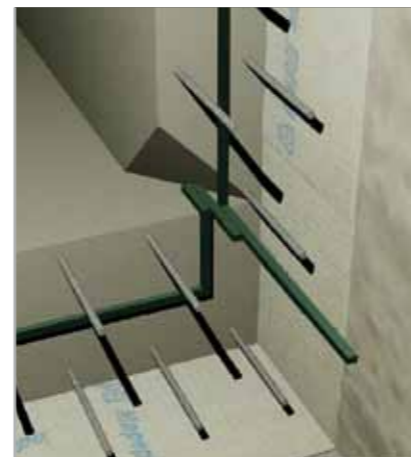

Fig. 7.30 – Strips of IDROSTOP B25 used to seal construction joints in the foundation pad alongside a strip used to seal construction joints between the foundation pad and the walls and between the walls

apply waterproofing sheets on all the vertical surfaces, starting from the top. Overlap the sheets by at least 10 cm and fasten them in place with

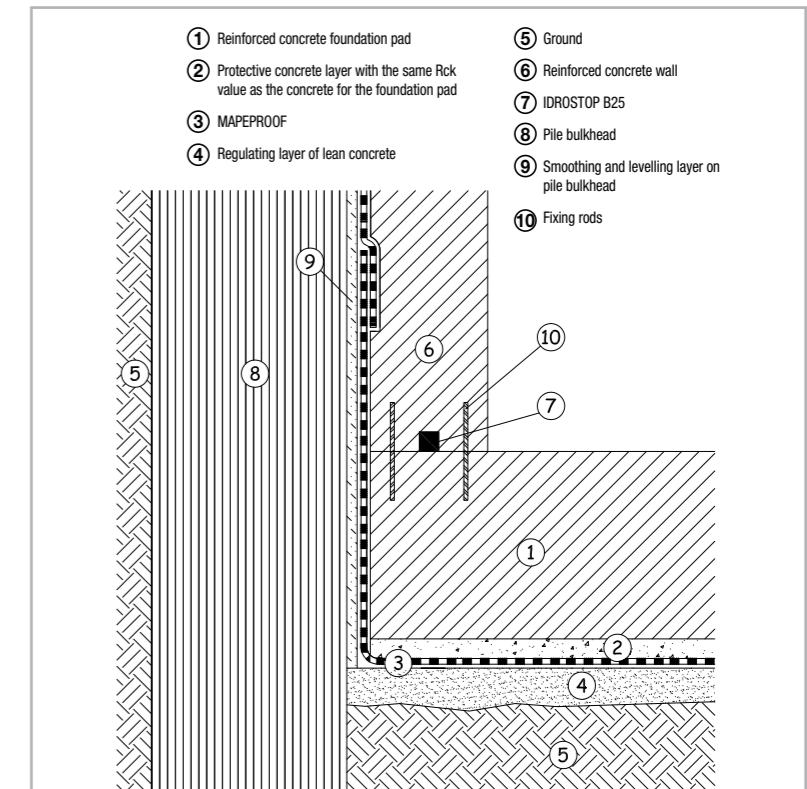

Fig. 7.34 – Detailed layout of applying Mapeproof against a pile bulwark with a surface which has been levelled off

nails and **MAPEPROOF CD** polypropylene washers approximately every 30 cm. The topping beam on the bulkhead must also be waterproofed. Clean the surfaces with high pressure water jets (180-300 atm) and then smooth off the surface with **PLANITOP 400** quick-setting, compensated-shrinkage, thixotropic mortar for quick repairs on the surface of concrete, or with **PLANITOP 430** fine-grained, fibre-reinforced, compensated-shrinkage thixotropic mortar for repairing deteriorated concrete or products from the **MAPEGROUT** range. Once the surface has been smoothed off, apply two coats of **MAPELASTIC FOUNDATION** with a brush, a roller or by spray to form a layer at least 2 mm thick. Approximately 4 hours after applying the first layer in good weather, and in all cases only when the first layer has dried, the second layer may be applied. **MAPELASTIC FOUNDATION**

WATERPROOFING STRUCTURES INSTALLED BELOW GROUND LEVEL

must be applied on all the front face of the topping beam (Fig. 7.35), on the inner face of the beam and on the upper part of the bulkhead, and then overlap it by at least 30 cm with **MAPEPROOF** to completely seal the waterproofing system. The fillet joint between **MAPEPROOF** and **MAPELASTIC FOUNDATION** must be sealed by applying **IDROSTOP B25**.

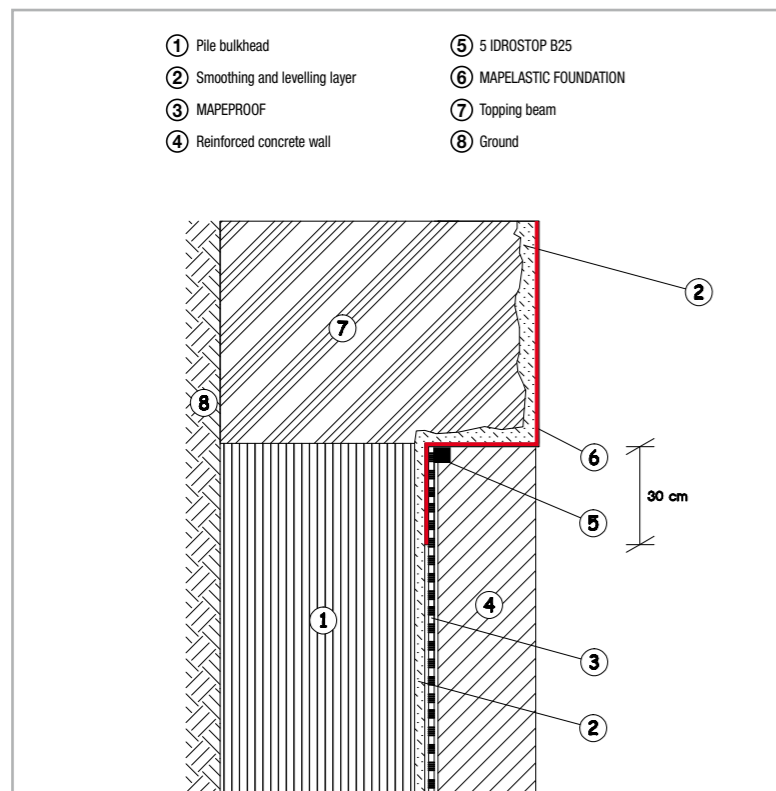

Fig. 7.35 – Waterproofing the topping beam on a bulkhead

Micro-piles

Bulkheads made from micro-piles have an uneven surface and so a flat laying surface suitable for applying **MAPEPROOF** must be created. As an alternative, a suitable means of support to fix the vertical overlaps of the bentonite sheets in place may be used. There are three main steps to apply the waterproofing system:

- lay a continuous row of OSB (Oriented Strand Board) panels against the micro-piles;



Fig. 7.31 – MAPEPROOF applied directly on sheetpiling



Fig. 7.32 – MAPEPROOF applied directly on a pile bulkhead



Fig. 7.33 – Application of MAPEPROOF on OSB panels laid against piles

- clean the surface with water jets and even out the surface (Fig. 7.36) by applying **MAPEGROUT T60** sulphate-resistant, fibre-reinforced thixotropic mortar mixed with 0.25% of **MAPECURE SRA**;

- fasten planks of wood to the micro-piles at a pitch equal to the width of the bentonite sheets to fix the vertical overlaps of the **MAPEPROOF** in place.

After carrying out the above operations, lay the **MAPEPROOF** starting from the top and overlap the sheets by at least 10 cm. Fix the sheets in place with nails and **MAPEPROOF CD** polyethylene washers approximately every 30 cm.

Diaphragms

The surface of diaphragms is smooth enough to lay **MAPEPROOF** sheets directly (Fig. 7.37-39). The laying procedure is identical to the procedure used for sheetpiling, so the first operation to carry out is to clean the surface with high pressure water jets (150-180 atm) to eliminate loose parts. Level off the heads of the tie-rods (if present) with **MAPEGROUT T60** sulphate-resistant, fibre-reinforced thixotropic mortar mixed with 0.25% of **MAPECURE SRA** curing agent which reduces hygrometric and plastic shrinkage.

Once the mortar has hardened, apply pieces of bentonite sheet on the heads of the tie-rods to locally reinforce the waterproofing layer. Then lay the **MAPEPROOF** starting from the top with the underside (the dark side) of the geo-textile fabric on the substrate, overlapping the sheets by at least 10 cm. Fix the sheets in place with nails approximately every 30 cm. This solution avoids the overlaps opening up under the weight of the concrete which could occur when it is poured. If seeping water is present, including water under pressure, before laying the **MAPEPROOF** seal the leaks by applying **LAMPOSILEX** ultra quick-hardening hydraulic binder manually, a product used to block infiltrations of water.

WATERPROOFING STRUCTURES INSTALLED BELOW GROUND LEVEL

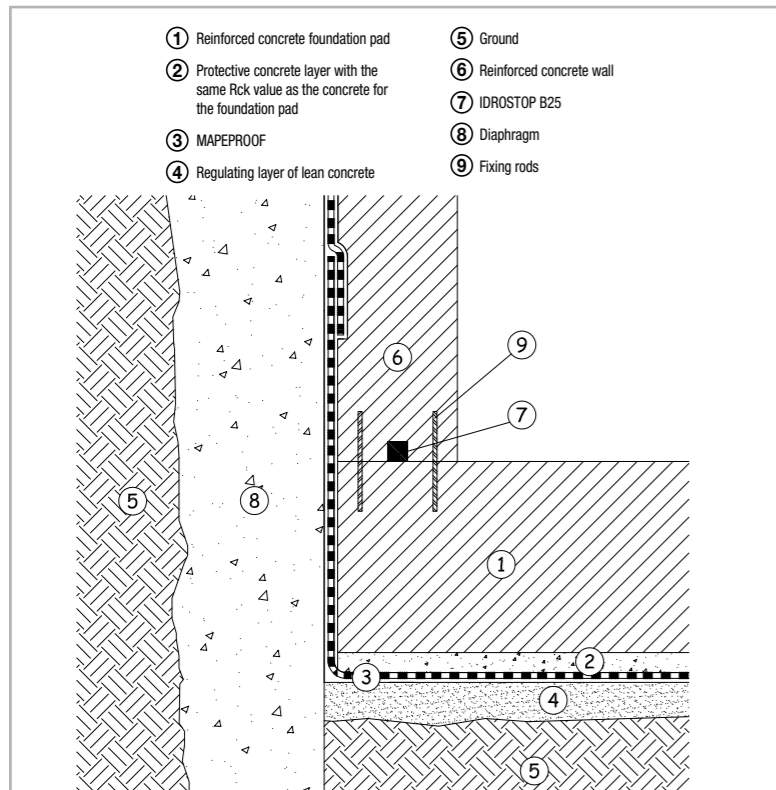

Fig. 7.39 – Detailed layout of applying MAPEPROOF against a diaphragm

In all four examples described above, the bentonite sheets applied vertically must overlap the sheet laid before casting the foundation pad. This will guarantee structural continuity between the horizontal and vertical waterproofing layers.

In certain cases, to reduce the thickness of the reinforced concrete structures to be built, insert reinforcement connectors between the bulkhead and the structure to be cast to form a static union between the two structural elements (Fig. 7.40). In correspondence with the reinforcement connectors, holes must be made in the MAPEPROOF for the connectors pass through. After laying the MAPEPROOF, they must be sealed in three steps as follows: grout the connectors with MAPEPROOF MASTIC natural sodium bentonite grout with plasticising agents; apply pieces of bentonite sheet and nail them in place; grout the fillet around the tie-rod with MAPEPROOF MASTIC.



Fig. 7.36 – Bulkhead in micro-piles levelled off with MAPEGROUT T60



Fig. 7.37 - Laying MAPEPROOF against a diaphragm

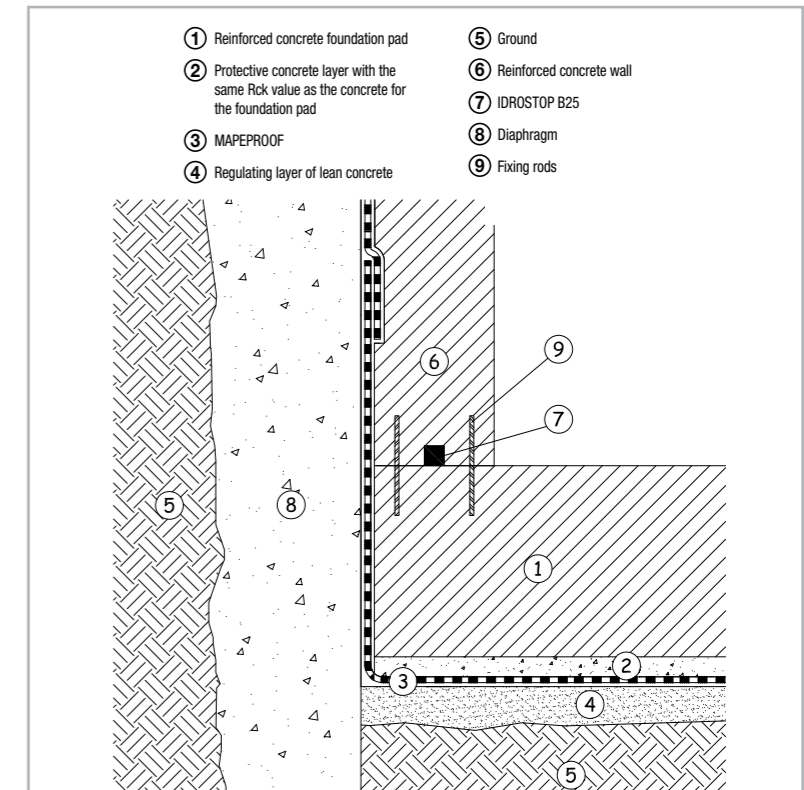

Fig. 7.40 – Detailed layout of applying MAPEPROOF against a diaphragm which works together with the structure

After applying the MAPEPROOF, seal the construction joints between the foundation pad and the reinforced concrete vertical walls with IDROSTOP B25 hydro-expanding bentonite joint, nailed in place every 25 cm at the mid-point of the section of the vertical walls between the steel reinforcement rods.

Before applying IDROSTOP B25, carefully clean the surface to eliminate all traces of debris, and especially the slurry which usually bleeds from the surface when compacting the cementitious conglomerate. Then seal the formwork and cast the vertical reinforced concrete walls with reinforced concrete according to the specifications in Section 6. The sealing operation with IDROSTOP B25 must be repeated for each construction joint in the vertical walls, making sure that the rib laid vertically between the walls is laid alongside the rib on the horizontal surface for at least 6 cm (Fig. 7.41).

7.7 WATERPROOFING VERTICAL SURFACES AFTER CASTING

As previously discussed, if an excavation has no confinement, it is possible to operate on the external side of the vertical walls and install the waterproofing system after casting. In these cases, after casting the foundation pad and once the foundation pad has cured, seal the construction joints between the foundation pad and the reinforced concrete vertical walls with **IDROSTOP B25** hydro-expanding bentonite joint, nailed in place every 25 cm at the mid-point of the section of the vertical walls between the steel reinforcement rods. Before applying **IDROSTOP B25**, carefully clean the surface to eliminate all traces of debris, and especially the slurry which usually bleeds from the surface when compacting the cementitious conglomerate. Then seal the formwork and cast the vertical reinforced concrete walls with reinforced concrete according to the specifications in Section 6). The sealing operation with **IDROSTOP B25** must be repeated for each construction joint in the vertical walls, making sure that the rib laid vertically between the walls is laid alongside the rib on the horizontal surface for at least 6 cm. As an alternative to **IDROSTOP B25**, **IDROSTOP** may be applied as previously illustrated in Section 7.1. MAPEI offers a wide range of technical solutions and products for waterproofing vertical surfaces after casting, which will be described below.

Continuity between waterproofing layers applied before casting (foundation pad) and after casting (walls) is guaranteed by overlapping the sheets by 10 cm, and on vertical surfaces **MAPEPROOF** or **MAPEPROOF LW** is also used. If the waterproofing layer applied on vertical surfaces after casting is made using **MAPELASTIC FOUNDATION** or with a product from the **PLASTIMUL** range, they must be applied in such a way that they join to the **MAPEPROOF** applied before casting. Therefore, to guarantee continuity in the waterproofing layer, apply a strip of **MAPEPROOF** starting from the wall-foundation pad fillet joint, grouted with **MAPEPROOF MASTIC**, until it overlaps the waterproofing layer applied before casting by at least 10 cm.



Fig. 7.38 – Application of MAPEPROOF on the lower part of diaphragms

7.7.1 WATERPROOFING VERTICAL SURFACES AFTER CASTING WITH MAPEPROOF OR MAPEPROOF LW

The **MAPEPROOF** and **MAPEPROOF LW** sheets may also be applied after casting (Fig. 7.42). Before applying the **MAPEPROOF** the spacers must be either removed or sealed (Fig. 7.43-44) according to whether the spacers are metallic (for wooden formwork) or plastic (for metallic formwork). Then eliminate all irregularities in the substrates and smooth over gravel clusters in the surface with **MAPEGROUT FAST-SET** fibre-reinforced, controlled-shrinkage, quick setting and hardening mortar for repairing concrete or **PLANITOP 400** quick-setting, controlled-shrinkage thixotropic mortar for repairing the surface of concrete.

In the vicinity of the 90° joint between the wall and the foundation pad, we recommend forming a bead to support the fillet between the horizontal and vertical surfaces using **MAPEGROUT FAST-SET** or **PLANITOP 400**, or with mortar made using sand and cement with **PLANICRETE** synthetic latex rubber admix for cementitious mixes at a ratio of 1 to 3.

A strip at least 50 cm wide at the top of the wall must be waterproofed with **MAPELASTIC FOUNDATION** applied in two coats to form a layer at least 2 mm thick. Then lay the **MAPEPROOF** starting from the top, making sure that it overlaps the **MAPELASTIC FOUNDATION** by at least 20 cm.

In the fillet between the two systems, apply **MAPEPROOF MASTIC** on top of the **MAPELASTIC FOUNDATION**. Fasten the sheets in place with nails and **MAPEPROOF CD** polyethylene washers approximately every 30 cm. When applied after casting (Fig. 7.45), the bentonite sheets are laid with the upper side of the geo-textile fabric (the white side) against the reinforced concrete wall, while the underside of the geo-textile fabric (the darker side) faces the outside, that is, in contact with the ground. Please note that the white non-woven fabric of **MAPEPROOF** must always be laid in contact with the surface to be waterproofed. When laying near to pipe-work which passes through the surface, the sheets must be cut to shape to suit the shape of such elements, which must then be sealed as described in Section 7.9.

WATERPROOFING STRUCTURES INSTALLED BELOW GROUND LEVEL

After laying the **MAPEPROOF**, lay 250 g/m² non-woven fabric to protect the waterproofing layer when filling in excavations. Fill with homogenous fine and mixed loose earth in well-compacted layers 40 to 50 cm thick, to guarantee that, once the filling operations have been completed, there are no gaps or voids and there is better confinement of the system.

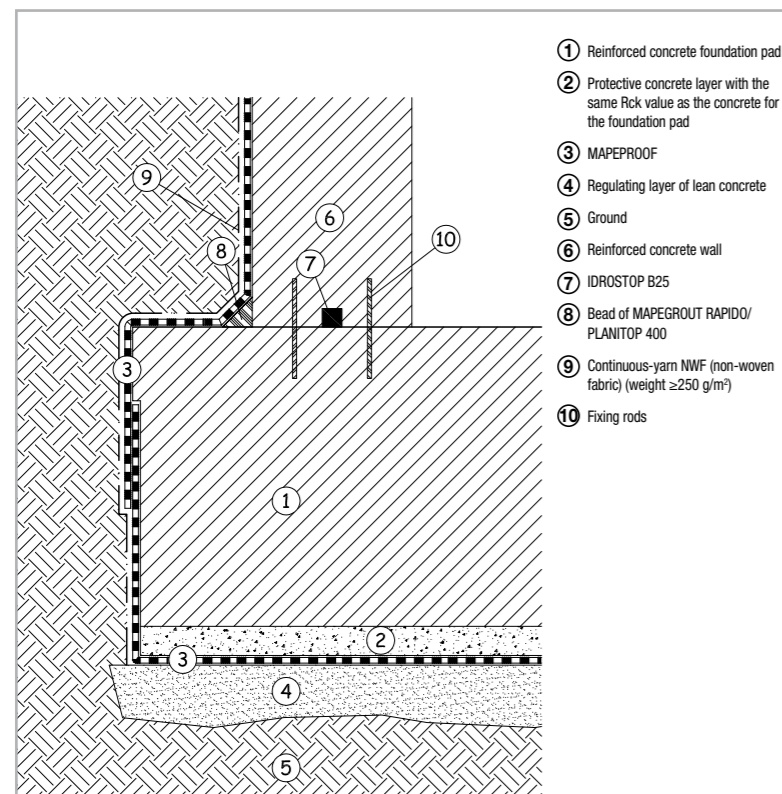

FIG. 7.42 – DETAILED LAYOUT OF WATERPROOFING AFTER CASTING WITH MAPEPROOF

7.7.2 WATERPROOFING VERTICAL SURFACES AFTER CASTING WITH MAPELASTIC FOUNDATION

MAPELASTIC FOUNDATION is a two-component, flexible cementitious mortar specifically for waterproofing concrete surfaces subject to positive hydraulic lift (Fig. 7.46) and negative hydraulic lift (up to 1.5 atm, equal to a 15 m head of water). The surfaces to be treated must be clean and free of stripping compound, grease and all traces of dirt or any other material which could potentially compromise the bond of the waterproofing material. The surfaces, therefore, must be thoroughly cleaned by dry

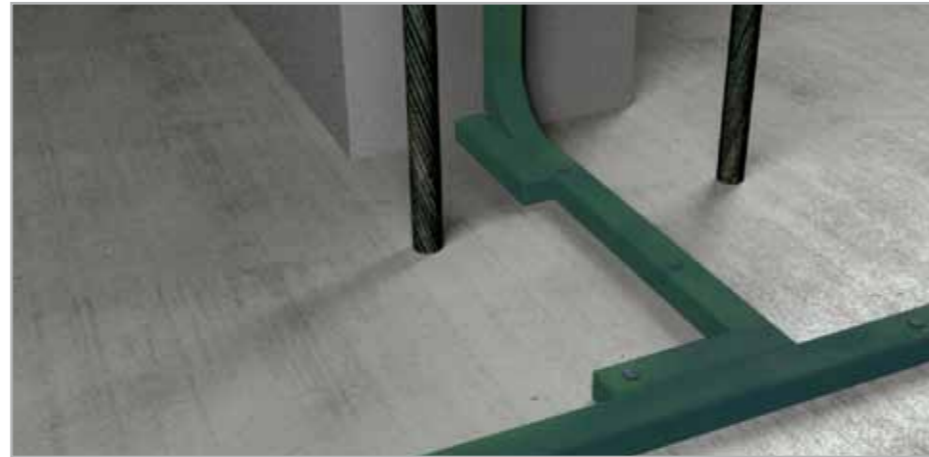

Fig. 7.41 – Strips of IDROSTOP B25 used to seal construction joints between a foundation pad and the walls and construction joints between adjacent walls



Fig. 7.43 – The blades of the formwork sticking through a reinforced concrete wall before being removed



Fig. 7.44 – Levelling off the concrete surface after removing the blades of the formwork

sandblasting at a controlled pressure or with high pressure water jets (150-180 atm).

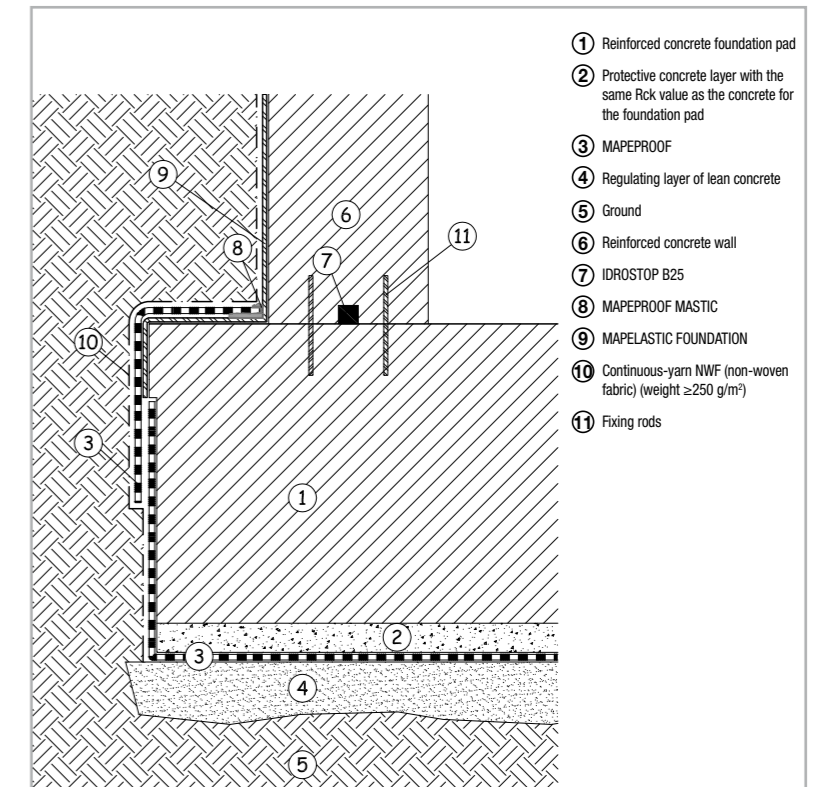

Fig. 7.46 – Detailed layout of waterproofing a foundation pad with MAPEPROOF and MAPELASTIC FOUNDATION applied on the wall

Eliminate all irregularities in the substrates and smooth over gravel clusters with **MAPEGROUT FAST-SET** fibre-reinforced, controlled-shrinkage, quick setting and hardening mortar for repairing concrete or **PLANITOP 400** quick-setting, controlled-shrinkage thixotropic mortar for repairing the surface of concrete.

MAPELASTIC FOUNDATION must be applied by brush (Fig. 7.48), with a roller or by spray to form a coat at least 2 mm thick. Approximately 4 hours after applying the first layer in good weather, and in all cases only when the first layer has dried, the second layer may be applied. Apply **MAPEBAND TPE** (Thermoplastic Elastomer) high-flexibility, waterproof tape in correspondence with the structural joints, a product recommended for flexible sealing and waterproofing of expansion joints up to 10 mm wide

WATERPROOFING STRUCTURES INSTALLED BELOW GROUND LEVEL

subject to movement. The tape is 1 mm thick with edges reinforced with polyester fabric, and must be bonded in place with **ADESILEX PG4** two-component, thixotropic epoxy adhesive as follows (Fig. 7.48):

- apply an even 1-2 mm thick layer of **ADESILEX PG4** with a smooth trowel on the clean, dry substrate. Try to avoid the adhesive running into the joint. Lay the **MAPEBAND TPE** by pressing along the sides, making sure there are no creases or air bubbles.

- Apply a second layer of **ADESILEX PG4** fresh on fresh, and completely cover the sides of the tape with the second layer. Smooth over with a flat trowel and, while the product is still fresh, sprinkle on a layer of 0.5 spheroid quartz to form a rough layer to help the **MAPELASTIC FOUNDATION** form a good bond.

- Once the reticulation process of the **ADESILEX PG4** has been completed, remove any loose quartz and lay the **MAPELASTIC FOUNDATION**. When the mortar has hardened, apply a layer of 250g/m² non-woven fabric to protect the waterproofing system when filling in (Fig. 7.49).

7.7.3 WATERPROOFING VERTICAL SURFACES AFTER CASTING WITH PRODUCTS FROM THE PLASTIMUL RANGE

Vertical surfaces may be waterproofed after casting with products from the **PLASTIMUL** range, bituminous emulsion waterproofing products with different technical properties and final performance characteristics.

Before applying one of the products from the **PLASTIMUL** range, the surface to be treated must be clean and free of all traces of dirt or any other material which could potentially compromise the bond of the waterproofing material. Concrete surfaces must also be free of all rough edges and honeycombs. Seal cracks and imperfections in the substrate with **PLANITOP 400** quick-setting, compensated-shrinkage thixotropic mortar used for repairing the surface of concrete, or with products from the **MAPEGROUT** range.



Fig. 7.45A – Nailing MAPEPROOF to the substrate after casting



Fig. 7.45b – A vertical wall waterproofed with MAPEPROOF after casting



Fig. 7.47 – Application of MAPELASTIC FOUNDATION with a brush on the upper part of a wall before applying MAPEPROOF



Fig. 7.48a – Phases of waterproofing an expansion joint subject to movements of up to 10 mm with MAPEBAND TPE: to avoid the epoxy adhesive leaving a rough edge, apply masking tape along the sides of the joint

PLASTIMUL is a solvent-free bitumen emulsion which may be used to protect rendered, brickwork structures or concrete structures against rising damp from the ground or accumulated water. The surfaces to be treated must be dampened before applying two layers of **PLASTIMUL** as follows:

- first layer (primer). Dilute **PLASTIMUL** with approximately 45-50% of water and mix until completely blended. Apply the solution with a brush. When it is completely dry, which normally requires 3-6 hours according to the surrounding temperature and the ventilation, apply the second layer.

- Second layer. Apply a 1 mm thick coat of neat **PLASTIMUL** with a trowel (Fig. 7.50) or with a flat brush. Once completely dry, **PLASTIMUL** forms a waterproof plastic dressing coat which is resistant to re-emulsification after long periods of immersion in water, including water which is slightly acidic or alkaline, and which is also resistant to aggressive agents in the ground.

PLASTIMUL 1K SUPER PLUS is a one-component, solvent-free, quick-drying, low-shrinkage, high-yield, high-flexibility bitumen waterproofing emulsion containing polystyrene beads and rubber granules. The polystyrene beads guarantee the minimum thickness while the rubber increases the product's flexibility. Thanks to these components, the product is easy to apply with a flat or notched trowel or by spray with a peristaltic pump. **PLASTIMUL 1K SUPER PLUS** is resistant to the alkalis in the concrete and aggressive substances usually found in the ground. It is used to form a thick bitumen waterproofing layer on horizontal and vertical concrete and brick surfaces subject to high dynamic stresses. The thickness of the dry layer must be at least 3 mm when dry and at least 4 mm if there is water in pressure. In this case, insert **MAPENET 150** alkali-resistant glass fibre mesh between the two layers. Before laying

WATERPROOFING STRUCTURES INSTALLED BELOW GROUND LEVEL

the product, apply an even coat of **PLASTIMUL PRIMER** (solvent-free, ready-to-use, low-viscosity, quick-drying bitumen emulsion) with a roller, by brush or by spray on the substrate (Fig. 7.51).

PLASTIMUL 1K SUPER PLUS (Fig. 7.52) must be laid in an even layer over the entire surface. If work needs to be interrupted, spread the **PLASTIMUL 1K SUPER PLUS** down to a feather edge and then overlap with the new material by 10 cm when work recommences.

PLASTIMUL 2K PLUS (Fig. 7.53) is a two-component, solvent-free, highly-flexible, quick-drying, low-shrinkage bitumen emulsion with added cellulose fibres suitable for waterproofing horizontal and vertical concrete and brickwork surfaces. **PLASTIMUL 2K PLUS** is easy to apply with a flat or notched trowel or by spray with a peristaltic pump and is resistant to the alkalis in the concrete and aggressive substances usually found in the ground. It is particularly recommended when the waterproofing layer is applied at low temperatures or with high levels of damp or if the layer is applied on smooth surfaces. The thickness of the dry layer must be at least 3 mm when dry and at least 4 mm if there is water in pressure. In this case, insert **MAPENET 150** alkali-resistant glass fibre mesh between the two layers. Before laying the product, apply an even coat of **PLASTIMUL PRIMER** (solvent-free, ready-to-use, low-viscosity, quick-drying bitumen emulsion) with a roller, by brush or by spray to even out the substrate. **PLASTIMUL 2K PLUS** must be applied in an even thickness over the whole surface. If work needs to be interrupted, spread the **PLASTIMUL 2K PLUS** down to a feather edge and then overlap with the new material by 10 cm when work recommences. **PLASTIMUL 2K SUPER** (Fig. 7.54) is a two-component, solvent-free, quick-drying, low-shrinkage, high-flexibility bitumen waterproofing emulsion containing polystyrene spheres. These characteristics make the product easy to apply with a flat or notched trowel on bricks or reinforced concrete. **PLASTIMUL 2K SUPER** is resistant to alkalis in the concrete and aggressive substances normally contained in the ground. The thickness of the dry layer must be at least 3 mm when dry and at least 4 mm if there is water in pressure. In this



Fig. 7.48b – Spreading on ADESILEX PG4 with a trowel



Fig. 7.48d – Spreading on the second layer of ADESILEX PG4 with a trowel



Fig. 7.48c – Positioning MAPEBAND TPE



Fig. 7.48e – Before reticulation of ADESILEX PG4, sprinkle quartz sand on the surface and remove the masking tape

case, insert **MAPENET 150** alkali-resistant glass fibre mesh between the two layers. Before laying the product, apply an even coat of **PLASTIMUL PRIMER** (solvent-free, ready-to-use, low-viscosity, quick-drying bitumen emulsion) with a roller, by brush or by spray on the substrate. **PLASTIMUL 2K SUPER** must be applied in an even thickness over the whole surface. If work needs to be interrupted, spread the **PLASTIMUL 2K SUPER** down to a feather edge and then overlap with the new material by 10 cm when work recommences. Once dry, a process which is accelerated by the hydraulic filling binder contained in the product, **PLASTIMUL 2K SUPER** forms a highly-flexible waterproof dressing coat.

The strong point of **PLASTIMUL 1K SUPER PLUS**, **PLASTIMUL 2K PLUS** and **PLASTIMUL 2K SUPER** is their versatility which makes them suitable for application on a wide range of substrates, such as: limestone masonry, cellular concrete, pumice stone, lightweight bricks and breeze blocks. These substrates do not need to be rendered, but the joints between the bricks or blocks must be grouted with **PLANITOP 400** quick-drying, controlled-shrinkage thixotropic mortar. Then apply a coat of **PLASTIMUL PRIMER** with a roller, by brush or by spray and, when this product has cured, spread on **PLASTIMUL 1K SUPER PLUS**, **PLASTIMUL 2K PLUS** or **PLASTIMUL 2K SUPER**, with **MAPENET 150** alkali-resistant glass fibre mesh between the first and second coat.

After applying the product, check that it is completely dry and, before filling in the trenches, protect the waterproofing layer with a suitable perforation-proof system to ensure it is not damaged and that it remains water-tight.

7.8 WATERPROOFING STRUCTURAL JOINTS

In civil engineering, a structural joint is an interruption in the continuity of a construction. This interruption is indispensable:

- to avoid temperature variations provoking co-action states; in these cases, they allow for free expansion of a structure tens of metres long without damaging or cracking the structure.

WATERPROOFING STRUCTURES INSTALLED BELOW GROUND LEVEL

- To avoid damage by seismic activity; during seismic activity, two adjacent areas of the same structure with different seismic behaviour risk being damaged in the point where they are joined together and hitting each other (hammering phenomenon) if the joint between the two structures is not wide enough allow for free movements.

To overcome such phenomenon, the Italian Construction Techniques Norms & Regulations (Ministerial Decree 14th January 2008, article 7.2.2 General Construction Characteristics) established that the distance between two adjacent constructions must be at least the sum of the maximum calculated horizontal movements according to the Safeguard Limit State (SLS) and, in all cases, never less than the value established by the Norms & Regulations.

Therefore, a well-designed structural joint allows for enough movement of the oscillating components so that the structure remains undamaged by seismic behaviour but, as far as hydraulic sealing is concerned, the joint represents a point which must be treated with particular care. The water tightness of a joint is guaranteed by the use of special PVC waterstops inserted in the cast concrete: **IDROSTOP PVC BE** and **IDROSTOP PVC BI**. **IDROSTOP PVC BE** is a pre-formed, flexible external waterstop made by extruding high quality PVC designed for sealing construction and expansion joints in reinforced concrete structures. In correspondence with the joint, we recommend applying a further strip of **MAPEPROOF** 1 m wide to form a double layer of bentonite sheet between the two sides of the joint. **IDROSTOP PVC BE** is then nailed on top of this strip, which is embedded in the cast concrete (Fig. 7.55).

IDROSTOP PVC BI is a pre-formed, flexible external waterstop made by extruding high quality PVC designed for sealing construction and expansion joints in reinforced concrete structures. The joint is positioned at the mid-point of the foundation pad or wall (Fig. 7.56) and must be stretched and held in position with wire. One end of the wire is attached to the reinforcement rods while the other end is attached to the waterstop.



Fig. 7.49 – Protection of the waterproofing material when re-filling by applying 250 g/m² non woven fabric in a continuous thread



Fig. 7.50 – Using a trowel to apply PLASTIMUL on a vertical retaining wall

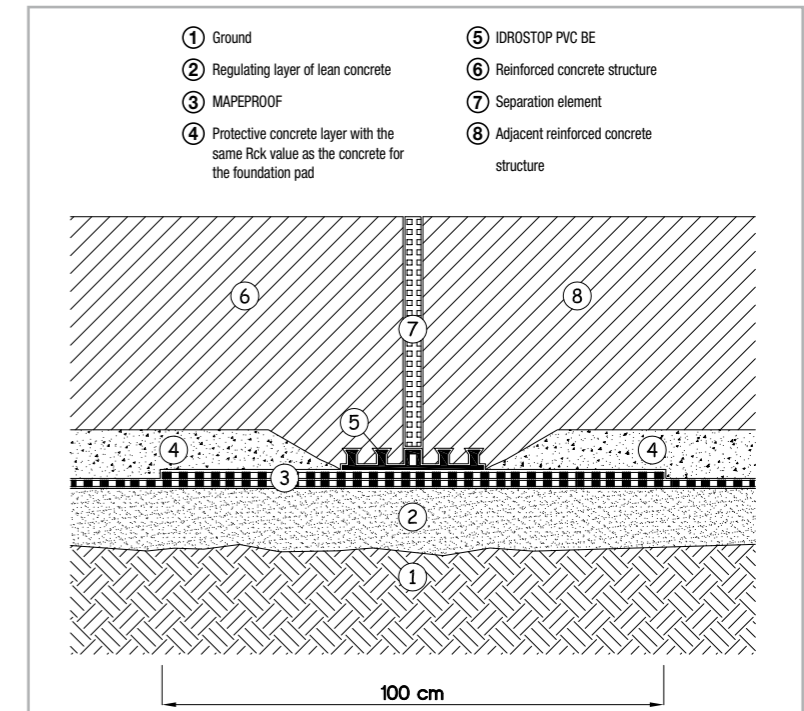

Fig. 7.55 – Detailed layout of sealing a structural joint with IDROSTOP PVC BE

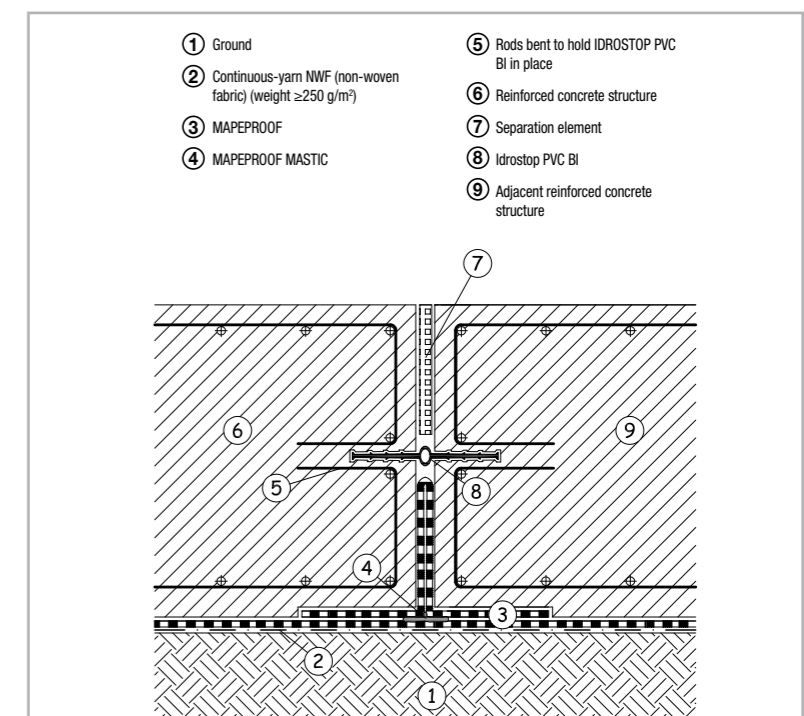

Fig. 7.57 – Detailed layout of sealing a structural joint with IDROSTOP PVC BI

WATERPROOFING STRUCTURES INSTALLED BELOW GROUND LEVEL

Also in this case, we recommend applying a further 1 m wide band of bentonite sheet on the outer face, to be inserted in the joint and bent to form a Ω shape (Fig. 7.57).

7.9 SEALING THROUGH-PIPES IN VERTICAL WALLS AND FOUNDATION PADS

As indicated in the description for laying **MAPEPROOF**, in correspondence with elements which pass through vertical walls and foundation pads, the bentonite sheet must be cut to shape so it fits perfectly around the elements. The interface between different materials forms a preferential route for water and, therefore, it is good practice to take the right precautions to guarantee that it is perfectly watertight. A pipe passing through a vertical wall must be sealed by adopting two precautions.

The first one is to apply **IDROSTOP B25** hydro-expanding bentonite jointing material around the pipe (at the mid-point of the wall) before casting the concrete. The second precaution is to apply a piece of **MAPEPROOF** bentonite sheet around the through element and over the layer already applied, and to seal the edges of the piece of sheet by grouting with **MAPEPROOF MASTIC** (Fig. 7.58).

In the case of through-pipes in the foundation pad (Fig. 7.59), the **MAPEPROOF** sheet must be cut to shape around the pipe and the outer part of the through element must be sealed as follows (Fig. 7.60):

- apply **MAPEPROOF SEAL** natural sodium bentonite in powder form on the sheet.
- Apply **IDROSTOP B25** hydro-expanding bentonite joint around the through element and over the **MAPEPROOF**.
- Seal over the bentonite rib with **MAPEPROOF MASTIC** natural sodium bentonite grout with plasticising additives.



Fig. 7.51 – Using a roller to apply PLASTIMUL PRIMER



Fig. 7.53 – Application of PLASTIMUL 2K PLUS



Fig. 7.52 – Application of PLASTIMUL 1K SUPER PLUS



Fig. 7.54 – Application of PLASTIMUL 2K SUPER

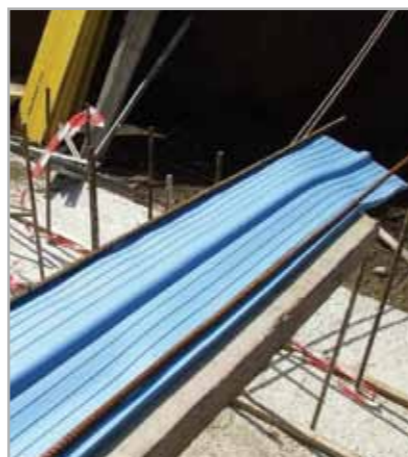

Fig. 7.56a – An example of laying IDROSTOP PVC BI along the centre of a wall when the waterstop has not been clamped in the cast concrete: two lengths of rebar fastened in place with metal wire at the ends of the waterstop



Fig. 7.56b – Demolition to a depth of 15 cm from the upper part of the foundation pad

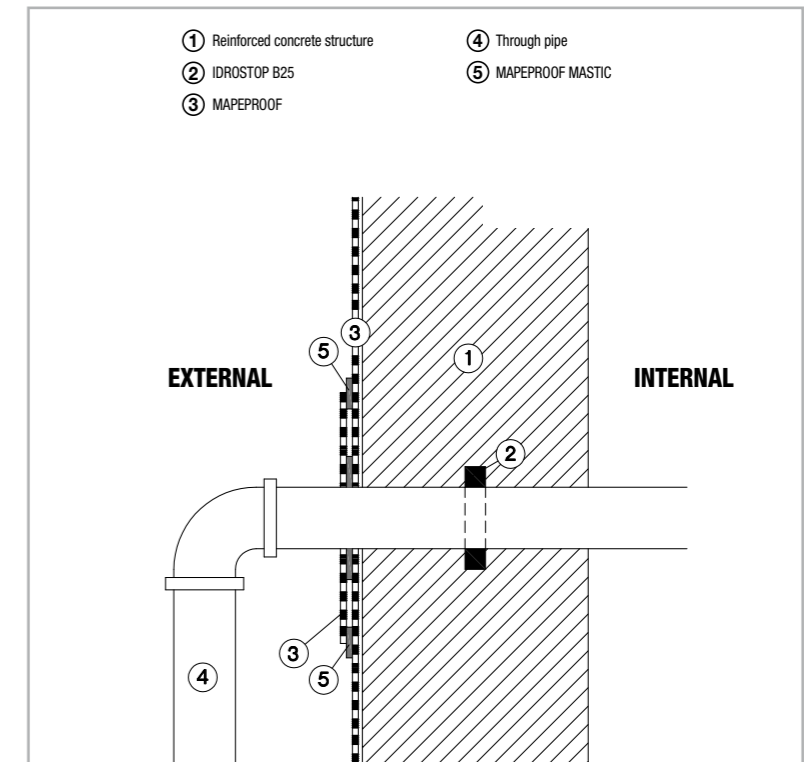

Fig. 7.58 – Detailed layout of sealing a pipe which passes through a facing wall

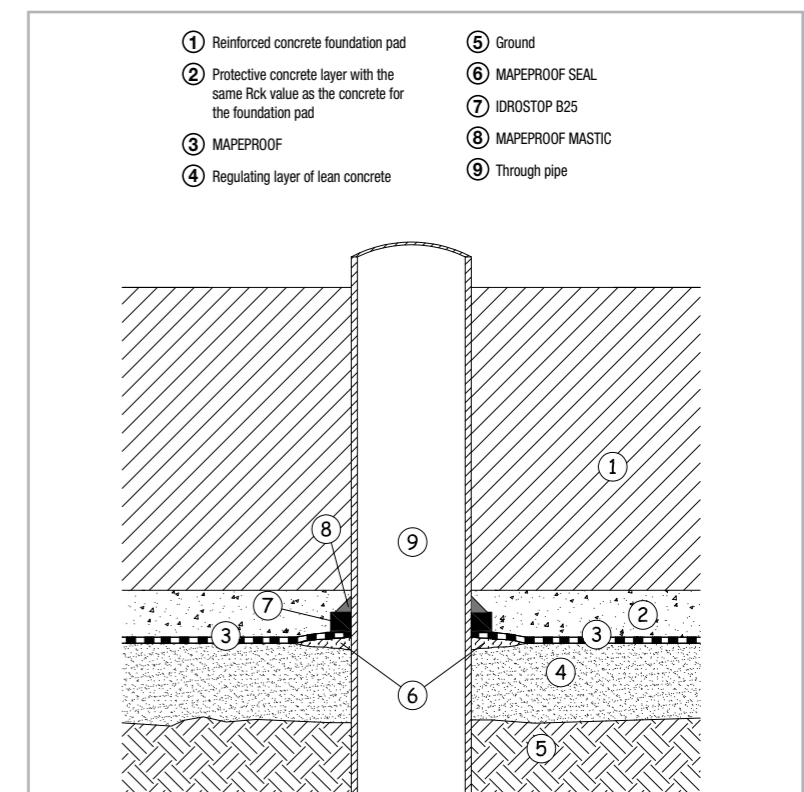

Fig. 7.59 – Detailed layout of sealing a pipe which passes through a foundation pad

7.10 SEALING A DRAINAGE WELL

If drainage wells have been used within the area where the foundation pad is to be laid, they will have to be sealed off (Fig. 7.61-62). Please note that the piping must have anti-slip clamps connected to the steel reinforcement of the foundation pad. After laying the **MAPEPROOF** sheet cut to shape around the well, the outer part of the through element must be sealed as follows:

- apply **MAPEPROOF SEAL** natural sodium bentonite in powder form on the sheet.
- Apply **IDROSTOP B25** hydro-expanding bentonite joint around the well and over the **MAPEPROOF**.
- Seal over the bentonite rib with **MAPEPROOF MASTIC** natural sodium bentonite grout with plasticising additives.

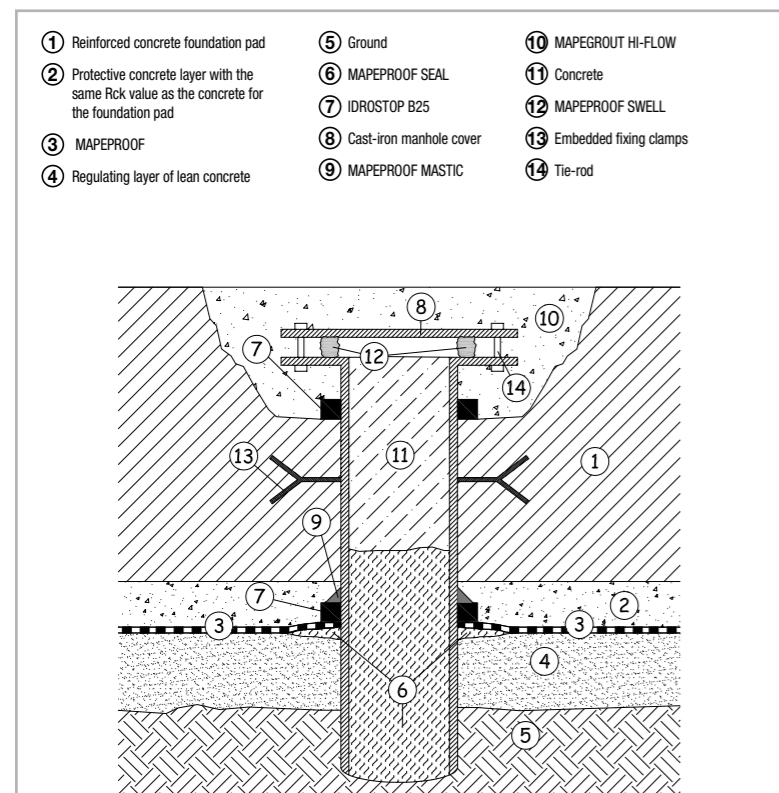

Fig. 7.62 – Detailed layout of sealing a drainage well embedded in the foundation pad



Fig. 7.56c – Positioning and fastening IDROSTOP PVC BI to the steel reinforcement



Fig. 7.60a – One of the phases of sealing a pipe which passes through the foundation pad: application of MAPEPROOF SEAL around the pipe



Fig. 7.56d – Sealing with MAPEPROOF SWELL



Fig. 7.60b – Application of MAPEPROOF MASTIC on the sheet



Fig. 7.56e – Repairing foundations with MAPEGROUT COLABILE



Fig. 7.60c – Laying IDROSTOP B25

After these steps, place formwork around the head of the well to protect it when casting the foundation slab.

When the concrete for the foundation slab has cured, place **IDROSTOP B25** bentonite cord around the well and then block the well with masses of **MAPEPROOF SEAL** natural sodium bentonite in powder form, and then completely fill the well with cast concrete. Before sealing off the well with a metallic cover fixed to the head of the well with stud bolts, seal the joint between the well cover and the well with **MAPEPROOF SWELL** one-component, hydro-expanding paste. The gap left in the foundation slab to seal the well must then be filled by casting in **MAPEGROUT HI-FLOW** controlled-shrinkage, fibre-reinforced mortar for repairing concrete with 30% of gravel with a grain size between 5 and 8-10 mm and 0.25% **MAPECURE SRA** curing compound.

7.11 WATERPROOFING ACCESS RAMPS TO AREAS BELOW GROUND LEVEL

From a structural point of view, access ramps to areas below ground level may be made in one of two ways:

- a) with a reinforced concrete floor slab structurally independent from the rest of the building, laid directly on the ground;
- b) with a foundation pad and side walls to form a box-like structure which runs partly under the ramp and on which the reinforced concrete floor slab of the ramp is then placed.

In the first case, the waterproofing (Fig. 7.63) is installed in various steps, in that the laying surfaces of the ramp and of the foundation pad are different. In the joint between the two structures, a double layer of bentonite sheet must be applied. The procedure is as follows:

- lay two layers of **MAPEPROOF**, with the underside (the dark side) of the geo-textile polypropylene fabric on the inner faces of the formwork and overlap the edges of the sheets by at least 10 cm. Fasten the sheets in place on the lean concrete with nails and **MAPEPROOF CD**

WATERPROOFING STRUCTURES INSTALLED BELOW GROUND LEVEL

plastic washers approximately every 50 cm. Avoid forming creases when laying the fabric on the lean concrete.

- When casting the concrete, protect the ends of the two layers of **MAPEPROOF** with polyethylene sheet.

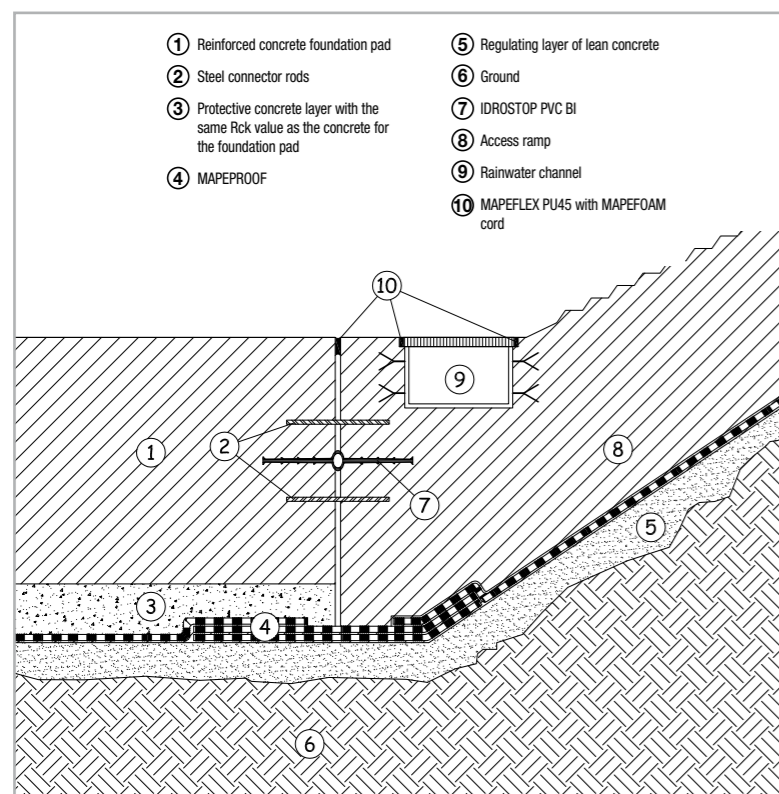

Fig. 7.63 - Detailed layout of waterproofing an access ramp to an underground garage which is structurally independent from the rest of the building

- Apply **IDROSTOP PVC BI** pre-formed waterstop, made by extruding high quality PVC, at the mid-point of the foundation pad, and tighten it with metal wire connected to the waterstop at one end and the steel reinforcement in the wall at the other end.

- Cast the foundation pad.

- Lay **MAPEPROOF** on the lean concrete on the ramp and overlap it on the two layers previously laid after removing the protective



Fig. 7.60d - Fastening IDROSTOP B25 in place with metal wire



Fig. 7.60e - Further grouting with MAPEPROOF MASTIC



Fig. 7.61 - Extrusion of MAPEPROOF SWELL to seal the joint between a manhole cover and a well

polyethylene sheet. Before casting the ramp, place metal guttering to collect rainwater and fix it to the steel reinforcement in the ramp with clamps.

In the second case, the box-like structure must be waterproofed as illustrated previously for waterproofing vertical surfaces after casting (Section 7.7.1), folding the **MAPEPROOF** under the ramp which must then be waterproofed as follows:

- the surfaces to be treated must be clean and free of oil, stripping compound, grease and all traces of dirt or any other material which could potentially compromise the bond of the waterproofing material. The surfaces, therefore, must be thoroughly cleaned by dry sandblasting at a controlled pressure or with high pressure water jets (150-180 atm).

- Eliminate all irregularities in the substrate and smooth over gravel clusters with **MAPEGROUT FAST-SET** fibre-reinforced, controlled-shrinkage, quick setting and hardening mortar for repairing concrete or **PLANITOP 400** quick-setting, controlled-shrinkage thixotropic mortar for repairing the surface of concrete.

- Apply **MAPELASTIC FOUNDATION** two-component, flexible cementitious mortar for waterproofing concrete surfaces subject to positive and negative hydraulic lift (up to 1.5 atm, the equivalent of a 15 m head of water). The product may be applied by brush, with a roller or by spray to form a coat at least 2 mm thick. Approximately 4 hours after applying the first layer in good weather, and in all cases only when the first layer has dried, the second layer may be applied.

7.12 WATERPROOFING DEPURATION TANKS

For collection basins for waste water (Fig. 7.64) the basins must be prepared before applying the waterproofing system as follows:

WATERPROOFING STRUCTURES INSTALLED BELOW GROUND LEVEL

- the inner faces of the basin (floor and walls) must be clean, free of stripping compound, grease, dirt and any other material which could compromise the bond of the waterproofing system. The surfaces, therefore, must be thoroughly cleaned by dry sandblasting at a controlled pressure or with high pressure water jets (150-180 atm).

- Form 5 x 5 cm triangular fillets between the floor of the basin and the vertical walls and between the adjacent walls by applying **EPORIP** two-component, solvent-free epoxy adhesive mortar with a trowel or brush, and then, while it is still fresh, **PLANITOP 430** fine-grained, fibre-reinforced, controlled-shrinkage, medium-strength (30 MPa) thixotropic mortar for repairing concrete.

- Rough areas in the substrate must be smoothed over with **MAPEFINISH** two-component cementitious mortar for finishing off concrete, applied by trowel at a thickness of up to 2-3 mm. After the **MAPEFINISH** has cured, apply **TRIBLOCK P** three-component epoxy primer, with the capacity of reticulating on damp surfaces, including particularly smooth ones (such as porcelain and ceramic tiles, marble, etc.), on the floor and walls of the basin to create an efficient barrier against rising damp to guarantee a good bond, including in conditions of positive lift, of the waterproofing layer. **TRIBLOCK P** diluted accordingly is applied in two coats by brush, with a roller or by airless spray on the surfaces to be treated. The two coats should be applied criss-crossed, making sure that they are also applied evenly. The second coat may be applied 4-6 hours after the first one.

- Approximately 24 hours after applying the second coat of **TRIBLOCK P**, cover all the surfaces of the basin with **DURESIL EB** protective anti-acid treatment made from two-component epoxy paint modified with hydrocarbon resin and special additives, resistant to freezing weather and direct sunlight. Apply the product in two coats using conventional



Fig. 7.64 – Sedimentation tank in an advanced state of deterioration

methods, such as by brush with a roller or by airless spray. Wait from 6 to 24 hours between the first and second coat, according to the surrounding conditions.

- Once it has completely hardened, **DURESIL EB** may come into contact with sewage waste and, therefore, may be used for coating depuration basins and basins for run-off water from drains. It is resistant to acids, diluted alkalis, base materials, salts, mineral oil and hydrocarbons, as well as the main aggressive chemical products carried in sewage waste such as chlorides and sulphates, and protects against the aggressive action of carbonatation and freeze/thaw cycles.

7.13 WATERPROOFING A SEWAGE WASTE OUTLET AND VENT CAST IN PLACE

Waterproofing of a sewage waste outlet and vent cast in place is carried out by taking special care when folding over the **MAPEPROOF** (laid on the vertical wall) inside the hole in the wall for the structure. The 250 g/m² non-woven fabric used to protect the waterproofing layer must also be folded into the hole in the wall for when the structure is filled in up to the base of the sewage waste outlet and vent. Fill in trenches and gaps with homogenous fine and mixed loose earth in well-compacted layers 40 to 50 cm thick, to guarantee that, once the filling operations have been completed, there are no gaps or voids and there is better confinement of the system. Then cast a layer of lean concrete 10 cm thick to even out the horizontal laying surface, on which the **MAPEPROOF** folded into the hole for the structure is then overlapped, then seal the construction joints between the walls of the building and the base of the sewage waste outlet and vent by applying **IDROSTOP B25** in between the steel reinforcement. **MAPEPROOF** is then applied in the formwork where the foundation pad of the sewage waste outlet and vent is to be cast, and then folded over onto the lean concrete to guarantee that it overlaps with the sheet on the horizontal surface. The rolls of **MAPEPROOF** must be positioned with the underside (the darker side) of the geo-textile polypropylene fabric

WATERPROOFING STRUCTURES INSTALLED BELOW GROUND LEVEL

around the formwork, while the upper side (the lighter side) is folded on the inside so it is visible. The edges of the sheets must overlap by at least 10 cm. Fasten the sheets in place to the lean concrete with nails and **MAPEPROOF CD** polyethylene washers approximately every 50 cm. The steel reinforcement for the foundation pad must be placed on special plastic spacers to help the concrete to flow under the reinforcement and guarantee that it is well covered. After positioning the steel reinforcement, pour on the concrete for the base of the sewage waste outlet and vent according to the specifications for the concrete in Section 6. After casting the base for the sewage waste outlet and vent and once the base has cured, seal the construction joints between the base and side walls of the sewage waste outlet and vent with **IDROSTOP B25** hydro-expanding bentonite joint, nailed in place every 25 cm at the mid-point of the section of the vertical walls between the steel reinforcement rods. Then seal the formwork and cast the vertical reinforced concrete walls with concrete according to the specifications in Section 6). The sealing operation with **IDROSTOP B25** must be repeated for each construction joint in the vertical walls, making sure that the rib laid vertically between the walls is laid alongside the rib on the horizontal surface for at least 6 cm. As an alternative, **IDROSTOP** hydro-expanding rubber profile for waterproofing working joints up to a pressure of 5 atm may also be used. Once the cast walls have cured, the surface of the reinforced concrete must be smoothed over as follows: remove the spacers to a depth of 1-2 cm, smooth over the rough areas and gravel clusters with **PLANITOP 400** quick-setting, compensated-shrinkage, thixotropic mortar for quick repairs on the surface of concrete, or with **PLANITOP 430** fine-grained, fibre-reinforced, compensated-shrinkage thixotropic mortar for repairing deteriorated concrete or products from the **MAPEGROUT** range. A strip at least 50 cm wide at the top of the wall of the sewage waste outlet and vent must be waterproofed with **MAPELASTIC FOUNDATION** applied in two coats to form a layer at least 2 mm thick.

Then lay the **MAPEPROOF** starting from the top, making sure that it overlaps the **MAPELASTIC FOUNDATION** by at least 20 cm. In the fillet

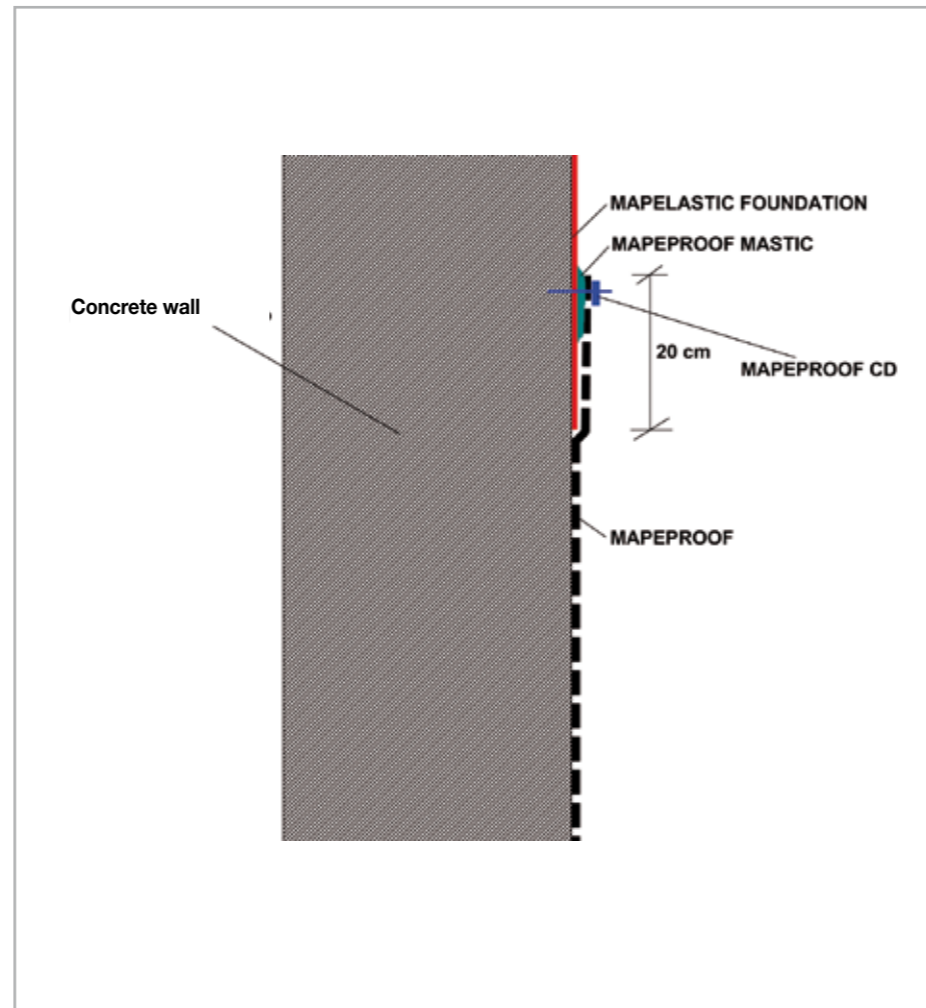

Fig. 7.65 - Schematic layout of sealing a fillet joint between MAPEPROOF and MAPELASTIC FOUNDATION using MAPEPROOF MASTIC

between the two systems, apply **MAPEPROOF MASTIC** on top of the **MAPELASTIC FOUNDATION** (Fig. 7.65). When applied after casting, the bentonite sheets are laid with the upper side of the geo-textile fabric (the white side) against the reinforced concrete wall, while the underside of the geo-textile fabric (the darker side) faces the outside. Please note that the white non-woven fabric of **MAPEPROOF** must always be laid in contact with the surface to be waterproofed. Avoid forming creases when laying the fabric. When laying near to pipe-work which passes through the surface, the sheets must be cut to shape to suit the shape of such elements, which must then be sealed as described in Section 7.9. After laying the **MAPEPROOF**, lay 250 g/m² non-woven fabric to protect the waterproofing layer when filling in excavations.

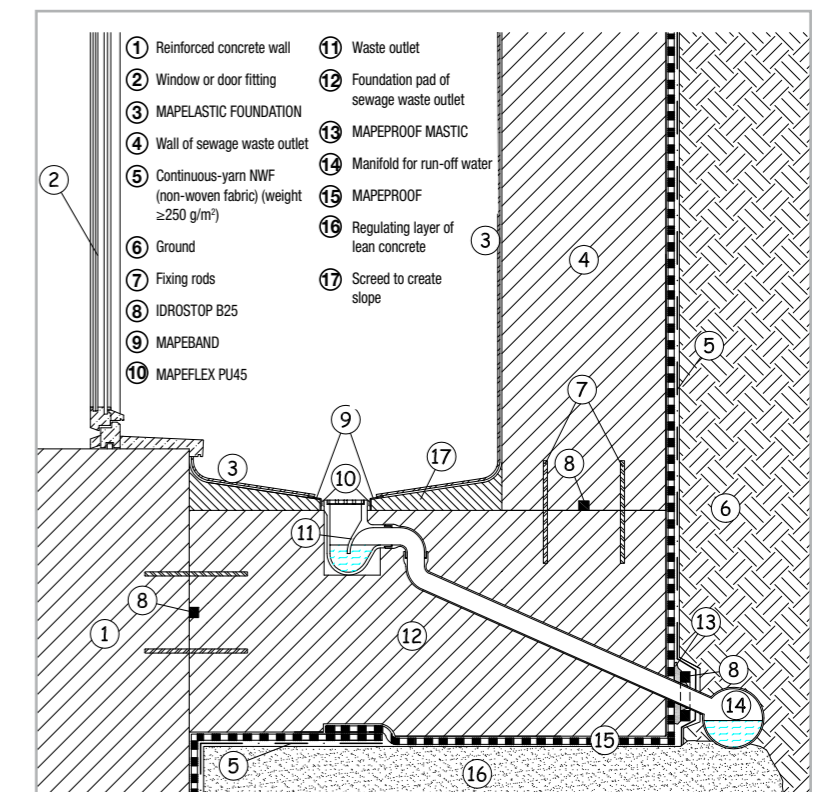

Fig. 7.64 - Detailed layout of waterproofing an aeration outlet cast in place

Fill with homogenous fine and mixed loose earth in well-compacted layers 40 to 50 cm thick, to guarantee that, once the filling operations have been

WATERPROOFING STRUCTURES INSTALLED BELOW GROUND LEVEL

completed, there are no gaps or voids and there is better confinement of the system. The sewage waste outlet and vent is also waterproofed (Fig. 7.64) on the inside to avoid rainwater seeping into the reinforced structure, otherwise it may deteriorate prematurely and reduce its service life. The surface to be treated must be solid and perfectly clean. Remove any cement laitance present on the surface, as well as loose and crumbly parts and traces of dust, stripping compound and grease by sandblasting or with high pressure water jets. Even out the surface as described previously for the outer face of the walls of the sewage waste outlet and vent, and then waterproof the surface with **MAPELASTIC FOUNDATION** two-component, flexible cementitious mortar for waterproofing concrete surfaces subject to positive and negative hydraulic lift. In correspondence with the hole for the floor drain, apply a special shaped piece of **MAPEBAND** rubber tape with a felt backing resistant to alkalis bonded to the substrate with **MAPELASTIC FOUNDATION**. **MAPELASTIC FOUNDATION** is applied by brush or with a roller to form a layer at least 2 mm thick. Approximately 4 hours after applying the first layer, and in all cases only when the first layer has dried, the second layer may be applied.

7.14 WATERPROOFING STRUCTURES BUILT USING THE TOP-DOWN METHOD

The top-down method was described briefly at the end of Section 4. The waterproofing (Fig. 7.65) of a construction built using this method must be made starting from the top working downwards. In fact, after preparing the temporary structures, a hole is excavated for the first floor slab, which is cast on the ground where polyethylene sheets have been placed (Fig. 7.66) to improve its final appearance. When it has cured, the ground is dug out under the floor slab through special passages or accesses to the future ramp. Special attention must be paid to guarantee that the waterproofing layer is continuous in correspondence with the anchorage points for the ends of the floor slab in the bulkheads for the excavation. In fact, if care is taken with these construction features, it will guarantee that the basement is waterproof. When installing the intermediate floor slabs,



Fig. 7.66 - Application of a sheet of PE to form a floor slab with a regular inner side



Fig. 7.67 - Taking measurements before cutting MAPEPROOF sheets: start laying the sheets at least 1 m from the bottom of the excavation



Fig. 7.68 - Bentonite sheet laid on the vertical surface and then hemmed over onto the horizontal surface



Fig. 7.69 - Grouting metallic connectors with MAPEPROOF MASTIC



Fig. 7.70 - Application of MAPELASTIC FOUNDATION on the topping beams on the bulkhead



Fig. 7.71 - Sealing a fillet joint between MAPELASTIC FOUNDATION and MAPEPROOF with MAPEPROOF MASTIC and then nailing IDROSTOP B25 in place

once the ground has been dug out to the external face of the floor slab, the surface of the containment walls must be cleaned with high pressure water jets (180-300 atm) and levelled off with **MAPEGROUT T60** sulphate-resistant, fibre-reinforced thixotropic mortar with 0.25% of **MAPECURE SRA**.

Then lay on the **MAPEPROOF** starting at least 1 m (Fig. 7.67) from the bottom of the excavation and overlap the sheets by at least 10 cm. Fix the sheets in place with nails and **MAPEPROOF CD** polyethylene washers approximately every 30 cm. **MAPEPROOF** must be folded over (Fig. 7.68) onto the ground, making sure that it is protected by a sheet of polyethylene to guarantee that the concrete does not attach to the **MAPEPROOF** and that it is protected and undamaged until all work is completed. The bentonite sheet and bulkheads must then be perforated so that the metal connectors used to anchor the floor slab may be cast firmly in place. These anchor points are then sealed by applying **MAPEPROOF MASTIC** (Fig. 7.69) natural sodium bentonite grout with plasticising additives. The cycle described above must be repeated for each intermediate floor slab until the level of the foundation pad is reached where, unlike other floor slabs, the hem of the **MAPEPROOF** is not protected by a sheet of polyethylene, but overlaps the bentonite sheet applied all over the surface of the lean concrete. On the surface, to guarantee continuity of the waterproofing layer, **MAPEPROOF** is overlapped with the sheet laid before casting the floor slab.

The topping beam on the bulkhead must also be waterproofed. Clean the surfaces with high pressure water jets (180-300 atm) and then smooth off the surface with **PLANITOP 400** quick-setting, compensated-shrinkage, thixotropic mortar for quick repairs on the surface of concrete, or with **PLANITOP 430** fine-grained, fibre-reinforced, compensated-shrinkage thixotropic mortar for repairing deteriorated concrete or products from the **MAPEGROUT** range. Once the surface has been evened off, apply **MAPELASTIC FOUNDATION** (Fig. 7.70) in two coats one after the other using a roller, brush or by spray to form a layer at least 2 mm thick. Approximately 4 hours after applying the first layer in good weather, and in all cases only when the first layer has dried, the second layer may be

WATERPROOFING STRUCTURES INSTALLED BELOW GROUND LEVEL

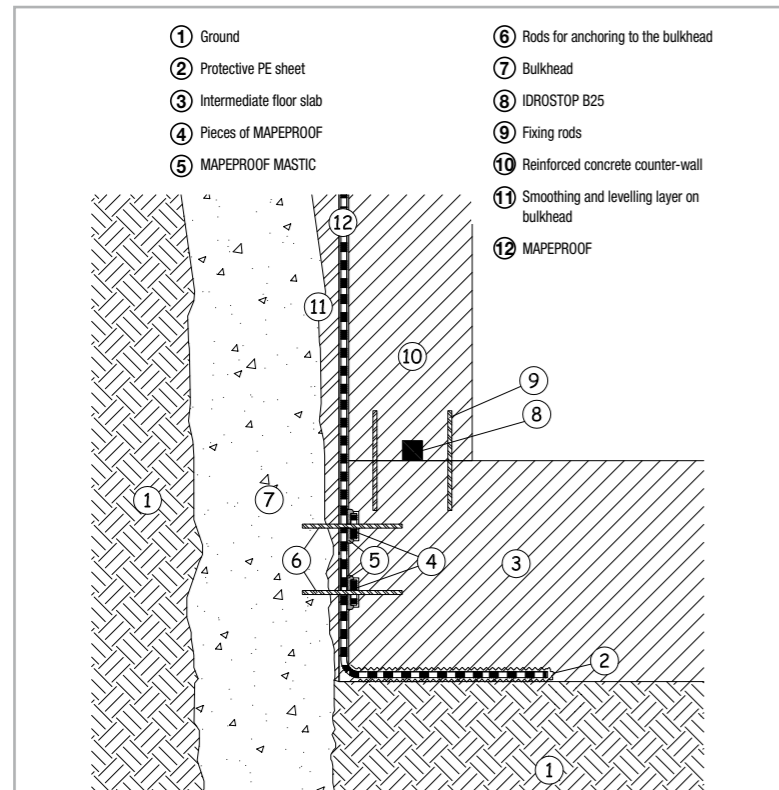

Fig. 7.65 – Detailed layout of waterproofing the end of an intermediate floor slab in a top-down construction

applied. **MAPELASTIC FOUNDATION** must be spread over all the front face of the topping beam, on the inner face of the beam and on the upper face of the bulkhead, so it may be overlapped with **MAPEPROOF** for at least 30 cm to form a completely water-tight system. The fillet joint between **MAPEPROOF** and **MAPELASTIC FOUNDATION** must be sealed by applying **IDROSTOP B25**. In certain cases, this seal may be reinforced by grouting with **MAPEPROOF MASTIC** (Fig. 7.71) between the **MAPELASTIC** and **MAPELASTIC FOUNDATION** before applying **IDROSTOP B25**, and then extruded **MAPEPROOF SWELL** (Fig. 7.72)



Fig. 7.72 – Extrusion of MAPEPROOF SWELL onto IDROSTOP B25 in the fillet joint between MAPELASTIC FOUNDATION and MAPEPROOF



Fig. 7.74 – MAPEPROOF, applied before casting the floor slab, is hemmed over to guarantee that it overlaps with the next sheet laid on the vertical surface



Fig. 7.73 - Excavation work carried out under the reinforced concrete foundation pad cast before excavating



Fig. 7.75 – A hole left in the floor slab to pour concrete into the vertical walls

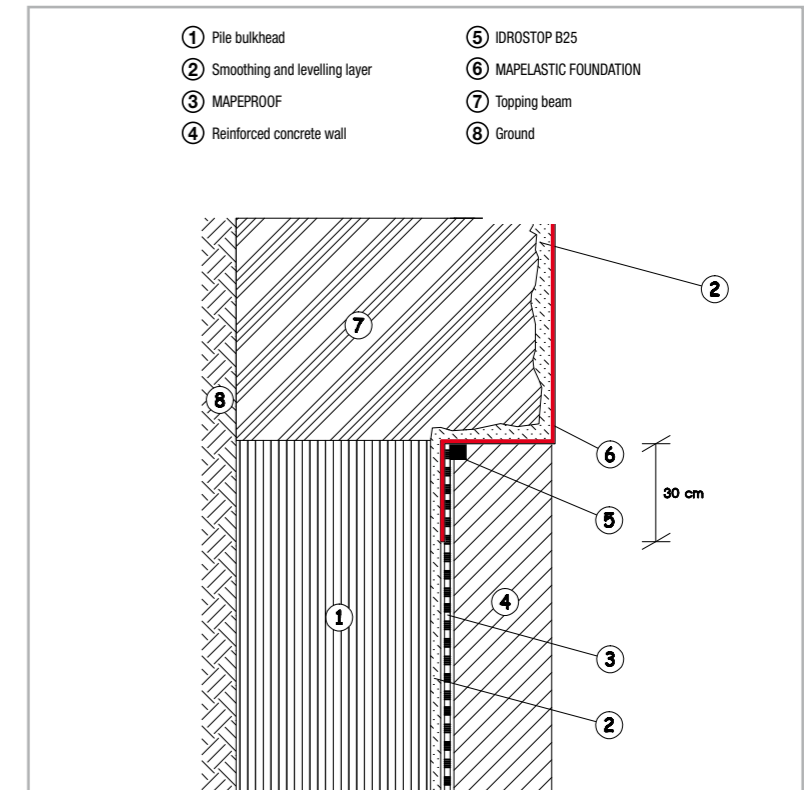

Fig. 7.76 – Waterproofing the topping beam on a bulkhead

8. WATERPROOFING EXISTING STRUCTURES BELOW GROUND LEVEL

Up until this point, we have discussed waterproofing interventions carried out on new constructions. Very often, however, the water tightness of existing structures must also be guaranteed, and for which no waterproofing system had been considered during the design phase.

Also, it is quite common to carry out interventions on existing waterproofing systems which are no longer capable of carrying out their original function. Below we will discuss and analyse a number of conditions which often occur on existing structures, and supply suitable technical solutions to be adopted, the products to be used and the methods for laying and applying these products. All the information will be accompanied by specific technical details.

8.1 LINING SURFACES IN ROOMS BELOW GROUND LEVEL

If water seeps into rooms below ground level, there are various ways to intervene:

- waterproof the vertical surfaces (**MAPELASTIC FOUNDATION**);
- waterproof both the horizontal and vertical surfaces (**MAPEPROOF** or **MAPEPROOF** in conjunction with **MAPELASTIC FOUNDATION**).

Below, for each type of intervention mentioned above, there is a description of the application cycle of the waterproofing system.

8.1.1 WATERPROOFING VERTICAL SURFACES AFTER CASTING

This type of intervention is carried out when water from vertical facing walls seeps into the room, mainly due to percolating water present in the ground. In this case, only the retaining walls will be involved, and consists in treating the surfaces with **MAPELASTIC FOUNDATION** two-component, flexible cementitious mortar specially developed for waterproofing surfaces subjected to negative and positive hydraulic lift. The various phases for this type of application are described below.

Concrete walls

- Remove the render down to the level of the underlying masonry.
- Remove the gravel clusters and level off the vertical surfaces with **PLANITOP 400** quick-setting, compensated-shrinkage, thixotropic mortar for quick repairs on the surface of concrete, or with **PLANITOP 430** fine-grained, fibre-reinforced, compensated-shrinkage thixotropic mortar for repairing deteriorated concrete or products from the **MAPEGROUT** range.



Fig. 8.1a - One of the phases of sealing a construction joint: mechanical demolition around a construction joint to a depth of approximately 6 cm



Fig. 8.1b - Extrusion of MAPEPROOF SWELL



Fig. 8.1c - Construction joint sealed with MAPEPROOF SWELL



Fig. 8.1d - Confinement of MAPEPROOF SWELL by applying MAPEGROUT T40



Fig. 8.1e - A sealed, repaired construction joint



Fig. 8.2 - Sealing a pipe passing through the surface by extruding MAPEPROOF SWELL and then confining the pipe with MAPEGROUT BM

- Construction joints (Fig. 8.1), cracks in the substrate and pipe-work (Fig. 8.2) and other elements which pass through the concrete walls must be sealed with **MAPEPROOF SWELL** one-component, hydro-expanding paste for waterproof seals. Carefully demolish the area around the through elements, cracks and construction joints with suitable tools to a depth of at least 6 cm. To seal construction joints between old substrates and repairs, extrude **MAPEPROOF SWELL** and then repair the substrate with **MAPEGROUT T40** or **MAPEGROUT BM** mortar. When demolishing the areas, if water continues to seep through, stop the flow with **LAMPOSILEX** quick-setting and hardening hydraulic binder for stopping infiltration of water (Fig. 8.3).

- Once the surface has been smoothed off, apply two coats of **MAPELASTIC FOUNDATION** with a brush, a roller or by spray to form a layer at least 2 mm thick. Approximately 4 hours after applying the first layer in good weather, and in all cases only when the first layer has dried, the second layer may be applied. Once the **MAPELASTIC FOUNDATION** is completely cured, spread a layer of **POROMAP INTONACO** macro-porous, de-humidifying render which acts as an anti-condensation buffer on the new waterproofing system (following the cycle indicated on the Technical Data Sheet).

Brick walls

- Remove the deteriorated render down to the level of the underlying brickwork.
- Pipe-work and other elements which pass through the concrete walls must be sealed with **MAPEPROOF SWELL** one-component, hydro-expanding paste for waterproof seals. Carefully demolish the area around the through elements, cracks and construction joints with suitable tools to a depth of at least 6 cm. Extrude **MAPEPROOF SWELL** around the through elements and then repair the substrate with **MAPEGROUT**

WATERPROOFING STRUCTURES INSTALLED BELOW GROUND LEVEL

BM mortar. When demolishing the areas, if water continues to seep through, stop the flow with **LAMPOSILEX** quick-setting and hardening hydraulic binder for stopping infiltration of water.

- Smooth over the surfaces with a new layer of render 2 cm thick, reinforced with metal mesh fastened to the substrate with plugs. For the new layer of render, apply **MAPEGROUT T60** sulphate-resistant, fibre-reinforced thixotropic mortar or **MAPEGROUT BM** two-component mortar with a low modulus of elasticity. As a substitute for the reinforced render, the surface may be smoothed over with **PLANITOP HDM MAXI** two-component, fibre-reinforced, high-ductile mortar made from pozzolan-reaction binders in conjunction with **MAPEGRID G 120** or **MAPEGRID G 220** alkali-resistant, primed glass fibre mesh.

- When the render is cured, apply two coats of **MAPELASTIC FOUNDATION** with a brush, a roller or by spray to form a layer at least 2 mm thick. Approximately 4 hours after applying the first layer in good weather, and in all cases only when the first layer has dried, the second layer may be applied. Once the **MAPELASTIC FOUNDATION** is completely cured, spread a layer of **POROMAP INTONACO** macro-porous, de-humidifying render which acts as an anti-condensation buffer on the new waterproofing system (following the cycle indicated on the Technical Data Sheet).

8.1.2 WATERPROOFING HORIZONTAL AND VERTICAL SURFACES WITH MAPEPROOF

This type of intervention is carried out whenever the storey below ground level is infiltrated with water from the floor and vertical retaining walls due to the presence of groundwater under pressure. In these cases, various techniques and products may be used according to the construction characteristics of the structure and the hydrostatic pressure which acts on the substrates. The various steps are listed below.



Fig. 8.3 – Extrusion of MAPEPROOF SWELL on a zone damaged by seeping water blocked beforehand with LAMPOSILEX

- Demolish the first 3 or 4 steps of any stairways present in the area below ground level. All the partition walls, floors and substrates must also be removed.

- Level off the vertical surfaces with **PLANITOP 400** quick-setting, compensated-shrinkage, thixotropic mortar for quick repairs on the surface of concrete, or with **PLANITOP 430** fine-grained, fibre-reinforced, compensated-shrinkage thixotropic mortar for repairing deteriorated concrete or products from the **MAPEGROUT** range.

- Construction joints, cracks in the substrate and pipe-work and other elements which pass through the substrates must be sealed with **MAPEPROOF SWELL** one-component, hydro-expanding paste for waterproof seals. Carefully demolish the area around the through elements, cracks and construction joints with suitable tools to a depth of at least 6 cm. To seal construction joints between old substrates and repairs, extrude **MAPEPROOF SWELL** and then repair the substrate with **MAPEGROUT T40** or **MAPEGROUT BM** mortar. When demolishing the areas, if water continues to seep through, stop the flow with **LAMPOSILEX** quick-setting and hardening hydraulic binder for stopping infiltration of water.

- Line the inner faces of the room by applying **MAPEPROOF** sheets on the horizontal and vertical surfaces (Fig. 8.4-5) by positioning the underside (the dark side) of the geo-textile fabric on the surface of the lean concrete and the vertical walls and the upper side of the fabric (the white side) facing upwards so it is visible. The edges must overlap by at least 10 cm. Fasten the sheets in place to the substrate with nails and **MAPEPROOF CD** polyethylene washers approximately every 50 cm on horizontal surfaces and every 30 cm on vertical surfaces. When laying the product around through elements (pillars, pipe-work, etc.) the sheets must be cut to shape so they fit perfectly around the elements, which

WATERPROOFING STRUCTURES INSTALLED BELOW GROUND LEVEL

must also be sealed with **IDROSTOP B25** (in certain cases, it may be necessary to extrude **MAPEPROOF SWELL** over the **IDROSTOP B25**). Make sure there are absolutely no creases when laying the sheets.

- If there is a horizontal structure to which the new foundations may be anchored, the **MAPEPROOF** must be perforated so that metallic connectors may be cast in place. This operation means that the thickness of the new foundations may be lower, in that the old structure will act as ballast for the new one. **MAPEPROOF** must be perforated according to the results of structural calculations. Apart from the thickness of the new floor slab and walls, the structural analysis must also indicate the number per square metre and diameter of the metallic connectors which must be used on the horizontal surfaces (foundation pad) and vertical surfaces (walls). Anchorage of the connectors to the horizontal surfaces must be carried out by casting **EPOJET** super-fluid epoxy resin, while **ADESILEX PG1** two-component, thixotropic epoxy adhesive must be used for the vertical surfaces. The points in which the connectors pass through the sheets must be grouted with **MAPEPROOF MASTIC**.

- After carrying out the operations described above, position the steel reinforcement for the new reinforced concrete floor slab on the horizontal surfaces, at a suitable distance from the **MAPEPROOF** sheets using plastic spacers. These spacers allow the concrete to flow freely under and around the steel reinforcement and guarantee that the reinforcement is well covered. Then cast the reinforced concrete, the thickness of which must be sufficient to resist the hydraulic lift from the ground water.

- After casting and curing the concrete for the new foundation pad, position **IDROSTOP B25** hydro-expanding bentonite cord between the steel reinforcement for the walls and cast the concrete to form the



Fig. 8.5a – One of the phases of lining the inside of a room with MAPEPROOF on the horizontal and vertical surfaces: application of MAPEPROOF on the lower part of the vertical walls with the sheet hemmed over onto the lean concrete



Fig. 8.5b – After laying the sheet on the horizontal surface, the steel reinforcement for casting the reinforced concrete floor slab and counter-wall is placed in position

vertical structures, which must also be connected to the existing walls of the area below ground level with new anchored, sealed metallic connectors. The 20x25 mm jointing material must be nailed to the substrate every 25 cm. The sealing operation with **IDROSTOP B25** must be repeated for each construction joint in the vertical walls, making sure that the rib laid vertically between the walls is laid alongside the rib on the horizontal surface for at least 6 cm. As an alternative, **IDROSTOP** hydro-expanding rubber profile for waterproofing working joints up to a pressure of 5 atm may also be used. Before applying **IDROSTOP B25**, carefully clean the surface to eliminate all traces of debris, and especially the slurry which usually bleeds from the surface when compacting the cementitious conglomerate used for the foundation pad.

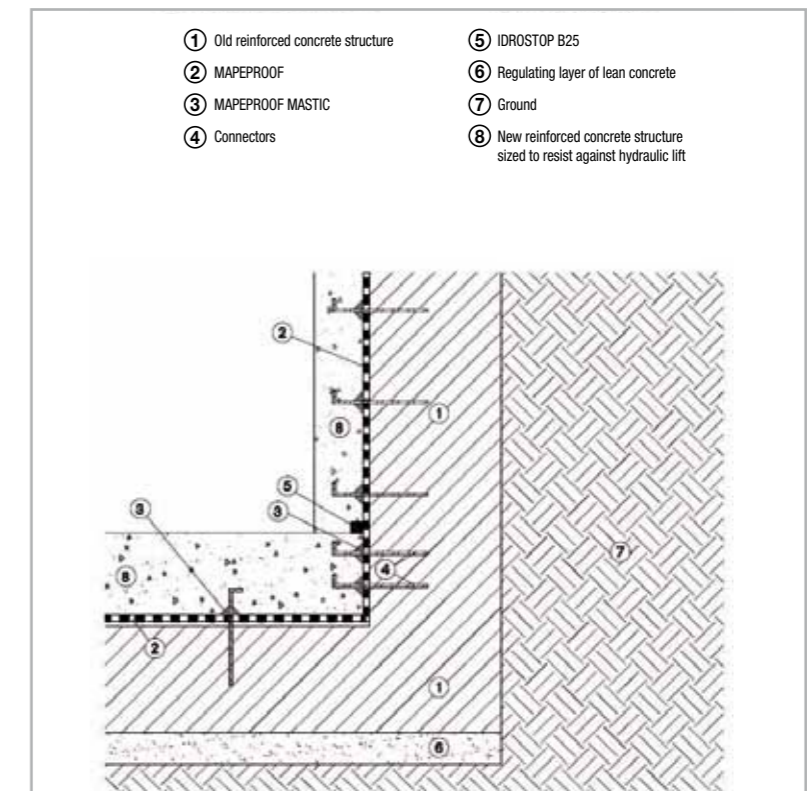

Fig. 8.4 – Detailed layout of relining the inside of a room by applying Mapeproof on the horizontal and vertical surfaces and then casting the reinforced concrete floor slab and retaining walls

WATERPROOFING STRUCTURES INSTALLED BELOW GROUND LEVEL

- Then seal all the formwork and cast the reinforced concrete counter-walls. The thickness of the walls must be calculated to resist the hydraulic lift from the groundwater. The concrete counter-walls may also be made to form a single body with the existing structure following the indications described previously.

8.1.3 WATERPROOFING HORIZONTAL AND VERTICAL SURFACES WITH A COMBINED BENTONITE-CEMENTITIOUS SYSTEM

The choice of which system to use for this type of intervention does not depend on the hydrostatic pressure acting on the structure (bear in mind that **MAPELASTIC FOUNDATION** is highly resistant to negative lift, up to 1.5 bar or a 15 m head of water), but rather on two main factors: the space available in the room below ground level and the time required to carry out the work. It is quite obvious that lining the inner surfaces with **MAPEPROOF** reduces the area available in the room below ground level, in that the counter-wall must be thick enough to resist the hydraulic lift of the groundwater. The use of a cementitious system, on the other hand, does not reduce the space available but may lead to long delays when carrying out the work if it has to be applied on a reinforced render levelling layer. Therefore, when choosing which system to use in rooms below ground level, the analysis must take into consideration both the technique and time aspects and the overall cost of the intervention.

Concrete walls

- Demolish the first 3 or 4 steps of any stairways present in the area below ground level. All the partition walls, floors and substrates must also be removed.

- Level off the vertical surfaces with **PLANITOP 400** quick-setting, compensated-shrinkage, thixotropic mortar for quick repairs on the surface of concrete, or with **PLANITOP 430** fine-grained, fibre-



Fig. 8.5c - Reinforced concrete floor slab cast on the MAPEPROOF at a thickness calculated to withstand hydraulic lift from the groundwater



Fig. 8.5d - Sealing a fillet joint between MAPEPROOF and MAPELASTIC FOUNDATION with IDROSTOP B25



Fig. 8.6a - One of the phases of relining the inside of a room with MAPELASTIC FOUNDATION on the vertical walls and MAPEPROOF on the horizontal surfaces: application of MAPELASTIC FOUNDATION on the vertical walls and on the new lean concrete at a width of at least 50 cm



Fig. 8.6d - Metal connectors are required to make the new structure part of the existing one

reinforced, compensated-shrinkage thixotropic mortar for repairing deteriorated concrete or products from the **MAPEGROUT** range.

- Construction joints, cracks in the substrate and pipe-work and other elements which pass through the substrates must be sealed with **MAPEPROOF SWELL** one-component, hydro-expanding paste for waterproof seals. Carefully demolish the area around the through elements, cracks and construction joints with suitable tools to a depth of at least 6 cm. To seal construction joints between old substrates and repairs, extrude **MAPEPROOF SWELL** and then repair the substrate with **MAPEGROUT T40** or **MAPEGROUT BM** mortar. When demolishing the areas, if water continues to seep through, stop the flow with **LAMPOSILEX** quick-setting and hardening hydraulic binder for stopping infiltration of water.

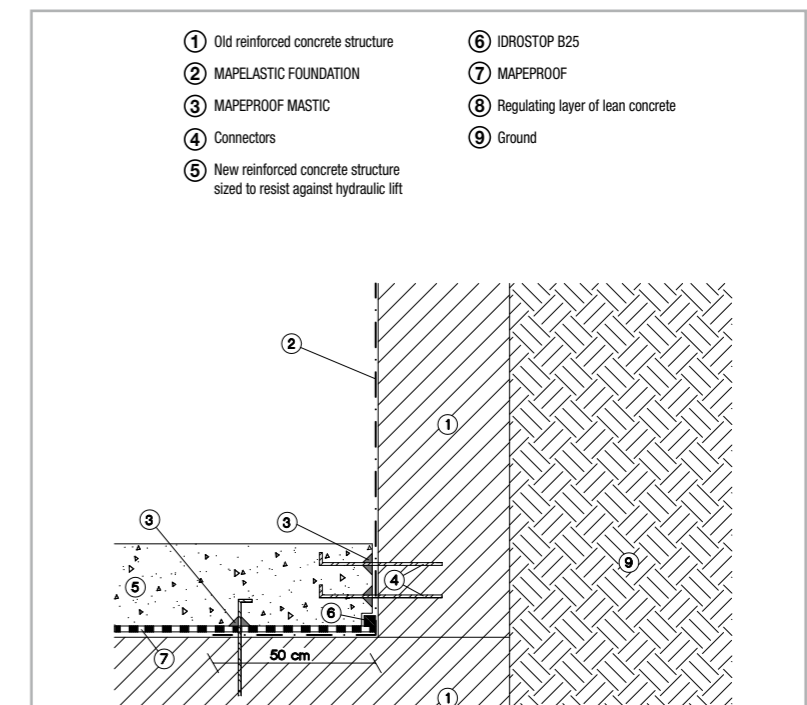

Fig. 8.7a - Detailed layout of relining the inside of a room by applying MAPEPROOF on the horizontal surfaces and MAPELASTIC FOUNDATION on the vertical surfaces: fillet joint between the floor slab and retaining wall

WATERPROOFING STRUCTURES INSTALLED BELOW GROUND LEVEL

- On the vertical walls (Fig. 8.6-7) and horizontal surfaces, apply two coats of **MAPELASTIC FOUNDATION** one after the other to form a strip at least 50 cm wide with a brush, a roller or by spray to form a layer at least 2 mm thick. Approximately 4 hours after applying the first layer in good weather, and in all cases only when the first layer has dried, the second layer may be applied.

- When applying the waterproofing system on horizontal surfaces, refer also to the indications at the end of this Section.

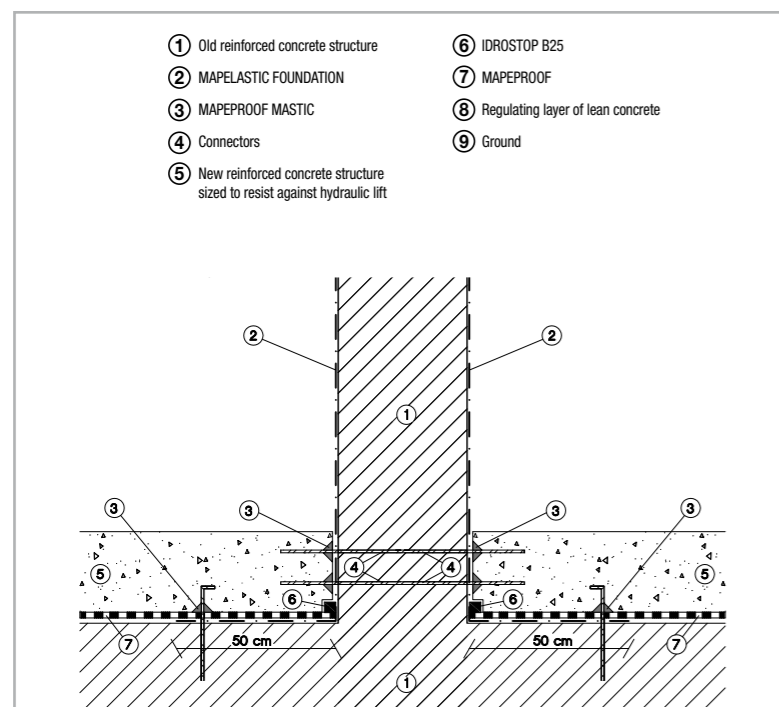

Fig. 8.7b - Detailed layout of relining the inside of a room by applying MAPEPROOF on the horizontal surfaces and MAPELASTIC FOUNDATION on the vertical surfaces: fillet joint between the floor slab and a pillar or parting wall

Brick walls

- Demolish the first 3 or 4 steps of any stairways present in the area below ground level. All the partition walls, floors and substrates must also be removed.



Fig. 8.6b - MAPELASTIC FOUNDATION is also applied also on the pillars



Fig. 8.6e - Lay IDROSTOP B25 in correspondence with the joints between MAPELASTIC FOUNDATION and MAPEPROOF



Fig. 8.6c - After laying MAPEPROOF on the lean concrete, make holes to insert the metal connectors



Fig. 8.6f - Grouting the metal connectors with MAPEPROOF MASTIC



Fig. 8.6g - Metal connectors grouted before positioning the steel reinforcement for the new floor slab to be installed

- Remove the deteriorated render down to the level of the underlying masonry.

- Smooth over the vertical walls with a new layer of render 4 cm thick, reinforced with metal mesh fastened to the substrate with plugs. For the new layer of render, apply **MAPEGROUT T60** sulphate-resistant, fibre-reinforced thixotropic mortar or **MAPEGROUT BM** two-component mortar with a low modulus of elasticity. As a substitute for the reinforced render, the surface may be smoothed over with **PLANITOP HDM MAXI** two-component, fibre-reinforced, high-ductile mortar made from pozzolan-reaction binders in conjunction with **MAPEGRID G 120** or **MAPEGRID G 220** alkali-resistant, primed glass fibre mesh.

- Pipe-work and other elements which pass through the walls must be sealed with **MAPEPROOF SWELL** one-component, hydro-expanding paste for waterproof seals. Carefully demolish the area around the through elements, cracks and construction joints with suitable tools to a depth of at least 6 cm. To seal construction joints between old substrates and repairs, extrude **MAPEPROOF SWELL** around the through elements and then repair the substrate with **MAPEGROUT BM** mortar. When demolishing the areas, if water continues to seep through, stop the flow with **LAMPOSILEX** quick-setting and hardening hydraulic binder for stopping infiltration of water.

- On vertical walls and horizontal surfaces, apply two coats of **MAPELASTIC FOUNDATION** one after the other to form a strip at least 50 cm wide with a brush, a roller or by spray to form a layer at least 2 mm thick. Approximately 4 hours after applying the first layer in good weather, and in all cases only when the first layer has dried, the second layer may be applied.

WATERPROOFING STRUCTURES INSTALLED BELOW GROUND LEVEL

Horizontal surfaces

When the **MAPELASTIC FOUNDATION** is completely cured, apply the **MAPEPROOF** on the horizontal surfaces by positioning the underside (the dark side) of the geo-textile fabric on the substrate and the upper side of the fabric (the white side) facing upwards so it is visible. The edges must overlap by at least 10 cm. Fasten the sheets in place to the substrate with nails and **MAPEPROOF CD** polyethylene washers approximately every 50 cm. When laying the product around through elements (pillars, pipe-work, etc.) the sheets must be cut to shape so they fit perfectly around the elements, which must also be sealed with **IDROSTOP B25** (in certain cases, it may be necessary to extrude **MAPEPROOF SWELL** over the **IDROSTOP B25**). Make sure there are absolutely no creases when laying the sheets.

- Joints between **MAPEPROOF** and **MAPELASTIC FOUNDATION** must be sealed with **IDROSTOP B25** hydro-expanding bentonite jointing material, fixed to the surface with nails every 25 cm. As an alternative, **IDROSTOP** hydro-expanding rubber profile for waterproofing working joints up to a pressure of 5 atm may also be used.

- If there is a horizontal structure to which the new foundations may be anchored, the **MAPEPROOF** must be perforated so that metallic connectors may be cast in place. This operation means that the thickness of the new foundations may be lower, in that the old structure will act as ballast for the new one. **MAPEPROOF** must be perforated according to the results of structural calculations. Apart from the thickness of the new floor slab and walls, the structural analysis must also indicate the number per square metre and diameter of the metallic connectors which must be used on the horizontal surfaces (foundation pad) and vertical surfaces (walls). Anchorage of the connectors to the horizontal surfaces must be carried out by casting **EPOJET** super-fluid epoxy resin, while **ADESILEX PG1** two-component, thixotropic epoxy adhesive must be used for the vertical surfaces. The points in



Fig. 8.6h - Casting of the reinforced concrete floor slab, calculated to withstand the hydraulic lift from the groundwater



Fig. 8.7 - Infiltrations in correspondence with the construction joints in the reinforced concrete structure for a lift well

which the connectors pass through the sheets must be grouted with **MAPEPROOF MASTIC**.

- After carrying out the operations described above, position the steel reinforcement for the new reinforced concrete floor slab on the horizontal surfaces, at a suitable distance from the **MAPEPROOF** sheets using plastic spacers. These spacers allow the concrete to flow freely under and around the steel reinforcement and guarantee that the reinforcement is well covered. Then cast the reinforced concrete, the thickness of which must be sufficient to resist the hydraulic lift from the ground water.

8.2 WATERPROOFING A LIFT WELL AGAINST HYDRAULIC LIFT

Waterproofing a lift well against hydraulic lift (Fig. 8.7) may be carried out in one of three ways:

1. by applying a layer of water-repellent mortar made with **IDROSILEX** and **IDROSILEX PRONTO** on the vertical walls;
2. application of a waterproof coating with water-repellent mortar made with **IDROSILEX** on the horizontal surface and **MAPELASTIC FOUNDATION** on the vertical and horizontal surfaces;
3. application of **MAPEPROOF** on the horizontal surface in conjunction with **MAPELASTIC FOUNDATION** on the vertical surfaces.

With all three solutions, the construction joints, cracks and pipe-work and elements which pass through the concrete must firstly be sealed by applying **MAPEPROOF SWELL** one-component, hydro-expanding paste for waterproof seals. Carefully demolish the area around the through elements, cracks and construction joints with suitable tools to a depth of at least 6 cm. Extrude **MAPEPROOF SWELL** around the through elements and then repair the substrate with **MAPEGROUT T40** or **MAPEGROUT BM** mortar. When demolishing the areas, if water continues to seep through, stop the flow with **LAMPOSILEX** quick-setting and hardening hydraulic binder for stopping infiltration of water.

WATERPROOFING STRUCTURES INSTALLED BELOW GROUND LEVEL

The surfaces to be waterproofed must be perfectly clean and solid. Any gravel clusters must be removed and the vertical surfaces must be levelled off with **PLANITOP 400** quick-setting, compensated-shrinkage, thixotropic mortar for quick repairs on the surface of concrete, or with **PLANITOP 430** fine-grained, fibre-reinforced, compensated-shrinkage thixotropic mortar for repairing deteriorated concrete or products from the **MAPEGROUT** range. Then remove all dust and residues of previous operations with a mechanical brush, by sand-blasting or with high pressure water jets.

After preparing the substrate as described above, the waterproofing product may be applied as described below.

8.2.1 WATERPROOFING WITH OSMOTIC MORTAR

- After preparing the substrate as described above, wet the substrate until it is saturated with a dry surface, then apply **IDROSILEX PRONTO** waterproof osmotic cementitious mortar with a brush, trowel or by spray. Pay particular attention when applying the product on the fillet joint between the walls and horizontal surface and between adjacent walls, and make sure it penetrates into the substrate. Spread the **IDROSILEX PRONTO** on the vertical surfaces and form an overlap on the horizontal surface at least 30 cm wide. The product must form a layer at least 2-3 mm thick and the characteristics of the hardened layer make it suitable only for forming rigid waterproofing layers.

- Complete the waterproofing system by applying several layers of water-repellent mortar made with **IDROSILEX** in powder or liquid form, as described above. On the surface, spread bonding slurry made from **PLANICRETE**, synthetic latex rubber for cementitious mixes and the same amount of water, blended with the cement at a ratio of 1:3. Using the fresh on fresh technique, apply a 7-8 mm thick layer of mortar with a plastic consistency made from sand, cement and **IDROSILEX** according to the proportions in the Technical Data Sheet. After approximately one hour, before the substrate has completely



Fig. 8.8a – One of the phases of the installation of waterproof coating with water-repellent **IDROSILEX** mortar on the horizontal surface and **MAPELASTIC FOUNDATION** on the vertical and horizontal surfaces: spreading on bonding slurry



Fig. 8.8b – Screed made from sand, cement and **IDROSILEX**



Fig. 8.8c – Application of **EPORIP** in the fillet joints between horizontal and vertical surfaces and between adjacent walls



Fig. 8.8d – Making fillets on the **EPORIP** while still fresh with **MAPEGROUT BM**



Fig. 8.8e – Vertical walls and horizontal surfaces waterproofed with **MAPELASTIC FOUNDATION**



Fig. 8.8e – Application of **MAPELASTIC FOUNDATION**

hardened, install a 40 mm thick screed made from sand, cement and **IDROSILEX** according to the proportions in the Technical Data Sheet.

- The screed must be well compacted and smoothed over and must be cured for at least two days. Then apply a layer of **EPORIP** two-component, solvent-free epoxy adhesive on the fillet joints between the horizontal and vertical surfaces and between the adjacent walls. On the fresh **EPORIP**, form fillets with **MAPEGROUT BM** two-component mortar with a low modulus of elasticity.

8.2.2 WATERPROOFING WITH A COMBINED OSMOTIC MORTAR-FLEXIBLE CEMENTITIOUS MORTAR SYSTEM

- After preparing the substrate as described above, apply several layers of water-repellent mortar made with **IDROSILEX** in powder or liquid form, as described below. Spread a layer of bonding slurry on the surface (Fig. 8.8) made from **PLANICRETE** synthetic latex rubber for cementitious mixes and the same amount of water, blended with the cement at a ratio of 1:3. Using the fresh on fresh technique, apply a 7-8 mm thick layer of mortar with a plastic consistency made from sand, cement and **IDROSILEX** according to the proportions in the Technical Data Sheet. After approximately one hour, before the substrate has completely hardened, install a 40 mm thick screed made from sand, cement and **IDROSILEX** according to the proportions in the Technical Data Sheet.

- The screed must be well compacted and smoothed over and must be cured for at least two days. Then apply a layer of **EPORIP** two-component, solvent-free epoxy adhesive on the fillet joints between the horizontal and vertical surfaces and between the adjacent walls. On the fresh **EPORIP**, form fillets with **MAPEGROUT BM** two-component mortar with a low modulus of elasticity. After completing the cycle, apply two coats of **MAPELASTIC FOUNDATION** with a brush or roller on all the vertical and horizontal surfaces to form a layer at least 2 mm thick.

WATERPROOFING STRUCTURES INSTALLED BELOW GROUND LEVEL

Approximately 4 hours after applying the first layer, and in all cases only when the first layer has dried, the second layer may be applied.

8.2.3 WATERPROOFING WITH A COMBINED BENTONITE-FLEXIBLE CEMENTITIOUS MORTAR SYSTEM

- After preparing the substrate as described above, apply two coats of **MAPELASTIC FOUNDATION** on the horizontal surface and a strip at least 30 cm wide on the vertical surfaces with a brush or roller to form a layer at least 2 mm thick. Approximately 4 hours after applying the first layer, and in all cases only when the first layer has dried, the second layer may be applied.

- Line the horizontal surfaces with **MAPEPROOF** by positioning the underside (the dark side) of the geo-textile fabric on the substrate and on the vertical walls and the upper side of the fabric (the white side) facing upwards so it is visible. The edges must overlap by at least 10 cm. Fasten the sheets in place to the substrate with nails and **MAPEPROOF CD** polyethylene washers approximately every 50 cm on horizontal surfaces and every 30 cm on vertical surfaces. When laying the product around through elements, the sheets must be cut to shape so they fit perfectly around the elements, which must also be sealed with **IDROSTOP B25** (in certain cases, it may be necessary to extrude **MAPEPROOF SWELL** over the **IDROSTOP B25**). Make sure there are absolutely no creases when laying the sheets.

- Joints between **MAPEPROOF** and **MAPELASTIC FOUNDATION** must be sealed with **IDROSTOP B25** hydro-expanding bentonite jointing material, fixed to the surface with nails every 25 cm. As an alternative, **IDROSTOP** hydro-expanding rubber profile for waterproofing working joints up to a pressure of 5 atm may also be used.

- To join the steel reinforcement in the new reinforced concrete floor slab with the reinforcement in the old one, the **MAPEPROOF** sheets

must be perforated according to the results of structural calculations. Apart from the thickness of the new floor slab, the structural analysis must also indicate the number per square metre and diameter of the metallic connectors which must be used on the horizontal surfaces. The connectors must then be cast in place with **EPOJET** super-fluid epoxy resin. The points in which the connectors pass through the sheets must be grouted with **MAPEPROOF MASTIC**.

- After carrying out the operations described above, position the steel reinforcement for the new reinforced concrete floor slab on the horizontal surfaces, at a suitable distance from the **MAPEPROOF** sheets using plastic spacers. These spacers allow the concrete to flow freely under and around the steel reinforcement and guarantee that the reinforcement is well covered. Then cast the reinforced concrete, the thickness of which must be sufficient to resist the hydraulic lift from the ground water.

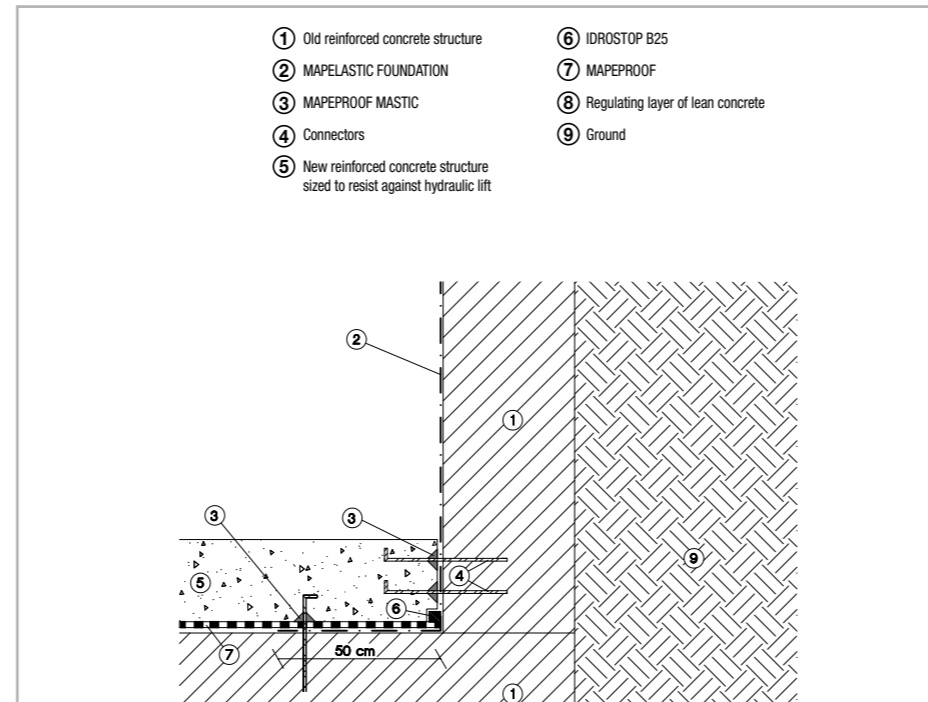

Fig. 8.9 - Detailed layout of relining the inside of a lift well by applying MAPEPROOF on the horizontal surface and MAPELASTIC FOUNDATION on the vertical surface: fillet joint between the floor slab and retaining wall

Bibliography

1. P. Colombo, F. Colleselli: "Elements of Geotechnics". Third edition. 2004. Printed by Zanichelli.
2. Varisco Wellpoint, "Draining ground with the wellpoint system".

**WATERPROOFING STRUCTURES
INSTALLED BELOW GROUND LEVEL**



**CENTRAL STATION
Milan - Italy**

Waterproofing the former underground car-park area, now used as an archive, with **MAPEPROOF** and **IDROSTOP B25**

**NIKE STORE
San Benedetto del Tronto
Italy**

Waterproofing structures below ground level with **MAPEPROOF**, **MAPELASTIC FOUNDATION**, **IDROSTOP B25**, **MAPEPROOF SWELL** and **LAMPOSILEX**



