

20 24



Catalogue_01

20
24



Catalogue_01



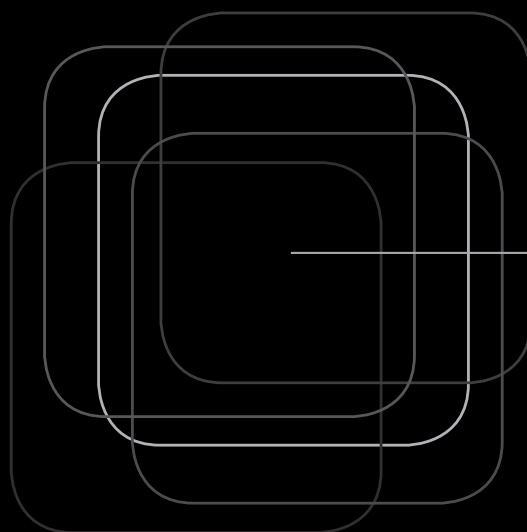



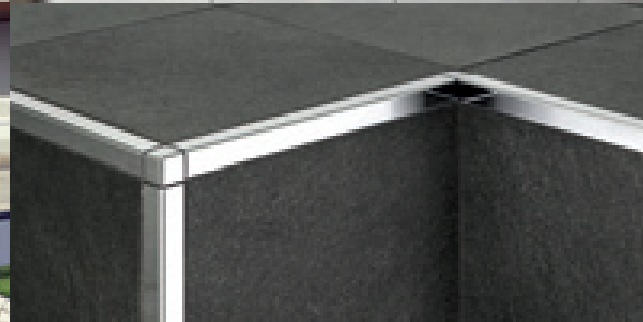
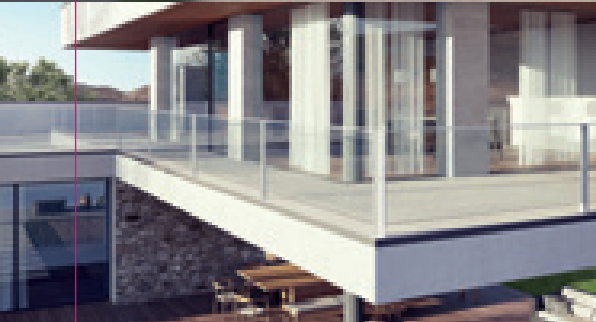
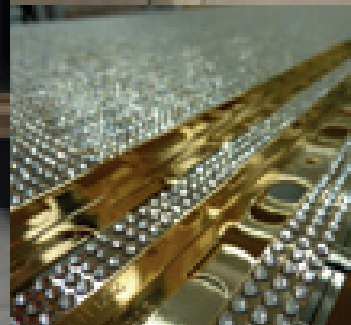
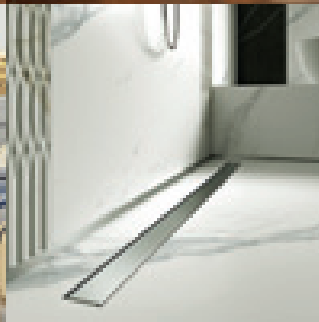
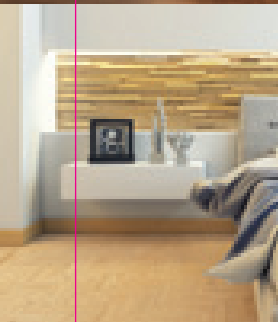
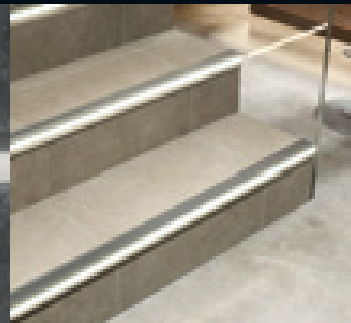





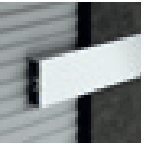







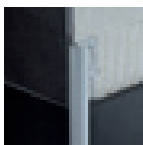

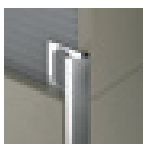





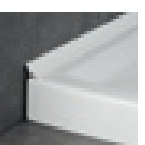
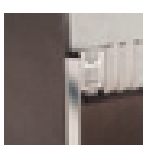

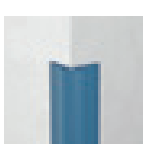

Design is our best profile.





Index

external corners profiles		CERFIX® PROANGLE Q page 18	listellos and decorative profiles		CERFIX® PROLIST page 50	linear drains and bathroom systems		PP DRAIN AQUA page 68	
		CERFIX® PROANGLE page 26			METAL LINE AF - M DESIGN page 51			THIN DRAIN page 73	
		CERFIX® PROTRIM IP page 31			CERFIX® PROLIST-X DESIGN page 51			SLIM DRAIN page 75	
		CERFIX® PROTRIM page 32			CERFIX® PRODECOR - C DESIGN page 52-53			SMART DRAIN page 77	
		CERFIX® PROTRIM N page 35			CERFIX® PROSTYLE - C DESIGN page 52-53			Q DRAIN page 79	
		CERFIX® PROANGLE F page 40						GLASS PROFILE page 82	
		CERFIX® PROANGLE AX - M DESIGN page 41	internal corners profiles		CERFIX® PROROUND M page 56			SANIBORD page 90	
		CERFIX® PRONIVEL M page 41			CERFIX® PROROUND P page 59				
		PROCORNER M page 42			CERFIX® PROROUND M GIC/ page 60		profiles for floors of same height		CERFIX® PROANGLE page 94
		PROCORNER P page 44			CERFIX® PROINT page 60-61				CERFIX® PROANGLE B page 95
	CERFIX® PROBORD page 46			PROROUND B page 62		CERFIX® PROANGLE FLEX page 96			
	CERFIX® PROTOP page 47					CERFIX® PRODECOR DJ page 97			



CERFIX®
PRODECOR DJ
FLEX
page 97

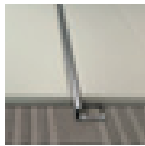

CERFIX®
PRODECOR
page 97



CERFIX®
PROSTYLE
page 98



PROJOINT U
page 99



PROJOINT
page 99

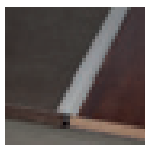

PROJOINT T
page 100



PROJOINT R
page 102



PROJOINT M
page 102



PROCLASSIC R
page 103



PROCLASSIC F
page 106



CERFIX®
PRONIVEL P
page 111



CERFIX®
PRONIVEL L
page 112



CERFIX®
PRONIVEL PB
page 112



CERFIX®
PRONIVEL PL
page 113



CERFIX®
PRONIVEL M
page 113



PROLEVEL
HIGH
page 114



PROLEVEL
MEDIUM
page 116



PROLEVEL
THIN
page 117

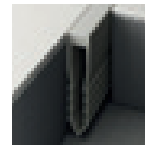

CERFIX®
PROJOINT
DIL NF
page 121



CERFIX®
PROJOINT DIL
NAN
page 122



CERFIX®
PROJOINT DIL
NPAN
page 122



CERFIX®
PROJOINT DIL
NIN
page 123



CERFIX®
PROJOINT DIL
NIL
page 123



CERFIX®
PROJOINT DIL
NTA - NTI - NTO
page 124



CERFIX®
PROJOINT DIL
STA - STI
page 124



CERFIX®
PROJOINT DIL
NZA
page 125



CERFIX®
PROJOINT DIL
NZS
page 125



CERFIX®
PROJOINT DIL
PBE
page 126



CERFIX®
PROJOINT DIL
PBH
page 127



CERFIX®
PROJOINT DIL
PAS
page 127

movement joints



CERFIX®
PROJOINT
DIL NE
page 120



CERFIX®
PROJOINT
DIL NJ
page 120



CERFIX®
PROJOINT
DIL NL
page 121

profiles for floors of different height



CERFIX®
PRONIVEL N
page 110

Index



CERFIX®
PROJOINT DIL
PHDE
page 128



CERFIX®
PROJOINT DIL
PFFE
page 128



CERFIX®
PROCOVER
FLEX
page 129

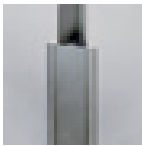

CERFIX®
PROCOVER FIX
page 129



CERFIX®
PROCOVER
page 130



CERFIX®
PROTEC CPEV
- CPEI
page 140



CERFIX®
PROTEC CPNV
page 142

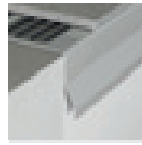

CERFIX®
PROTEC CPBV
page 143



CERFIX®
PROTEC CPHA
- CPHV
page 144



CERFIX®
PROTEC CPLB
- CPLV
page 145

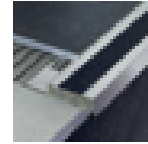

CERFIX®
PROSTEP SIX
page 151

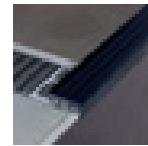

CERFIX®
PROSTEP SP
page 152



CERFIX®
PROSTEP SA
- SB
page 152



PROTECT
page 154



SAFETY-STEP
page 162



PROSTAIR
page 164

profiles for balconies and terraces



CERFIX®
PROTEC CPCV
- CPCI
page 134

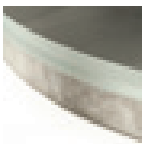

CERFIX®
PROTEC CPCVF
page 134



CERFIX®
PROTEC
CPCV/30/
page 136



CERFIX®
PROTEC
CPCVD/30/
page 137



CERFIX®
PROTEC CPGV
page 138

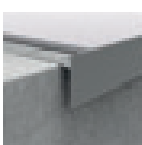

CERFIX®
PROTEC CPQV
page 139

stair nosing profiles



CERFIX®
PROSTEP SGA -
SGI - SGN - SGK
page 148



CERFIX®
PROSTEP SMA
- SM
page 148



CERFIX®
PROTRIM IP
page 149



CERFIX®
PROSTEP SNG
- SN
page 149



CERFIX®
PROSTEP SAR
- SIR
page 150

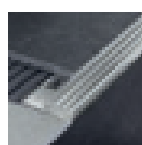

CERFIX®
PROSTEP SIS
page 151

profiles for wooden, laminated and LVT floors



UNISYSTEM
PLUS
page 170

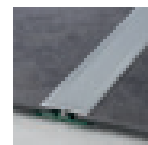

PROFIX THIN
page 176



PRESTOWOOD
page 178



TERMINAL RC
page 181



TERMINAL RC
FLEX
page 181



ALFIX 616
page 182



ALFIX 46
page 183



CERFIX®
PROJINT DIL
page 184



CERFIX®
PRONIVEL PB
page 184-185



CERFIX®
PROJINT T
page 185



CERFIX®
PROSTEP
page 186



PROTECT
page 186



CERFIX®
PROTRIM
page 187



CERFIX®
PROANGLE
page 187

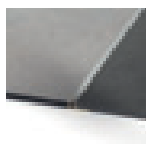

CERFIX®
PROANGLE Q
page 187



CERFIX®
PROROUND M
page 188



CERFIX®
PROINT
page 188

metal line



METAL LINE 90
page 194



METAL LINE 90
TREND COLOR
page 194

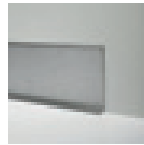

METAL LINE
790
page 196



METAL LINE 92
page 197



METAL LINE 93
page 197



METAL LINE 89
page 198



METAL LINE 89
TREND COLOR
page 198

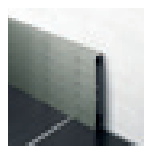

METAL LINE 89
I DESIGN
page 199

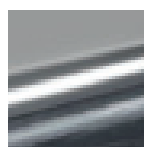

PROLIGHT
METAL LINE 89
page 199



METAL LINE
89/613
page 200



METAL LINE
105
page 201



METAL LINE
87 - 88
page 202

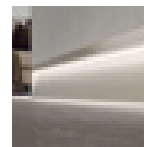

PROLIGHT
METAL LINE S
SKL/2
page 203



METAL LINE AF
- M DESIGN
page 203

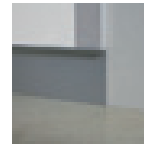

METAL LINE
100
page 204



METAL LINE
101
page 204

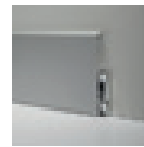

METAL LINE
95 - 94
page 205



METAL LINE 98
page 206



METAL LINE
97/4
page 207

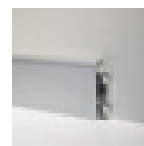

METAL LINE
97/7
page 208

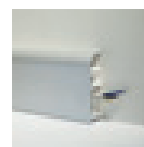

METAL LINE
97/8
page 209

pvc line

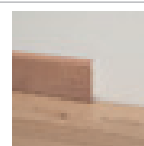

PVC LINE 8605
page 212



PVC LINE 8606
page 212

Index

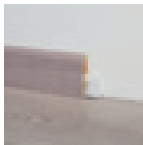

PVC LINE 8608
page 213



PVC LINE 8615
page 214



PVC LINE 8616
page 214



PVC LINE 8613
page 215



PVC LINE 8612
page 216



PVC LINE 8614
page 216



PVC LINE 8600
page 217

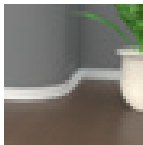

PVC LINE 8181
page 217

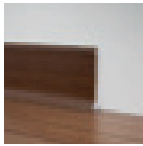

PVC LINE 8596
- 8598
page 218



PVC LINE 8580
- 8582
page 218



PVC LINE 8602
page 219



PVC LINE 8603
page 220

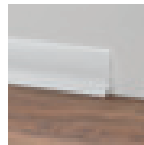

PVC LINE 8607
page 221



PVC LINE 148 -
172 - 173
page 222



PVC LINE 170 -
169 - 171
page 223



PROLIGHT
METAL LINE
87/88
page 233

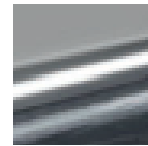

PROLIGHT
METAL LINE 89
page 234



ELECTRICAL
COMPONENTS
page 236

prolight

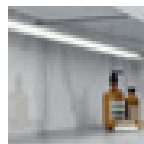

PROLIGHT
PROLIST LLA
- LLB
page 226



PROLIGHT
PROLIST TLA
- CLA
page 227

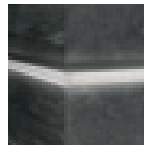

PROLIGHT
PROLIST Q LQL
page 228

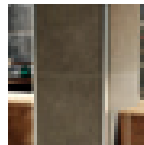

PROLIGHT
PROANGLE Q
ZQAL
page 229



PROLIGHT
PROSTEP
SGA/11L
page 230

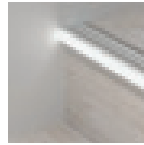

PROLIGHT
PROTECT G/9/F
page 230



PROLIGHT
PROTECT
126/L/F
page 231

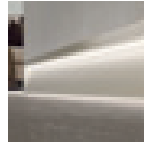

PROLIGHT
METAL LINE S
SKL/2
page 232

technical
entrance
mats

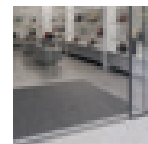

PROMAT
page 241

accessories
for
installation



PROTILER
page 245



FIX LEVEL
page 246

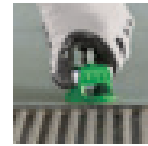

KLIC LEVEL
page 247



SPACERS
WEDGES
page 248



ACCESSORIES
FOR
INSTALLATION
page 249



PROFLEX
MACHINE
page 250

DIY profiles



DIY PROFILES
page 252

merchandising
for the point
of sale













MERCHANDISING
FOR THE POINT
OF SALE
page 260





index by
item

page 272

stainless steel

-  **SS**
polished stainless steel
AISI 304 DIN 1.4301
-  **SS3**
polished stainless steel
AISI 316 DIN 1.4404
-  **SS0**
polished stainless steel
AISI 430 DIN 1.4016
-  **SSP**
superpolished stainless steel
AISI 304 DIN 1.4301
-  **SSS**
brushed stainless steel
AISI 304 DIN 1.4301
-  **SSB**
sandblasted stainless steel
AISI 304 DIN 1.4301
-  **SSS3** brushed
stainless steel AISI
316 DIN 1.4404
-  **CSS3** chromium-plated
stainless steel AISI
316 DIN 1.4404
-  **SSS0**
brushed stainless steel
AISI 430 - DIN 1.4016
-  **BM** matt black RAL 9005
colour-coated stainless
steel AISI 304 DIN 1.4301

brass

-  **BN**
natural
-  **BP**
polished
-  **BCP**
plated polished
-  **BCG**
24kt gold plated



aluminium

-  **AN**
natural

anodised aluminium

-  **AS**
silver
-  **AG**
gold
-  **ASG**
sand gold
-  **AT**
titanium
-  **AB**
bronze
-  **ABE**
bronze elox
-  **ABL**
black

anodised aluminium X Design - I Design

-  **APX**
platinum
-  **ATX**
titanium
-  **ABX**
brown

-  **ABBX**
dark brown

-  **ACX**
carbon

bright polished aluminium

-  **ABPS**
silver

-  **ABPG**
gold

-  **ABPT**
titanium

-  **ABPC**
copper

bright brushed aluminium

-  **ABSS**
silver

-  **ABSG**
gold

-  **ABST**
titanium

-  **ABSC**
copper

-  **ABSB**
black

bright scratched aluminium

-  **ABBS**
silver

colour-coated aluminium

-  **AC RAL 9003**
matt white

-  **AC RAL 9003**
white

-  **AC RAL 9010**
matt white

-  **AC RAL 9010**
polished white

-  **AC RAL 8019**
dark brown

-  **AC RAL 7038**
ash grey

-  **AC RAL 7038**
ash grey embossed

-  **AC RAL 9006**
metal grey

-  **AC RAL 9007**
aluminium grey

colour-coated aluminium Trend Color

-  **AC anthracite grey**

-  **AC rust**

-  **AC ancient grey**

-  **AC beige**

-  **AC sand**

-  **AC greige**

-  **AC stone**

-  **AC grey**

-  **AC bronze**

-  **AC dark brown**

-  **AC white stone**

-  **AC black stone**

-  **AC concrete white**

-  **AC concrete graphite**

-  **AC concrete smoke**

-  **AC concrete mud**

-  **AC concrete sand**

-  **AC metal dark**

-  **AC metal light**

-  **AC solid white**

decors Alcom® Plus

-  02

-  05

-  08

-  10

-  11

-  12

-  13

-  14

-  18

-  19

-  20

-  25

-  26

-  31

-  32

-  34

-  35

-  36

-  37

-  38

-  39

-  40

-  41

-  42

-  43

-  44

-  47

-  65

-  71

-  72

-  73

-  74

-  76

-  77

-  78

-  79

-  80

-  81

-  89

-  91

-  92

-  93

-  94

	95
	351
	363
	372
	490
	560
	580
	590
	665
	670
	951
	975
	1003
	1006
	1009
	1012
	1021
	1024
	1030
	1033
	1036
	1042
	1045
	1051
	1054
	1057
	1060
	1063
	1066
	1069

	1081
	1084
	1090
	1093
	1096
	1099
	1102
	1105
	1108
	1111
	1202
	1203
	1204
	1205
	1206
	1207
	1208
	1209
	1210
	1211
	1212
	1213
	1214
	1215
	1216
	1217
	96 - embossed white RAL 9010
	97 - embossed black RAL 9005
	99 - brushed silver
	100 - brushed steel

PVC

	code 400 snow white
	code 402 white
	code 404 9001 cream white
	code 406 RAL 1015 - ivory
	code 408 RAL 1019 - beige grey
	code 410 RAL 7030 - stone grey
	code 412 RAL 7038 - ash grey
	code 414 RAL 7035 - light grey
	code 416 anthracite
	code 418 blue
	code 420 pastel blue
	code 422 light green
	code 424 RAL 3002 - red
	code 426 RAL 9005 - black
	code 428 RAL 1023 - yellow
	code 430 pastel pink
	code 432 beige bahama
	code 434 peach
	code 436 caramel
	code 438 brown
	code 440 dark brown
	code 442 coral red
	code 444 raw sienna
	code 446 terracotta

foam PVC

	decor 518
	decor 520
	decor 524
	decor 525

	decor 528
	decor 530
	decor 531
	decor 532
	decor 533
	decor 534
	decor 536
	decor 540
	decor 542
	decor 544
	decor 545
	decor 555 white
	decor 556 light grey
	decor 557 black
	decor 558 anthracite
	decor 559 grey
	decor 561 yellow
	decor 562 green
	decor 563 light blue
	decor 564 red



external corners profiles

A line dedicated to the protection and finishing of outside corners of the wall tiles. Profiles are suitable for any type of environment for the variety of finishes available, matching perfectly with all types of ceramics and giving character to the compositions and linearity.



Proangle Q in aluminium is a line of universal profiles with square shape, specially designed to edge and protect the external corners of ceramic coverings, that can be also used for finishing worktops and platforms. ZQVNH/ boasts the certified antibacterial technology (in compliance with ISO 22196:2011 standards) which reduces the presence of the most dangerous bacteria up to 99%, thus assuring the best hygiene over time.



ZQBN/10 bright polished silver aluminium



PROANGLE Q

length = 270 cm - pack 20 pcs

ART.	finishing	4,5	6	8	9	10	11	12,5	
ALUMINIUM									
	silver anodised		88772	88875	88876	88877	88878	88879	88880
ZQAN/	<i>euro/m</i>								
	titanium anodised		88902	88903	88904	88905	88906	88907	88908
ZQAN/	<i>euro/m</i>								
	black anodised		-	-	89205	-	89206	89207	89208
ZQAN/	<i>euro/m</i>								
ZQBN/	bright polished silver		88816	88919	88920	88921	88922	88923	88924
ZQBN/	<i>euro/m</i>								
	bright polished gold		88933	-	88935	-	88937	-	88939
ZQBN/	<i>euro/m</i>								
	bright polished titanium		88956	88964	88966	88968	88970	88972	88974
ZQBRN/	<i>euro/m</i>								
	bright polished copper		-	-	-	-	88969	-	88971
ZQBRN/	<i>euro/m</i>								
	bright brushed silver		88981	88982	88983	-	88985	88986	88987
ZQBSN/	<i>euro/m</i>								
	bright brushed gold		88997	-	88999	-	89001	-	89003
ZQTMN/	<i>euro/m</i>								
	bright brushed titanium		89013	89014	89015	-	89017	-	89019
ZQBSN/	<i>euro/m</i>								
	bright brushed copper		-	-	89031	-	89033	-	89035
ZQBSN/	<i>euro/m</i>								
	bright brushed black		-	-	-	-	89209	89210	89211
ZQBSN/	<i>euro/m</i>								
	bright scratched silver		89061	-	89063	-	89065	-	89067
ZQAGN/	<i>euro/m</i>								
COLOUR-COATED ALUMINIUM									
	colour-coated matt white RAL 9003		-	-	89200	-	89202	89203	89204
ZQVN/	<i>euro/m</i>								
	colour-coated white RAL 9003		89077	89076	89079	-	89081	89078	89083
ZQVN/	<i>euro/m</i>								
ANTIBACTERIAL COLOUR-COATED ALUMINIUM									
ZQVNH/	colour-coated white RAL 9003		-	-	89080	-	89082	-	89084
ZQVNH/	<i>euro/m</i>								

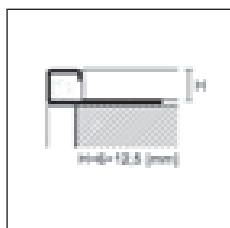
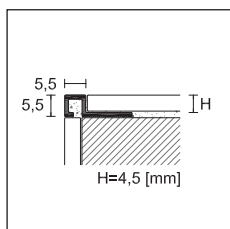

ZQAN/10 black anodised aluminium

Complete the article code with H measure (for example ZQAN/ for H=8 becomes ZQAN/8)

Items ZQVN available in different colours on demand minimum quantity 540 meters for colour



ZQAN/ /EI
silver anodised
aluminium

PROANGLE Q - OUTSIDE / INSIDE CORNERS / END CAPS

pack 5 pcs		H							
ART.	finishing		4,5	6	8	9	10	11	12,5
ALUMINIUM									
ZQAN/ /EI	silver anodised		88809	88882	88883	88884	88885	88886	88887
	titanium anodised		88910	88911	88912	88913	88914	88915	88916
<i>euro/pc</i>									
ZQAN/ /EI	black anodised		-	-	89223	-	89224	89225	89226
			-	-		-			
<i>euro/pc</i>									
ZQBN/ /EI	bright polished silver		88829	88926	88927	88928	88929	88930	88931
	bright polished gold		88941	-	88943	-	88945	-	88947
ZQVN/ /EI	colour-coated matt white RAL 9003		-	-	89192	-	89194	89195	89196
	colour-coated white RAL 9003		89085	89086	89087	-	89089	89088	89091
<i>euro/pc</i>									
ZQBN/ /EI	bright polished titanium		88976	88978	88980	88984	88988	88992	88996
ZQBRN/ /EI	bright polished copper		-	-	-	-	88977	-	88979
ZQBSN/ /EI	bright brushed silver		88989	88990	88991	-	88993	88994	88995
	bright brushed gold		89005	-	89007	-	89009	-	89011
ZQTMN/ /EI	bright brushed titanium		89021	89022	89023	-	89025	-	89027
ZQBRSN/ /EI	bright brushed copper		-	-	89039	-	89041	-	89043
ZQBSN/ /EI	bright brushed black		-	-	-	-	89227	89228	89229
<i>euro/pc</i>									
ZQAGN/ /EI	bright scratched silver		89069	-	89071	-	89073	-	89075
				-		-		-	
<i>euro/pc</i>									

no partial packaging

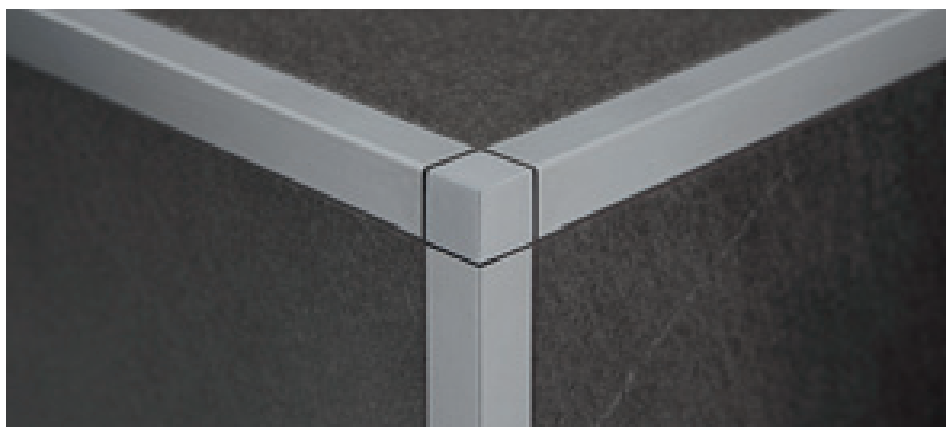

ZQAN/10 + ZQAN/10/EI silver anodised aluminium

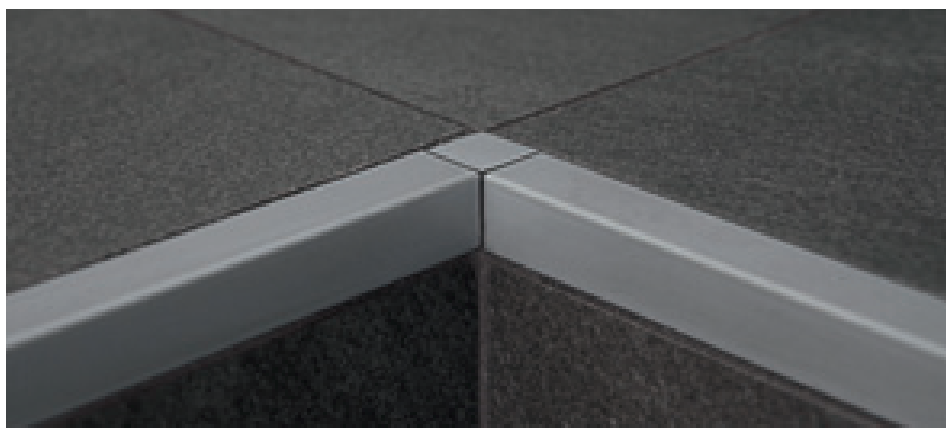

ZQAN/10 + ZQAN/10/EI silver anodised aluminium

Complete the article code with H measure
(for example ZQAN/ /EI for H=8 becomes
ZQAN/8/EI)

cerfix® proangle Q

Colour-coated aluminium Trend Color Stone: modern finishes with neutral but warm and soft shades which reproduce the heterogeneity of stone thanks to a rough texture.

Colour-coated aluminium Trend Color Concrete: six original cement-effect finishes that recall the typical metropolis colours by revisiting them from a more refined point of view.

Colour-coated aluminium Trend Color Metal: two special metal tonalities which reproduce the iridescent nature of metals.



ZQVN/10 stone colour-coated aluminium

PROANGLE Q - TREND COLOR

length = 270 cm - pack 20 pcs

ART.	finishing	H			
		8	10	11	12,5

COLOUR-COATED ALUMINIUM

TREND COLOR STONE

dark brown		89360	89310	89311	89312
anthracite grey		89093	89095	89106	89097
ancient grey		89362	89220	89221	89222
grey		89363	89290	89291	89292
rust		89094	89096	89107	89098
bronze		89365	89300	89301	89302
stone		89366	89280	89281	89282
greige		89367	89270	89271	89272
sand		89368	89260	89261	89262
beige		89369	89250	89251	89252
white stone		89370	89320	89321	89322
black stone		89371	89330	89331	89332

TREND COLOR CONCRETE

concrete white		-	89131	89161	89181
concrete graphite		-	89132	89162	89182
concrete smoke		-	89133	89163	89183
concrete mud		-	89134	89164	89184
concrete sand		-	89135	89165	89185
solid white		-	89138	89168	89188

TREND COLOR METAL

metal dark		-	89136	89166	89186
metal light		-	89137	89167	89187

euro/m

individually packed - Other heights with TREND COLOR finishes are available upon request, with a minimum of 540 meters.

TREND
COLOR

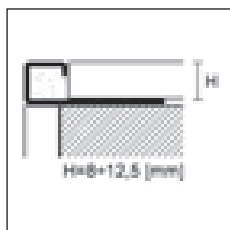

ZQVN/



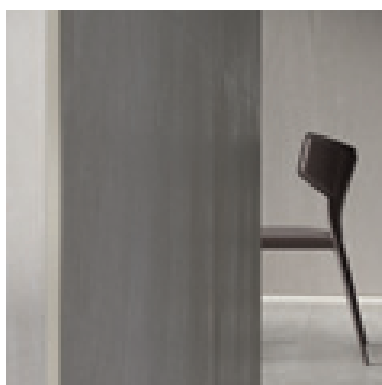

















ZQVN/



ZQVN/10 concrete white colour-coated aluminium

Complete the article code with H measure (for example ZQVN/ for H=10 becomes ZQVN/10).

PROANGLE Q - TREND COLOR - OUTSIDE / INSIDE CORNERS / END CAPS

pack 5 pcs		H				
ART.	finishing	8	10	11	12,5	
COLOUR-COATED ALUMINIUM						
TREND COLOR STONE						
	dark brown		89380	89303	89304	89305
	anthracite grey		89100	89102	89108	89104
	ancient grey		89382	89213	89214	89215
	grey		89383	89283	89284	89285
	rust		89101	89103	89109	89105
	bronze		89385	89293	89294	89295
	stone		89386	89273	89274	89275
	greige		89387	89263	89264	89265
	sand		89388	89253	89254	89255
	beige		89389	89243	89244	89245
ZQVN/ /EI	white stone		89390	89340	89341	89342
	black stone		89391	89350	89351	89352
TREND COLOR CONCRETE						
	concrete white		-	89392	89402	89410
	concrete graphite		-	89394	89403	89411
	concrete smoke		-	89395	89404	89412
	concrete mud		-	89396	89405	89413
	concrete sand		-	89397	89406	89414
	solid white		-	89400	89409	89417
TREND COLOR METAL						
	metal dark		-	89398	89407	89415
	metal light		-	89399	89408	89416
euro/pc						



ZQVN/ /EI
sand colour-coated
aluminium

no partial packaging

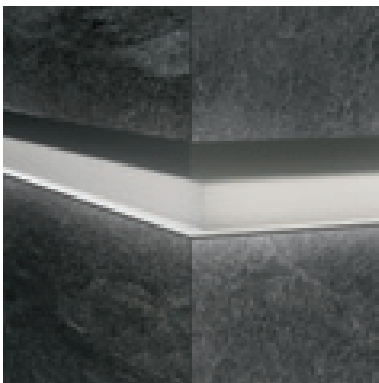

LED-light profiles and skirting boards with Trend Color finishes on page 228 and 232.



ZQVN/10 Trend Color finishes

Complete the article code with H measure (for example ZQVN/ /EI per H = 10 becomes ZQVN/10/EI).

external corners profiles

cerfix® proangle Q

In anodised aluminium, X Design is characterized by a special scratched finish and original colours that allow different chromatic combinations, created for interior designers and architects by following the latest trends of modern design.



ZQAND/10 brown anodised aluminium



PROANGLE Q - X DESIGN

length = 270 cm - pack 20 pcs

		H			
ART.	finishing	8	10	12,5	
ANODISED ALUMINIUM					
ZQAND/	platinum		31110	31112	31114
	titanium		31120	31122	31124
	brown		31130	31132	31134
	dark brown		31140	31142	31144
	carbon		31150	31152	31154
<i>euro/m</i>					

individually packed

PROANGLE Q - X DESIGN - OUTSIDE / INSIDE CORNERS / END CAPS

pack 5 pcs

		H			
ART.	finishing	8	10	12,5	
ANODISED ALUMINIUM					
ZQAND/ EI	platinum		31160	31162	31164
	titanium		31170	31172	31174
	brown		31180	31182	31184
	dark brown		31190	31192	31194
	carbon		31200	31202	31204
<i>euro/pc</i>					

no partial packaging

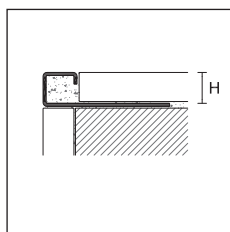

ZQAND/



ZQAND/ EI
brown
anodised
aluminium



Complete the article code with H measure
(for example ZQAND/ for H=8 becomes
ZQAND/8)

Proangle Q in stainless steel is a line of universal profiles with square shape, specially designed to edge and protect the external corners of ceramic coverings.

They are also particularly suitable for the edging and the protection of floors and steps in different materials, such as ceramic, stone, wood and resins, and can be also used for finishing worktops and platforms.

Stainless steel makes the profile particularly resistant to chemical and atmospheric agents. The AISI 316 DIN 1.4404 quality offers superior resistance to corrosion and is therefore recommended for applications in areas subject to greater chemical stress, such as swimming pools and food industries, and coastal areas.



ZQINP/10 sandblasted stainless steel AISI 304-DIN 1.4301

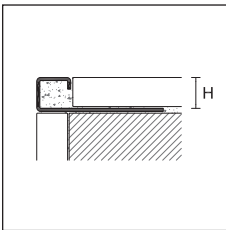

PROANGLE Q

length = 270 cm - pack 20 pcs

ART.	finishing		6	8	9	10	11	12,5	15
STAINLESS STEEL									
ZQIN/	stainless steel AISI 304 - DIN 1.4301		90049	90050	90051	90052	90053	90054	90055
	<i>euro/m</i>								
ZQINS/	brushed stainless steel AISI 304 - DIN 1.4301		90100	90101	90102	90103	90104	90105	90106
ZQINP/	sandblasted stainless steel AISI 304 - DIN 1.4301		90130	90131	90132	90133	90134	90135	90136
	<i>euro/m</i>								
ZQINX/	stainless steel AISI 316 - DIN 1.4404		-	90107	-	90109	-	90111	-
	<i>euro/m</i>		-	-	-	-	-	-	-

individually packed - ZQIN/15, ZQINS/15 and ZQINP/15 packaging of 10 pcs

PROANGLE Q - OUTSIDE / INSIDE CORNERS / END CAPS

pack 5 pcs

ART.	finishing		6	8	9	10	11	12,5	15
STAINLESS STEEL									
ZQIN/ /EI	stainless steel AISI 304 - DIN 1.4301		90064	90065	90066	90067	90068	90069	90070
	<i>euro/pc</i>								
ZQINS/ /EI	brushed stainless steel AISI 304 - DIN 1.4301		90112	90113	90114	90115	90116	90117	90118
ZQINP/ /EI	sandblasted stainless steel AISI 304 - DIN 1.4301		90137	90138	90139	90140	90141	90142	90143
	<i>euro/pc</i>								
ZQINX/ /EI	stainless steel AISI 316 - DIN 1.4404		-	90119	-	90121	-	90123	-
	<i>euro/pc</i>		-	-	-	-	-	-	-
METAL									
ZQIM/ /EI	polished stainless steel		-	90092	90093	90094	90095	90096	-
	<i>euro/pc</i>		-	-	-	-	-	-	-
ZQIMS/ /EI	brushed steel		-	90152	90153	90154	90155	90156	-
	<i>euro/pc</i>		-	-	-	-	-	-	-
ZQIMP/ /EI	sandblasted steel		-	90162	90163	90164	90165	90166	-
	<i>euro/pc</i>		-	-	-	-	-	-	-

no partial packaging for ZQIM/ /EI, ZQIMS/ /EI and ZQIMP/ /EI



ZQIN/ /EI stainless steel AISI 304 - DIN 1.4301



ZQIN/10/EI stainless steel AISI 304 - DIN 1.4301

Complete the article code with H measure (for example ZQIN/ for H=8 becomes ZQIN/8)

external corners profiles

cerfix® proangle Q

Proangle Q in polished brass is classic and modern at the same time and can be easily combined to handles, taps and other furniture accessories of the same material and finish.

The chromium-plated version stands out for its brilliance and is perfect as decorative element in spaces characterized by elegance and attention to details.



ZQKN/10 chromium-plated brass

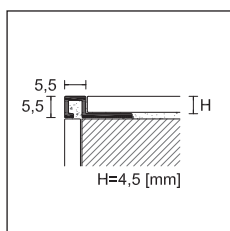

PPDESIGN

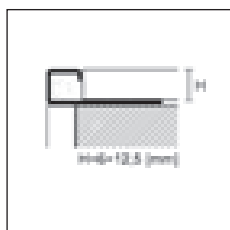

ZQKN/ EI
chromium-plated
brass

PROANGLE Q

length = 270 cm - pack 20 pcs

ART.	finishing	4,5	8	H	10	11	12,5
------	-----------	-----	---	---	----	----	------

POLISHED BRASS

ZQLN/	polished		90022	90056	90057	90063	90058
-------	----------	--	-------	-------	-------	-------	-------

euro/m

CHROMIUM-PLATED BRASS

ZQKN/	chromium plated		88870	90059	90060	90074	90061
-------	-----------------	--	-------	-------	-------	-------	-------

euro/m

individually packed - ZQKN/12,5 packaging of 10 pcs

PROANGLE Q - OUTSIDE / INSIDE CORNERS / END CAPS

length = 270 cm - pack 5 pcs

ART.	finishing	4,5	8	H	10	11	12,5
------	-----------	-----	---	---	----	----	------

BRASS

ZQLN/ EI	polished		90062	90071	90072	90075	90073
----------	----------	--	-------	-------	-------	-------	-------

euro/pc

ZQKN/ EI	chromium plated		88872	90077	90083	90085	90087
----------	-----------------	--	-------	-------	-------	-------	-------

euro/pc

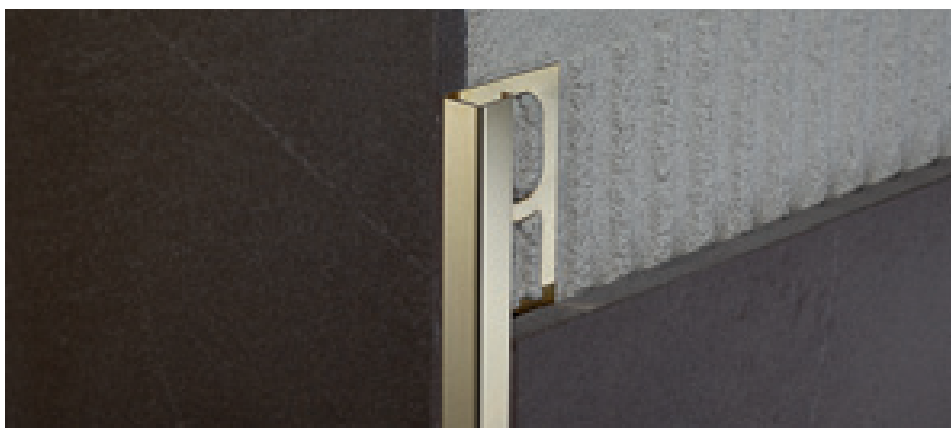

ZQLN/10 polished brass

Complete the article code with H measure
(for example ZQLN/ for H=8 becomes ZQLN/8)

Proangle Q in coextruded PVC is a line of universal profiles with square shape, specially designed to edge and protect the external corners of ceramic coverings. Thanks to the special section with soft PVC inserts, these profiles absorb the micro-movements that discharge on the corner due to the tension of the wall coverings.



ZQP/8 white PVC

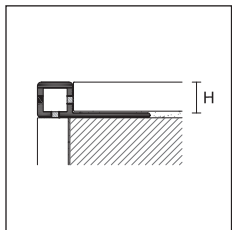









ZQP/



ZQP/8 beige bahama PVC

PROANGLE Q

length = 270 cm

		H				
ART.	finishing	6	8	10	12,5	
CO-EXTRUDED PVC						
	white		80800	80801	80802	80803
	cream white RAL 9001		80804	80805	80806	80807
	ivory RAL 1015		80808	80809	80810	80811
	beige grey RAL 1019		80812	80813	80814	80815
ZQP/	stone grey RAL 7030		80816	80817	80818	80819
	light grey RAL 7035		80820	80821	80822	80823
	anthracite		80824	80825	80826	80827
	beige bahama		80832	80833	80834	80835
	brown		80836	80837	80838	80839

pack 20 pcs
euro/m

pack 80 pcs
euro/m









pack 100 pcs
euro/m

no partial packaging

to order the pack of 80 and 100 pcs, mark /80 or /100 after the article code (for example, code 80800 becomes 80800/100)

PROANGLE Q - OUTSIDE / INSIDE CORNERS / END CAPS

pack 12 pcs

		H				
ART.	finishing	6	8	10	12,5	
POLYPROPYLENE						
	white		80850	80851	80852	80853
	cream white RAL 9001		80854	80855	80856	80857
	ivory RAL 1015		80858	80859	80860	80861
	beige grey RAL 1019		80862	80863	80864	80865
ZQP/ /EI	stone grey RAL 7030		80866	80867	80868	80869
	light grey RAL 7035		80870	80871	80872	80873
	anthracite		80874	80875	80876	80877
	beige bahama		80882	80883	80884	80885
	brown		80886	80887	80888	80889

euro/pc

no partial packaging - pack of 50 pcs Euro

to order the pack of 50 pcs, mark /50 after the article code (for example, code 80850 becomes 80850/50)

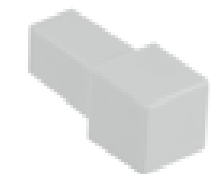

ZQP/ EI
white polypropylene

Complete the article code with H measure
(for example ZQP/ for H=8 becomes ZQP/8)

Colours available on demand - minimum quantity
2700 meters

cerfix® proangle

Proangle in aluminium is a line of profiles for edging and protecting the external corners of ceramic coverings. Its L shape outlines clearly tile coverings, such as rectified porcelain stoneware.

Available in different colours and finishes, Proangle can also be used as decorative element, creating refined and pleasant combination/contrast effects with a wide variety of coverings.

ZQVNH/ boasts the certified antibacterial technology (in compliance with ISO 22196:2011 standards) which reduces the presence of the most dangerous bacteria up to 99%, thus assuring the best hygiene over time.



ZA/10 silver anodised aluminium

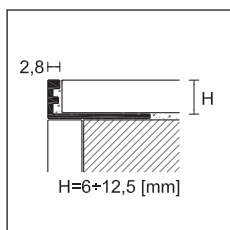
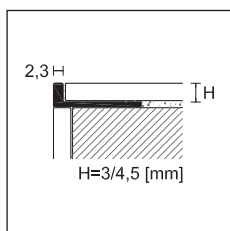

PROANGLE

length = 270 cm - pack 20 pcs

		H								
ART.	finishing	3	4,5	6	8	9	10	11	12,5	
ALUMINIUM										
	silver anodised		90338	90340	88204	88205	88217	88206	88218	88207
	<i>euro/m</i>									
ZA/	titanium anodised		-	-	88253	88254	-	88255	88257	88256
	<i>euro/m</i>									
	black anodised		-	-	-	88265	-	88266	88267	88268
	<i>euro/m</i>									
ZB/	bright polished silver		-	88260	88294	88295	-	88296	88220	88297
	<i>euro/m</i>									
	bright polished gold		-	88261	88339	88340	-	88341	-	88342
ZB/	bright polished titanium		-	88333	88334	88335	-	88336	88337	88338
	<i>euro/m</i>									
ZBS/	bright brushed silver		-	-	-	-	-	88356	88357	88358
ZTM/	bright brushed titanium		-	-	-	-	-	88359	88360	88361
	<i>euro/m</i>									
ZBS/	bright brushed black		-	-	-	-	-	88353	88354	88355
	<i>euro/m</i>									
COLOUR-COATED ALUMINIUM										
ZV/	colour-coated matt white RAL 9003		-	-	-	88395	-	88396	88435	88397
	colour-coated white RAL 9003		-	-	88384	88385	-	88386	88436	88387
	<i>euro/m</i>									
ANTIBACTERIAL COLOUR-COATED ALUMINIUM										
ZVH/	colour-coated white RAL 9003		-	-	-	88390	-	88392	-	88394
	<i>euro/m</i>									

individually packed

Complete the article code with H measure (for example ZA/ for H=8 becomes ZA/8)

Items ZV/ available in different colours on demand - minimum quantity 540 meters for colour.

Proangle: for different heights till 25 mm please see page 94-95

Items ZA-AI bendable version see page 96



ZA/10 black anodised aluminium



ZA/10 titanium anodised aluminium

Colour-coated aluminium Trend Color Stone: modern finishes with neutral but warm and soft shades which reproduce the heterogeneity of stone thanks to a rough texture.

Colour-coated aluminium Trend Color Concrete: six original cement-effect finishes that recall the typical metropolis colours by revisiting them from a more refined point of view.

Colour-coated aluminium Trend Color Metal: two special metal tonalities which reproduce the iridescent nature of metals.



ZV/10 beige colour-coated aluminium

PROANGLE - TREND COLOR

length = 270 cm - pack 20 pcs

H

ART.	finishing	8	10	11	12,5
------	-----------	---	----	----	------

COLOUR-COATED ALUMINIUM

TREND COLOR STONE

dark brown		88446	88407	88417	88481
anthracite grey		88447	88398	88408	88482
ancient grey		88448	88400	88410	88483
grey		88449	88405	88415	88484
rust		88450	88399	88409	88485
bronze		88451	88406	88416	88486
stone		88452	88404	88414	88491
greige		88453	88403	88413	88492
sand		88454	88402	88412	88493
beige		88455	88401	88411	88494
white stone		88456	88428	88433	88495
ZV/ black stone		88457	88429	88434	88496

TREND COLOR CONCRETE

concrete white		88469	88437	88461	88497
concrete graphite		88470	88438	88462	88498
concrete smoke		88471	88439	88463	88499
concrete mud		88472	88440	88464	88500
concrete sand		88473	88441	88465	88501
solid white		88478	88460	88468	88502

TREND COLOR METAL

metal dark		88479	88458	88466	88503
metal light		88480	88459	88467	88504

euro/m

individually packed

TREND
COLOR

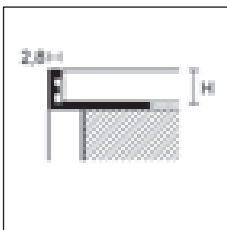

ZV/



ZV/10 white stone colour-coated aluminium

LED-light profiles and skirting boards with Trend Color finishes on page 228 and 232.

Complete the article code with H measure (for example ZV/ for H=10 becomes ZV/10).

Proangle in stainless steel is a line of profiles for edging and protecting the external corners of ceramic coverings. Its L shape outlines clearly tile coverings, such as rectified porcelain stoneware.

Stainless steel makes the profile particularly resistant to chemical and atmospheric agents. The AISI 316 DIN 1.4404 quality offers superior resistance to corrosion and is therefore recommended for applications in areas subject to greater chemical stress, such as swimming pools and food industries, and coastal areas.

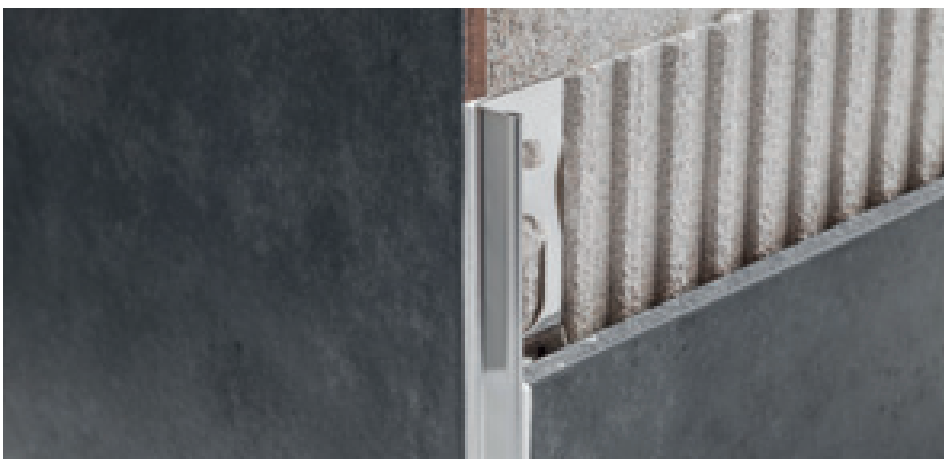

AI/10 stainless steel AISI 304 - DIN 1.4301

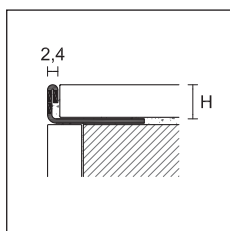

PROANGLE

length = 270 cm - pack 20 pcs

		H								
ART.	finishing	3	4,5	6	8	9	10	11	12,5	
STAINLESS STEEL										
AI/	stainless steel AISI 304 - DIN 1.4301 <i>euro/m</i>	91636	91638	91642	91644	91645	91646	91647	91648	
AIL/	superpolished stainless steel AISI 304 - DIN 1.4301 <i>euro/m</i>	-	91690	-	91694	-	91696	-	91698	
AIS/	brushed stainless steel AISI 304 - DIN 1.4301 <i>euro/m</i>	-	91671	91673	91674	-	91675	91677	91676	
AIP/	sandblasted stainless steel AISI 304 - DIN 1.4301 <i>euro/m</i>	-	-	91700	91702	-	91704	91705	91706	
AIX/	stainless steel AISI 316 - DIN 1.4404 <i>euro/m</i>	-	-	91684	91685	-	91686	91688	91687	

individually packed

PROANGLE - OUTSIDE CORNER

pack 5 pcs

		H								
ART.	finishing	3	4,5	6	8	9	10	11	12,5	
STAINLESS STEEL										
AI//E	stainless steel AISI 304 - DIN 1.4301 <i>euro/pc</i>	-	-	-	-	-	91663	91664	91665	
AIS//E	brushed stainless steel AISI 304 - DIN 1.4301 <i>euro/pc</i>	-	-	-	-	-	91680	91681	91682	

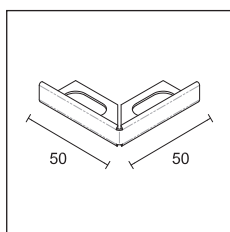

AI//E
AIS//E



AI//E stainless steel AISI 304 - DIN 1.4301

Complete the article code with H measure
(for example AI/ for H=10 becomes AI/10)

cerfix® proangle-prodecor

Proangle ZK and Prodecor DJK are two L-shaped profiles in chromium-plated brass, with different section, designed for edging and protecting the external corners of ceramic coverings. Chromium-plated brass stands out for its brilliance and is perfect as decorative element in spaces characterized by elegance and attention to details.



Proangle ZK/ chromium-plated brass

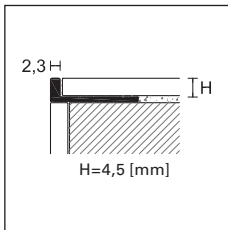

ZK/



PPDESIGN

PROANGLE

length = 270 cm - pack 20 pcs

ART.	finishing	4,5	6	8	9	10	11	12,5
------	-----------	-----	---	---	---	----	----	------

CHROMIUM-PLATED BRASS

ZK/	chromium plated		90081	88114	88115	-	88116	88118	88117
	euro/m								

individually packed

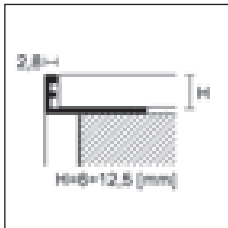

ZK/

PPDESIGN

PRODECOR DJ

length = 270 cm - pack 20 pcs

ART.	finishing	8	10	12,5	15	20
------	-----------	---	----	------	----	----

CHROMIUM-PLATED BRASS

DJK/	chromium plated		95700	95702	95704	95703	95705
	euro/m						

individually packed - art. DJK/20 pack 10 pcs

PRODECOR DJ - OUTSIDE AND INSIDE CORNERS

pack 5 pcs

ART.	finishing	8	10	12,5	15	20
------	-----------	---	----	------	----	----

CHROMIUM-PLATED BRASS

DJK/ /EI	chromium plated		95706	95707	95708	95709	95710
	euro/pc						

no partial packaging

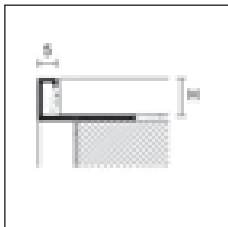

DJK/



DJK/ /EI

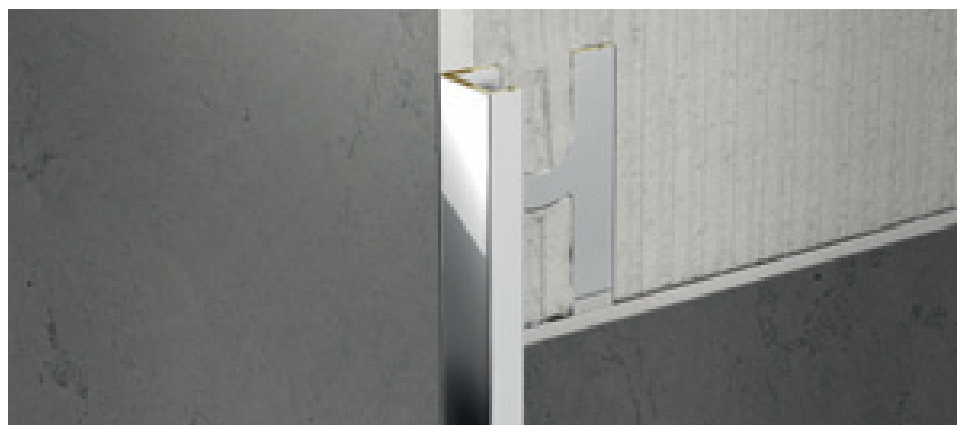

Prodecor DJK/ chromium-plated brass

Complete the article code with H measure (for example ZK/ for H=8 becomes ZK/8)

external corners profiles

cerfix® proangle

Proangle in PVC is a line of profiles for edging and protecting the external corners of ceramic coverings. Its L shape outlines clearly tile coverings, such as rectified porcelain stoneware. Available in many different colours, they can be used in the most varied spaces.



PV/8 beige grey PVC

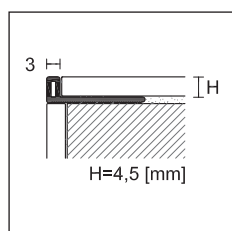













PV/



PROANGLE

length = 270 cm

		H					
ART.	finishing	4,5	6	8	10	12,5	
PVC							
	snow white		80610	80496	80497	80498	80499
	white		80611	80500	80501	80502	80503
	cream white RAL 9001		-	80504	80505	80506	80507
	ivory RAL 1015		-	80508	80509	80510	-
	beige grey RAL 1019		-	80512	80513	80514	-
	beige bahama		-	80552	80553	80554	-
	stone grey RAL 7030		-	80516	80517	80518	-
	ash grey RAL 7038		-	80520	80521	80522	-
	light grey RAL 7035		-	80524	80525	80526	80527
	anthracite		-	80559	80560	80561	-
	red RAL 3002		-	80528	80529	80530	-
	black RAL 9005		-	80532	80533	80534	-

pack 20 pcs

euro/m

pack 100 pcs

euro/m

no partial packaging

to order the pack of 100 pcs, mark /100 after article code (for example code 80497 becomes 80497/100)

Complete the article code with H measure (for example PV/ for H=8 becomes PV/8)

Items PV/ available in different colours on demand - minimum quantity 2700 meters for colour

Protrim IP are minimalist profiles in aluminium or stainless steel, suitable for the edging of external corners that need the 45 degrees cut. These profiles allow a perfect installation both on wall coverings and on stairs or platforms in ceramic or wood.



IPA/11 silver anodised aluminium



IPI/11 stainless steel AISI 304 - DIN 1.4301

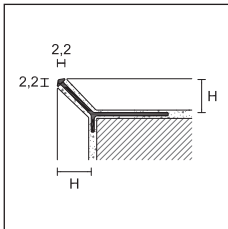

IPA/
IPB/
IPV/



TREND
COLOR



IPV/11 beige colour-coated aluminium

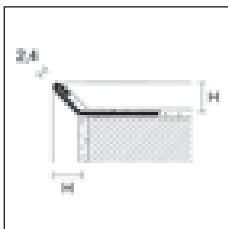

IPV/

PROTRIM IP

length = 270 cm - pack 20 pcs

ART.	finishing		4,5	8	11	15
ALUMINIUM						
IPA/	silver anodised		95006	95178	95181	95185
	<i>euro/m</i>					
IPB/	bright polished silver		95008	-	-	-
	<i>euro/m</i>					

individually packed

PROTRIM IP - TREND COLOR STONE

length = 270 cm - pack 20 pcs

ART.	finishing	11
COLOUR-COATED ALUMINIUM		

TREND COLOR STONE

dark brown		95182
anthracite grey		95183
ancient grey		95184
grey		95186
rust		95187
bronze		95188
stone		95189
greige		95190
sand		95191
beige		95192
IPV/ white stone		95193
black stone		95194

NEW TREND COLOR CONCRETE

concrete white		95195
concrete graphite		95196
concrete smoke		95197
concrete mud		95198
concrete sand		95199
solid white		95205

NEW TREND COLOR METAL

metal dark		95206
metal light		95217

euro/m

individually packed - Other heights with TREND COLOR finishes are available upon request, with a minimum of 540 meters.

PROTRIM IP

length = 270 cm - pack 20 pcs

ART.	finishing		7	8	11	12,5
STAINLESS STEEL						
IPI/	stainless steel AISI 304 - DIN 1.4301		95169	95170	95173	95174
	<i>euro/m</i>					

individually packed

Complete the article code with H measure (es: IPA/ for H=10 becomes IPA/10)

Protrim in aluminium is a line of profiles with rounded shape, specially designed to edge and protect the external corners of ceramic coverings. Their shape also acts as symmetric finishing and helps preventing accidents.

RVH/ boasts the certified antibacterial technology (in compliance with ISO 22196:2011 standards) which reduces the presence of the most dangerous bacteria up to 99%, thus assuring the best hygiene over time.



RA/10 silver anodised aluminium

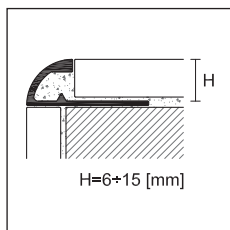
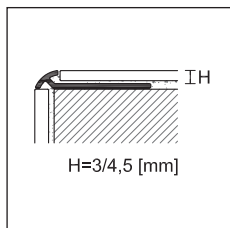

PROTRIM

length = 270 cm - pack 20 pcs

		H								
ART.	finishing	3	4,5	6	8	10	11	12,5	15	
ALUMINIUM										
RA/	silver anodised <i>euro/m</i>		92055	92056	92070	92072	92074	92060	92076	92078
	gold anodised <i>euro/m</i>		92025	92026	92040	92042	92044	-	92046	-
	titanium anodised <i>euro/m</i>		92085	92086	92087	92090	92094	-	92096	-
RB/	bright polished silver <i>euro/m</i>		92315	92316	92310	92312	92314	92061	92318	-
	bright polished gold <i>euro/m</i>		92325	92326	92340	92342	92344	-	92348	-
RB/	bright polished titanium <i>euro/m</i>		-	-	-	92029	92031	-	92032	-
	bright brushed silver <i>euro/m</i>		92050	92051	92071	92073	92075	92062	92077	-
RAS/	bright brushed gold <i>euro/m</i>		-	-	92041	92043	92045	-	92047	-
RTM/	bright brushed titanium <i>euro/m</i>		92053	92057	92064	92066	92068	-	92079	-
COLOUR-COATED ALUMINIUM										
RV/	matt white RAL 9003 <i>euro/m</i>		-	-	-	92107	92108	92109	92110	-
	white RAL 9003 <i>euro/m</i>		-	-	92100	92102	92104	92111	92106	-
ANTIBACTERIAL COLOUR-COATED ALUMINIUM										
RVH/	white RAL 9003 <i>euro/m</i>		-	-	-	92112	92114	-	92116	-

individually packed











Complete the article code with H measure (for example RA/ for H=8 becomes RA/8)

Items RV/ available in different colours on demand - minimum quantity 540 meters for colour













RAS/10 bright brushed silver aluminium

TA/ silver
anodised
aluminium**PROTRIM - OUTSIDE CORNER**

pack 5 pcs		H					
ART.	finishing	6	8	10	11	12,5	
ALUMINIUM							
TA/	silver anodised		92606	92608	92610	92600	92612
	gold anodised		92614	92616	92618	-	92619
	titanium anodised		92564	92566	92568	-	92569
<i>euro/pc</i>							
TB/	bright polished silver		92690	92692	92694	92601	92696
	bright polished gold		92700	92702	92704	-	92706
	bright polished titanium		-	92727	92731	-	92733
<i>euro/pc</i>							
TAS/	bright brushed silver		92710	92711	92712	92602	92713
	bright brushed gold		92720	92721	92722	-	92723
TATM/	bright brushed titanium		92714	92716	92718	-	92773
<i>euro/pc</i>							
COLOUR-COATED ALUMINIUM							
TV/	matt white RAL 9003		-	92636	92637	92638	92639
	white RAL 9003		92620	92622	92624	92628	92626
<i>euro/pc</i>							

no partial packaging

PROTRIM - INSIDE CORNER

pack 5 pcs		H					
ART.	finishing	6	8	10	11	12,5	
ALUMINIUM							
TIA/	silver anodised		92570	92571	92572	92603	92573
	gold anodised		92575	92576	92577	-	92578
	titanium anodised		92554	92555	92556	-	92558
<i>euro/pc</i>							
TIB/	bright polished silver		92580	92581	92582	92604	92583
	bright polished gold		92585	92586	92587	-	92588
	bright polished titanium		-	92746	92747	-	92748
<i>euro/pc</i>							
TIAS/	bright brushed silver		92550	92551	92552	92605	92553
	bright brushed gold		92560	92561	92562	-	92563
<i>euro/pc</i>							
COLOUR-COATED ALUMINIUM							
TIV/	matt white RAL 9003		-	92646	92647	92648	92649
	white RAL 9003		92621	92623	92625	92629	92627
<i>euro/pc</i>							

no partial packaging

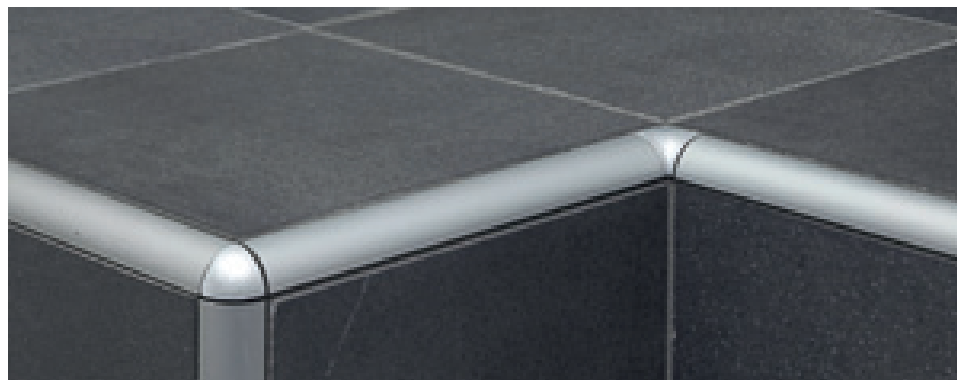
TIA/ silver
anodised
aluminiumComplete the article code with H measure
(for example TA/ for H=8 becomes TA/8)

RA/10+TA/10+TIA/10 silver anodised aluminium

cerfix® protrim

Protrim in stainless steel is a line of profiles with rounded shape, specially designed to edge and protect the external corners of ceramic coverings and also recommended for floors, steps, worktops and platforms.

The AISI 304 versions are recommended for food industries, kitchens, hospitals and outdoor spaces, while the AISI 316 versions are suggested in case of difficult applications, such as swimming pools, spas and places exposed to salt.



RI/10 stainless steel AISI 304 DIN 1.4301

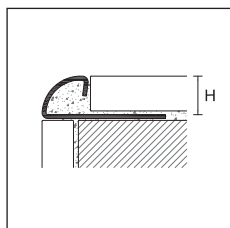

PROTRIM

length = 270 cm - pack 20 pcs

		H								
ART.	finishing	4,5	6	8	9	10	11	12,5	15	
STAINLESS STEEL										
RI/	stainless steel AISI 304 DIN 1.4301		92413	92420	92422	92423	92424	92425	92426	92428
	<i>euro/m</i>									
RIS/	brushed stainless steel AISI 304 - DIN 1.4301		-	92430	92431	92438	92432	92439	92433	92434
	<i>euro/m</i>		-							
RIP/	sandblasted stainless steel AISI 304 - DIN 1.4301		-	92450	92451	92452	92453	92454	92455	-
	<i>euro/m</i>		-							-
RIX/	stainless steel AISI 316 - DIN 1.4404		92405	92406	92407	92410	92408	92411	92409	-
	<i>euro/m</i>									-

individually packed - art. RI/15 pack 10 pcs

PROTRIM - OUTSIDE CORNER - pack 5 pcs

TIE/	stainless steel AISI 304 - DIN 1.4301		92750	92480	92481	92751	92482	92752	92483	92484
	<i>euro/pc</i>									
TIES/	brushed stainless steel AISI 304 - DIN 1.4301		-	92485	92486	92753	92487	92754	92488	92489
	<i>euro/pc</i>		-							
TIEP/	sandblasted stainless steel AISI 304 - DIN 1.4301		-	92510	92511	92512	92513	92514	92515	-
	<i>euro/pc</i>		-							-
TIEX/	stainless steel AISI 316 - DIN 1.4404		92500	92501	92502	92755	92503	92756	92504	-
	<i>euro/pc</i>									-

PROTRIM - INSIDE CORNER - pack 5 pcs

TII/	stainless steel AISI 304 - DIN 1.4301		92759	92490	92491	92757	92492	92758	92493	92494
	<i>euro/pc</i>									
TIIS/	brushed stainless steel AISI 304 - DIN 1.4301		-	92495	92496	92760	92497	92761	92498	92499
	<i>euro/pc</i>		-							
TIIP/	sandblasted stainless steel AISI 304 - DIN 1.4301		-	92516	92517	92518	92519	92520	92521	-
	<i>euro/pc</i>		-							-
TIIX/	stainless steel AISI 316 - DIN 1.4404		92505	92506	92507	92762	92508	92763	92509	-
	<i>euro/pc</i>									-

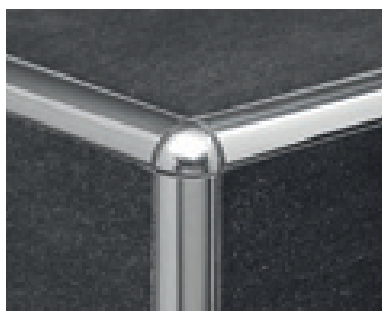

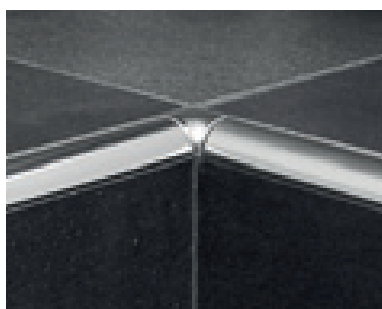

RI/10 + TIE/10 stainless steel AISI 304 DIN 1.4301



RI/10 + TII/10 stainless steel AISI 304 DIN 1.4301

Complete the article code with H measure
(for example RI/ for H=8 becomes RI/8)

METAL		8	10	11
OUTSIDE CORNER - pack 5 pcs				
TIME/	polished stainless steel		-	-
	<i>euro/pc</i>	92960	92964	92966
		-	-	-
INSIDE CORNER - pack 5 pcs				
TIMI/	polished stainless steel		-	-
	<i>euro/pc</i>	92970	92974	92976
		-	-	-

no partial packaging



RIN/10 stainless steel AISI 304 - DIN 1.4301

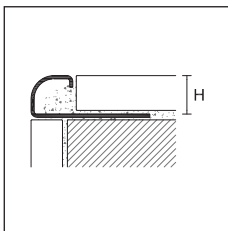



RIN/
RINS/
RINX/



PROTRIM N

length = 270 cm - pack 20 pcs

ART.	finishing		8	10	12,5
STAINLESS STEEL					
RIN/	stainless steel AISI 304 - DIN 1.4301		92353	92356	92359
	<i>euro/m</i>				
RINS/	brushed stainless steel AISI 304 - DIN 1.4301		92354	92357	92360
	<i>euro/m</i>				
RINX/	stainless steel AISI 316 - DIN 1.4404		92355	92358	92361
	<i>euro/m</i>				

individually packed





TIEN/ stainless
steel AISI 304 -
DIN 1.4301





TIIN/ stainless
steel AISI 304 -
DIN 1.4301

PROTRIM N - OUTSIDE CORNER - pack 5 pcs

TIEN/	stainless steel AISI 304 - DIN 1.4301		92813	92816	92819
	<i>euro/pc</i>				
TIENS/	brushed stainless steel AISI 304 - DIN 1.4301		92814	92817	92820
	<i>euro/pc</i>				
TIENX/	stainless steel AISI 316 - DIN 1.4404		92815	92818	92821
	<i>euro/pc</i>				

PROTRIM N - INSIDE CORNER - pack 5 pcs

TIIN/	stainless steel AISI 304 - DIN 1.4301		92828	92831	92834
	<i>euro/pc</i>				
TIINS/	brushed stainless steel AISI 304 - DIN 1.4301		92829	92832	92835
	<i>euro/pc</i>				
TIINX/	stainless steel AISI 316 - DIN 1.4404		92830	92833	92836
	<i>euro/pc</i>				

Complete the article code with H measure
(for example RIN/ for H=8 becomes RIN/8)

cerfix® protrim

Protrim in polished brass is classic and modern at the same time and can be easily combined to handles, taps and other furniture accessories of the same material and finish.

The chromium-plated version stands out for its brilliance and is perfect as decorative element in spaces characterized by elegance and attention to details.



RKN/10 chromium-plated brass

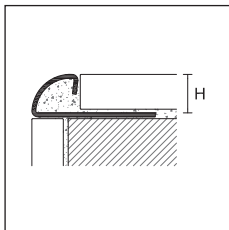



RLN/
RKN/



PPDESIGN

PROTRIM



length = 270 cm - pack 20 pcs

		H				
ART.	finishing	6	8	10	12,5	
POLISHED BRASS						
RLN/	polished		92465	92466	92467	92468
		<i>euro/m</i>				
CHROMIUM-PLATED BRASS						
RKN/	chromium plated		92469	92470	92471	92472
		<i>euro/m</i>				

individually packed - art. RLN/10, RLN/12,5, RKN/10, RKN/12,5 packaging of 10 pcs

PROTRIM - OUTSIDE / INSIDE CORNERS

pack 5 pcs



		H				
ART.	finishing	6	8	10	12,5	
OUTSIDE CORNERS FOR RLN/ ARTICLES						
ALUMINIUM						
TB/	bright polished gold		92700	92702	92704	92706
		<i>euro/pc</i>				
INSIDE CORNERS FOR RLN/ ARTICLES						
ALUMINIUM						
TIB/	bright polished gold		92585	92586	92587	92588
		<i>euro/pc</i>				

no partial packaging

pack 5 pcs

OUTSIDE CORNERS IN SUPERPOLISHED STAINLESS STEEL FOR RKN/ ITEMS

STAINLESS STEEL

TIEL/	superpolished stainless steel AISI 304 DIN 1.4301		92792	92794	92798	92802
		<i>euro/pc</i>				
INSIDE CORNERS IN SUPERPOLISHED STAINLESS STEEL FOR RKN/ ITEMS						
STAINLESS STEEL						
TIIL/	superpolished stainless steel AISI 304 DIN 1.4301		92793	92795	92799	92803
		<i>euro/pc</i>				



TIEL/



TIIL/

Complete the article code with H measure
(for example RLN/ for H=8 becomes RLN/8)

Protrim in coextruded PVC is a line of profiles with rounded shape, specially designed to edge and protect the external corners of ceramic coverings. Their shape also acts as symmetric finishing and helps preventing accidents. Thanks to the special section with soft PVC inserts, these profiles absorb the micro-movements that discharge on the corner due to the tension of the wall coverings. Mass-dye coloured, they are available in many different colours and can be used in the most varied spaces.



RPA/8 white co-extruded PVC

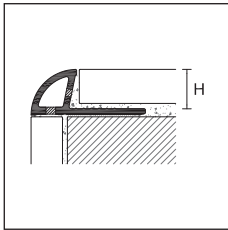

RPA/



PROTRIM

length = 270 cm - pack 20/100 pcs

		H		
		CO-EXTRUDED PVC		
ART.	finishing	6	8	10
	snow white	80640	80641	80642
	white	80644	80645	80646
	cream white RAL 9001	80648	80649	80650
	ivory RAL 1015	80652	80653	80654
RPA/	beige grey RAL 1019	80656	80657	80658
	stone grey RAL 7030	80660	80661	80662
	ash grey RAL 7038	80664	80665	80666
	light grey RAL 7035	80668	80669	80670
	beige bahama	80680	80681	80682
	brown	80692	80693	80694

pack 20 pcs
euro/m

pack 100 pcs
euro/m

no partial packaging

To order profiles in packs of 100 pcs, mark /100 after article code (for example code 80640 becomes 80640/100)

PROTRIM

pack 12 pcs

		H					
		TPAE/			TPAI/		
		POLYPROPYLENE					
		OUTSIDE CORNER			INSIDE CORNER		
finishing		6	8	10	6	8	10
snow white		80700	80701	80702	80753	80751	80752
white		80703	80704	80705	80750	80754	80755
cream white RAL 9001		80706	80707	80708	80756	80757	80758
ivory RAL 1015		80709	80710	80711	80759	80760	80761
beige grey RAL 1019		80712	80713	80714	80762	80763	80764
stone grey RAL 7030		80715	80716	80717	80765	80766	80767
ash grey RAL 7038		80718	80719	80720	80768	80769	80770
light grey RAL 7035		80721	80722	80723	80771	80772	80773
beige bahama		80730	80731	80732	80780	80781	80782
brown		80739	80740	80741	80789	80790	80791

euro/pc

To order corners in packs of 50 pcs, mark /50 after article code (for example code 80700 becomes 80700/50) - pack of 50 pcs Euro

Complete the article code with H measure (for example RPA/ for H=8 becomes RPA/8)

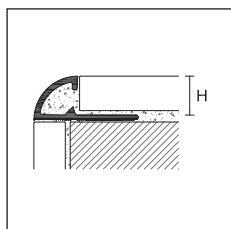

RE/

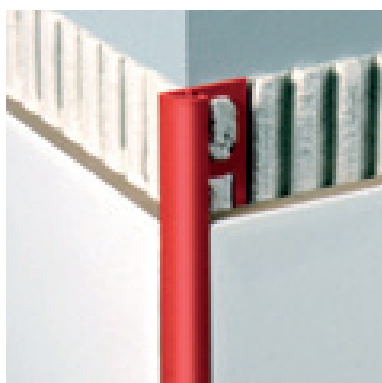

RE/8 PVC red RAL 3002

PROTRIM

lengt = 270 cm - pack 20/100 pcs

		H				
		PVC				
ART.	finishing	6	8	10	12,5	
	snow white	☐	79996	79997	79998	79999
	white	☐	80100	80101	80102	80103
	cream white RAL 9001	◻	80104	80105	80106	80107
	ivory RAL 1015	◻	80108	80109	80110	-
	beige grey RAL 1019	◻	80112	80113	80114	-
	stone grey RAL 7030	◻	80116	80117	80118	-
	ash grey RAL 7038	◻	80120	80121	80122	-
	light grey RAL 7035	◻	80124	80125	80126	80127
	anthracite	◻	80175	80176	80177	-
	blue	◻	80160	80161	80162	-
	pastel blue	◻	80140	80141	80142	-
RE/	light green	◻	80179	80180	80181	-
	red RAL 3002	◻	80128	80129	80130	-
	black RAL 9005	◻	80132	80133	80134	-
	yellow RAL 1023	◻	80136	80137	80138	-
	pastel pink	◻	80144	80145	80146	-
	beige bahama	◻	80150	80151	80152	-
	peach	◻	80154	80155	80156	-
	caramel	◻	80164	80165	80166	-
	brown	◻	80168	80169	80170	-
	dark brown	◻	80172	80173	80174	-
	coral red	◻	80187	80188	80189	-
	raw sienna	◻	80191	80192	80193	-
	terracotta	◻	80195	80362	80194	-

pack 20 pcs - euro/m

pack 100 pcs - euro/m

no partial packaging - to order the pack of 100 pcs, mark /100 after article code

Complete the article code with H measure (for example RE/ for H=8 becomes RE/8)

PROTRIM

pack 12 pcs

		H				H				
		TE/				TE/				
		POLYPROPYLENE								
		OUTSIDE CORNER				INSIDE CORNER				
ART.	finishing	6	8	10	12,5	6	8	10	12,5	
	snow white	☐	80396	80397	80398	80399	79800	79801	79802	79803
	white	☐	80400	80401	80402	80403	79804	79805	79806	79807
	cream white RAL 9001	◻	80404	80405	80406	80407	79808	79809	79810	79811
	ivory RAL 1015	◻	80408	80409	80410	-	79812	79813	79814	-
	beige grey RAL 1019	◻	80412	80413	80414	-	79816	79817	79818	-
	stone grey RAL 7030	◻	80416	80417	80418	-	79820	79821	79822	-
	ash grey RAL 7038	◻	80420	80421	80422	-	79824	79825	79826	-
	light grey RAL 7035	◻	80424	80425	80426	80427	79828	79829	79830	79831
	anthracite	◻	80479	80480	80481	-	79875	79876	79877	-
	blue	◻	80470	80471	80472	-	79848	79849	79850	-
	pastel blue	◻	80440	80441	80442	-	79844	79845	79846	-
	light green	◻	80475	80476	80477	-	79879	79880	79881	-
	red RAL 3002	◻	80428	80429	80430	-	79832	79833	79834	-
	black RAL 9005	◻	80432	80433	80434	-	79836	79837	79838	-
	yellow RAL 1023	◻	80436	80437	80438	-	79840	79841	79842	-
	pastel pink	◻	80444	80445	80446	-	79852	79853	79854	-
	beige bahama	◻	80448	80449	80450	-	79856	79857	79858	-
	peach	◻	80452	80453	80454	-	79860	79861	79862	-
	caramel	◻	80458	80459	80460	-	79864	79865	79866	-
	brown	◻	80462	80463	80464	-	79868	79869	79870	-
	dark brown	◻	80466	80467	80468	-	79872	79873	79874	-
	coral red	◻	80483	80484	80485	-	79887	79888	79889	-
	raw sienna	◻	80487	80488	80489	-	79891	79892	79893	-
	terracotta	◻	80491	80492	80493	-	79895	79896	79897	-

euro/pc

no partial packaging

To order corners in packs of 50 pcs, mark /50 after article code (for example code 80396 becomes 80396/50) pack of 50 pcs. €/pcs

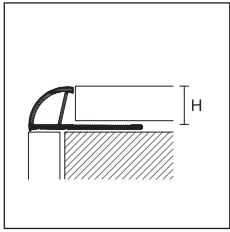

RECO/

PROTRIM ECO

length = 260 cm - pack 80 pcs

ART.	finishing	ECOLINE PVC			
		6	8	10	
	snow white		79400	79401	79402
	white		79403	79404	79405
	cream white RAL 9001		79406	79407	79408
RECO/ /80	ivory RAL 1015		79409	79410	79411
	ash grey RAL 7038		79412	79413	79414
	light grey RAL 7035		79415	79416	79417
	beige bahama		79418	79419	79420
	euro/m				

no partial packaging

others colour on request for minimum 2600 mt for colour

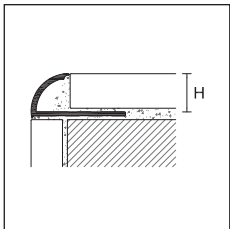

REC/

PROTRIM ECO

length = 260 cm - pack 100 pcs

ART.	finishing	ECOLINE PVC			
		-	8	10	
	snow white		-	79601/100	79602/100
	cream white RAL 9001		-	79605/100	79606/100
	ivory RAL 1015		-	-	79610/100
	beige grey RAL 1019		-	-	79614/100
REC/ /100	stone grey RAL 7030		-	-	79618/100
	ash grey RAL 7038		-	-	79622/100
	light grey RAL 7035		-	-	79626/100
	beige bahama		-	-	79642/100
	euro/m		-		

no partial packaging

others colour on request for minimum 2600 mt for colour



REC/10 white PVC ecoline

Complete the article code with H measure
(for example REC/ /100 for H=8 becomes
REC/8/100)

Proangle F is a triangular profile indicated as a decorative element and closing of the outside corners of the tiles.

The stainless steel version with reduced base is rather suitable for the protection and finishing of the interior angles of ceramic coverings.



FMB/10 + FMBE/10 bright polished silver aluminium

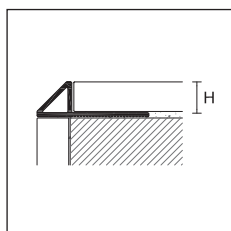

FMA/
FMB/



PROANGLE F

length = 270 cm - pack 20 pcs

ART. finishing		H			
		8	10	12,5	
ALUMINIUM					
FMA/	silver anodised <i>euro/m</i>		93025	93026	93027
FMB/	bright polished silver <i>euro/m</i>		93028	93029	93030

individually packed

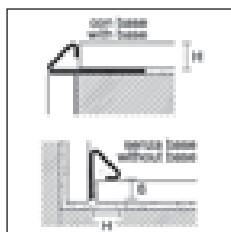

FMI/
FMIS/

PROANGLE F

length = 270 cm - pack 20 pcs

ART. finishing		H				
		8		10		
STAINLESS STEEL						
		with base	without base	with base	without base	
FMI/	stainless steel AISI 304 - DIN 1.4301 <i>euro/m</i>		93050	93051	93052	93053
FMIS/	brushed stainless steel AISI 304 - DIN 1.4301 <i>euro/m</i>		93054	93055	93056	93057

individually packed

OUTSIDE CORNER

pack 5 pcs		H			
ART. finishing		8	10	12,5	
ALUMINIUM					
FMAE/	silver anodised <i>euro/pc</i>		93031	93032	93033
FMBE/	bright polished silver <i>euro/pc</i>		93040	93041	93042

INSIDE CORNER

pack 5 pcs		H			
ART. finishing		8	10	12,5	
ALUMINIUM					
FMAI/	silver anodised <i>euro/pc</i>		93034	93035	93036
FMBI/	bright polished silver <i>euro/pc</i>		93043	93044	93045

END CAP

pack 5 pcs		H			
ART. finishing		8	10	12,5	
ALUMINIUM					
FMAC/	silver anodised <i>euro/pc</i>		93037	93038	93039
FMBC/	bright polished silver <i>euro/pc</i>		93046	93047	93048

OUTSIDE CORNER

pack 5 pcs		H		
ART. finishing		8	10	
STAINLESS STEEL				
FMIE/	stainless steel AISI 304 - DIN 1.4301 <i>euro/pc</i>		93058	93059
FMIES/	brushed stainless steel AISI 304 - DIN 1.4301 <i>euro/pc</i>		93064	93065

INSIDE CORNER

pack 5 pcs		H		
ART. finishing		8	10	
STAINLESS STEEL				
FMII/	stainless steel AISI 304 - DIN 1.4301 <i>euro/pc</i>		93060	93061
FMIS/	brushed stainless steel AISI 304 - DIN 1.4301 <i>euro/pc</i>		93066	93067

END CAP

pack 5 pcs		H		
ART. finishing		8	10	
STAINLESS STEEL				
FMIC/	stainless steel AISI 304 - DIN 1.4301 <i>euro/pc</i>		93062	93063
FMICS/	brushed stainless steel AISI 304 - DIN 1.4301 <i>euro/pc</i>		93068	93069

no partial packaging for aluminium accessories

Complete the article code with H measure (for example FMA/ for H=8 becomes FMA/8)

cerfix® proangle AX - pronivel M

Proangle AX M Design is a profile in anodised or colour-coated aluminium, which finishes the vertical edge of the coverings, accentuating the discontinuity between the wall in an elegant way.



AX/2/ silver anodised aluminium

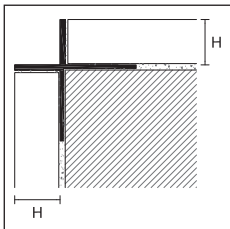

AX/2/



PROANGLE AX- M DESIGN

length = 270 cm - pack 10 pcs

		H			
ART.	finishing	6	10	12,5	
ALUMINIUM					
	silver anodised		13208	13209	13210
	<i>euro/m</i>				
AX/2/	titanium anodised		13211	13213	13212
	colour-coated polished white RAL 9010		13215	13216	13214
	<i>euro/m</i>				

individually packed

Pronivel M is a line of profiles designed to connect floors of different heights during the installation. Thanks to its shape, MIN/ can be also used as edging profile for the protection of 135-degree external corners of tile coverings.



MIN/10 polished stainless steel AISI 304 DIN 1.4301

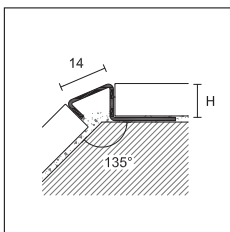

MIN/10



PRONIVEL M

length = 270 cm - pack 10 pcs

		H		
ART.	finishing	8	10	
MIN/	polished stainless steel AISI 304 - DIN 1.4301		93023	93024
	<i>euro/m</i>			

individually packed

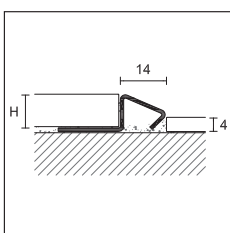

MIN/10 application for floors of different height

Complete the article code with H measure (for example MIN/ for H=10 becomes MIN/10)

cerfix® procorner M

Procorner M is a line of protection profiles of the outside corners of wall to be applied on the surfaces of the tiles already laid. Procorner profiles are also available in self-adhesive version for a quick and easy installation.

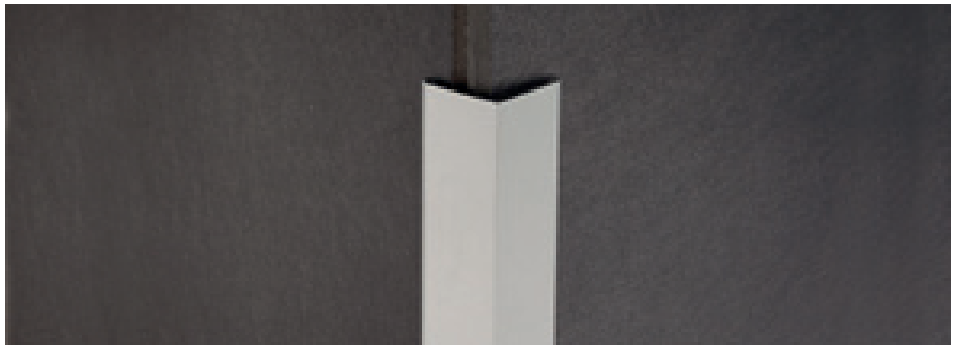

210/A silver anodised aluminium

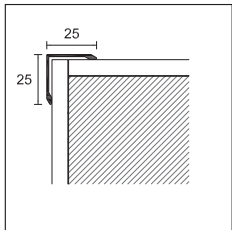

210/
210H/A



PROCORNER M

length = 300 cm - pack 30 pcs

LxL

25x25

ART.	finishing	/SF	/A
ALUMINIUM			
	silver anodised	76068	76098
	gold anodised	-	76108
210/	euro/m		
	colour-coated white RAL 9003	76128	76208

SF = not drilled A = adhesive
individually packed

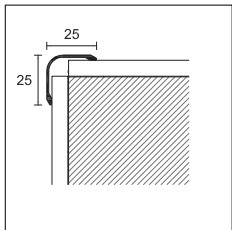

220/

PROCORNER M

length = 300 cm - pack 30 pcs

LxL

25x25

ART.	finishing	/SF	/A
ANTIBACTERIAL COLOUR-COATED ALUMINIUM			
210H/A	colour-coated antibacterial white RAL 9003	76209	
	euro/m		

A = adhesive
individually packed

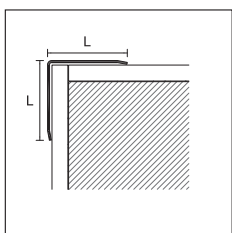

227/

PROCORNER M

length = 300 cm - pack 30 pcs

LxL

25x25

ART.	finishing	/SF	/A
ALUMINIUM			
	silver anodised	77888	77894
220/	euro/m		
	colour-coated white RAL 9003	77900	-
	euro/m		

SF = not drilled A = adhesive
individually packed

PROCORNER M

SILVER ANODISED ALUMINIUM

length = 300 cm - pack 30 pcs

ART.	measure LxL	code	euro/m
277/SF/	20x20	76308	
277/A/	adhesive 20x20	76309	
277/SF/	25x25	76318	
277/A/	adhesive 25x25	76319	
277/SF/	30x30	76328	
277/A/	adhesive 30x30	76329	

individually packed

Complete the article code with L measure (for example 277/SF/ for L= 20 becomes 277/SF/20)

Upon request, we can manufacture cerfix® procorner' with different dimensions. Please contact our technical department for further information.



775/A/40 polished stainless steel AISI 304 DIN 1.4301

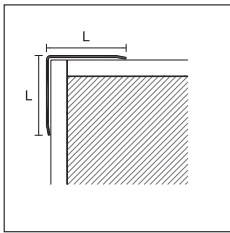

777/
776/

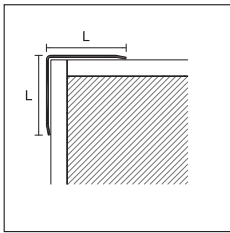

775/

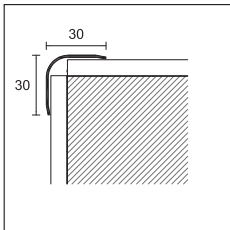

774/

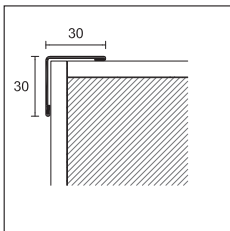

779/SF

PROCORNER M

POLISHED STAINLESS STEEL AISI 430 DIN 1.4016

length = 300 cm - thickness = 0,60 mm

ART.	measure LxL	code	euro/m	pack
777/SF/	15x15	76888		30
777/A/ adhesive	15x15	76938		30
777/SF/	20x20	76898		30
777/A/ adhesive	20x20	76948		30
777/SF/	25x25	76908		15
777/A/ adhesive	25x25	76958		15
777/SF/	30x30	76918		20
777/A/ adhesive	30x30	76968		20

length = 200 cm - thickness = 1 mm

ART.	measure LxL	code	euro/m	pack
776/SF/	30x30	77004		20
776/A/ adhesive	30x30	77044		20
776/SF/	40x40	77014		10
776/A/ adhesive	40x40	77054		10
776/SF/	50x50	77024		10
776/A/ adhesive	50x50	77064		10

length = 270 cm - thickness = 1 mm

ART.	measure LxL	code	euro/m	pack
776/SF/	30x30	77008		10
776/A/ adhesive	30x30	77048		10
776/SF/	40x40	77018		10
776/A/ adhesive	40x40	77058		10
776/SF/	50x50	77028		5
776/A/ adhesive	50x50	77068		5

POLISHED STAINLESS STEEL AISI 304 DIN 1.4301

length = 270 cm - thickness = 1 mm

ART.	measure LxL	code	euro/m	pack
775/SF/	30x30	77108		10
775/A/ adhesive	30x30	77148		10
775/SF/	40x40	77118		10
775/SF/	50x50	77128		5
775/A/ adhesive	50x50	77168		5

BRUSHED STAINLESS STEEL AISI 304 DIN 1.4301

length = 270 cm - thickness = 1 mm

ART.	measure LxL	code	euro/m	pack
775/SF/	30x30	77110		10
775/SF/	50x50	77130		5

POLISHED STAINLESS STEEL AISI 304 DIN 1.4301

length = 270 cm - thickness = 1 mm

ART.	measure LxL	code	euro/m	pack
774/SF	30x30	77954		10

BRUSHED STAINLESS STEEL AISI 304 DIN 1.4301

length = 270 cm - thickness = 1 mm

ART.	measure LxL	code	euro/m	pack
779/SF	30x30	77106		10

SF = not drilled A = adhesive

Complete the article code with L measure (for example 777/SF/ for L=15 becomes 777/SF/15)

Upon request, we can manufacture cerfix® procorner with different dimensions. Please contact our technical department for further information.

cerfix® procorner M - procorner P

Procorner M is a profile for the protection of the external corners of coverings. Recommended in places such as schools, offices, kindergartens and public spaces, it is available in polished brass to highlight the covering corners.

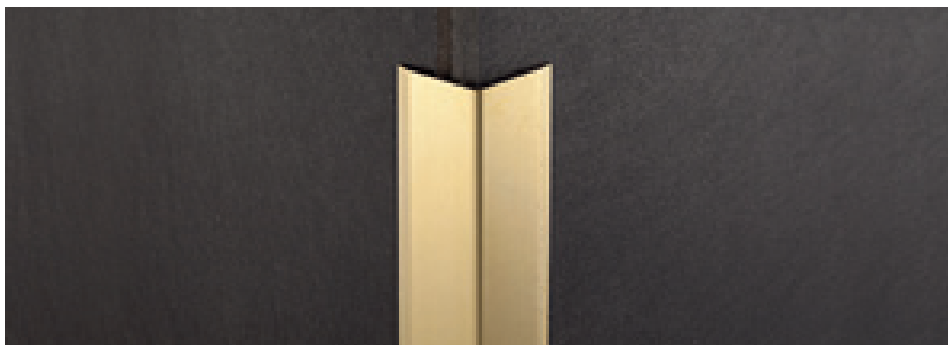

076/A/30 polished brass

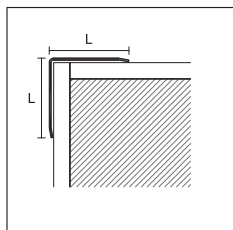

076/SF/
076/A/



PROCORNER M

POLISHED BRASS

length = 270 cm - thickness = 1,00 mm

ART.	measure LxL	code	euro/m	pack
076/SF/	15x15	76800		30
076/A/ adhesive	15x15	76840		15
076/SF/	20x20	76802		15
076/A/ adhesive	20x20	76842		15
076/SF/	25x25	76806		15
076/A/ adhesive	25x25	76846		10
076/SF/	30x30	76808		10
076/A/ adhesive	30x30	76848		10

SF = not drilled A = adhesive

Procorner P is an edge profile to protect from many issues. Recommended in environments such as schools, offices, kindergartens, public spaces, it is made of PVC soft and in bright colors to visually highlight the edges of the wall.

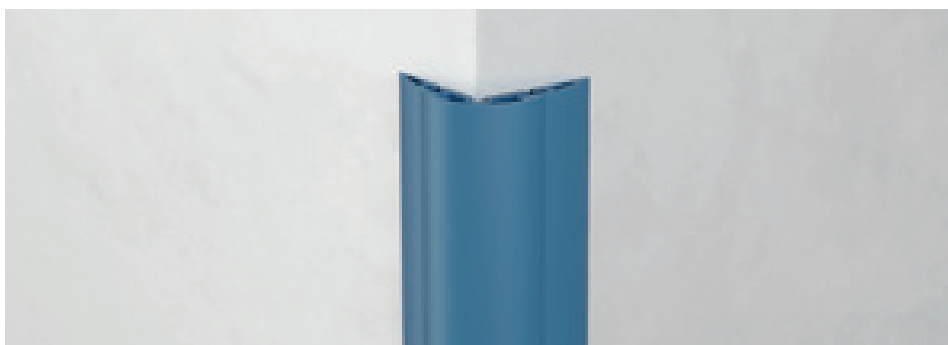

IP/40 blue soft PVC

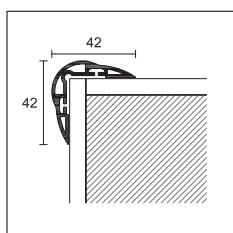

IP/40



PROCORNER P

length = 270 cm - pack 20 pcs

ART.	finishing	LxL
SOFT PVC		
IP/40	white	95010
	yellow	95011
	red	95012
	blue	95013
euro/m		

Complete the article code with L measure (for example 076/SF/ for L=15 becomes 076/SF/15)

Upon request, we can manufacture cerfix® procorner with different dimensions. Please contact our technical department for further information.

Article IP/40 in PVC should be stored horizontally

Procorner P 8610 and 8611 are a line of edging profiles in foam PVC that are impact resistant. Quick and easy to install, they are particularly suitable for DIY installations. Available in different vivid colours, they are suitable for places like schools, kindergartens and public spaces in general.



8610 white dec. 555

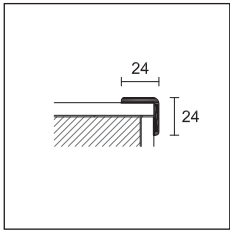

8610



PROCORNER P

length 300 cm - pack 20/50 pcs

FOAM PVC

ART.	decors		decors		decors	
	518	29810	536	29830	yellow 561	29848
	520	29812	540	29832	green 562	29850
	524	29814	542	29834	light blue 563	29847
	525	29816	544	29836	red 564	29849
8610	528	29818	545	29838		
	530	29820	white 555	29840		
	531	29822	light grey 556	29842		
	532	29824	black 557	29844		
	534	29828	anthracite 558	29846		

pack 20 pcs

euro/m

pack 50 pcs

euro/m

no partial packaging

PROCORNER P

length 300 cm - pack 20/50 pcs

FOAM PVC

ART.	decors		decors		decors		decors	
	518	29910	white 555	29940	yellow 561	29946	silver dec. 559	29949
8611	532	29924	light grey 556	29942	green 562	29948		
	542	29934	black 557	29944	light blue 563	29945		
	545	29938			red 564	29947		

pack 20 pcs

euro/m

pack 50 pcs

euro/m

no partial packaging

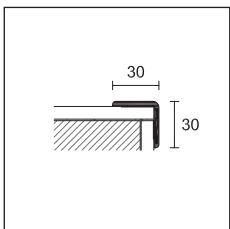

8611



8610 dec. 532

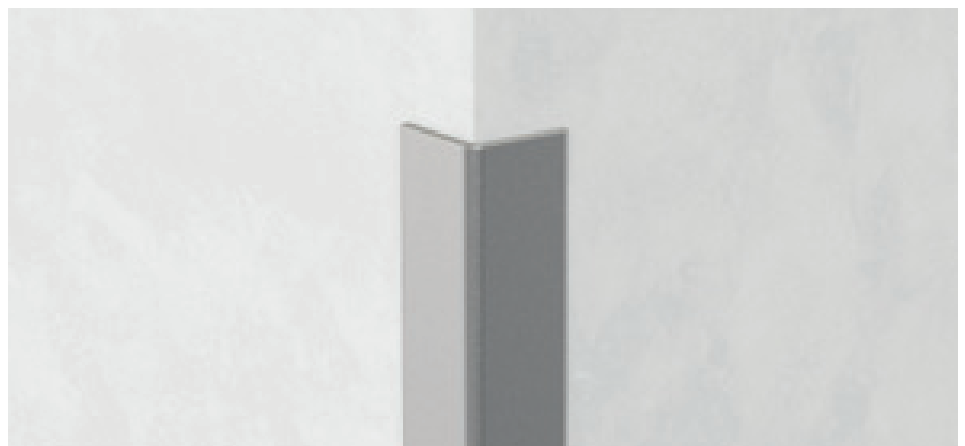

8611 silver dec. 559

Skirting board available with the same decors on page 217

external corners profiles

cerfix® probord

Stainless steel Probord ILN is a security profile for the outside corners of wall tiles. It can be combined with the profiles Proround M and it is recommended for the prevention of accidents and in environments where high hygienic safety is also required such as kitchens, food industries, schools etc.. The version in AISI 316 stainless steel is suitable for swimming pools, spa and in environments exposed to salt.



ILN/10 polished stainless steel AISI 304 DIN 1.4301

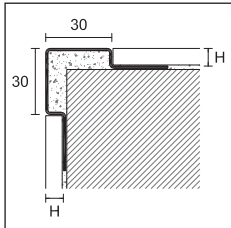

ILN/
ILNS/
ILNX/



PROBORD

length = 270 cm - pack 5 pcs

H

ART.	finishing	8	10	12,5
------	-----------	---	----	------

STAINLESS STEEL

ILN/	polished stainless steel AISI 304 - DIN 1.4301		94997	94998	94999
euro/m					
ILNS/	brushed stainless steel AISI 304 - DIN 1.4301		94984	94985	94986
euro/m					
ILNX/	stainless steel AISI 316 - DIN 1.4404		94987	94988	94989
euro/m					

individually packed

Probord IL, ILE and ILES have a rounded angle (compared to the model ILN). The fixing system with a single flange favors the correct alignment of the profile even in the presence of corners and uneven surfaces.



IL/10 polished stainless steel AISI 304 DIN 1.4301

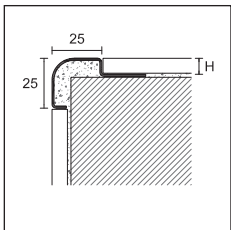

IL/



PROBORD

length = 270 cm - pack 10 pcs

H

ART.	finishing	8	10	12,5
------	-----------	---	----	------

STAINLESS STEEL

IL/	stainless steel AISI 304 - DIN 1.4301		94994	94995	94996
euro/m					

individually packed

PROBORD

length = 270 cm - pack 5 pcs

H

ART.	finishing	10
------	-----------	----

STAINLESS STEEL

ILE/10	polished stainless steel AISI 304 - DIN 1.4301		95002
euro/m			
ILES/10	brushed stainless steel AISI 304 - DIN 1.4301		95003
euro/m			

individually packed

Upon request, we can manufacture ILE/ and ILES/ with different dimensions or in stainless steel AISI 316 - DIN 1.4404.

Complete the article code with H measure (for example ILN/ for H=8 becomes ILN/8)

Upon request, we can manufacture cerfix profiles, probord ILN/ and IL/ with different dimensions.

Please contact our technical department for further information.

Cerfix Protop® is a profile for the protection and finishing of external corners of worktops and ceramic-coated kitchens. Also recommended for running boards and steps made with tiles.



TOP/A/10 silver anodised aluminium

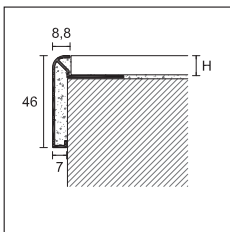

TOP/A/
TOP/TM/



PROTOP

length = 270 cm - pack 10 pcs

		H	
ART.	finishing	10	12
ALUMINIUM			
TOP/A/	silver anodised	86050	86060
	<i>euro/m</i>		
TOP/TM/	titanium anodised	86052	86062
	<i>euro/m</i>		
TOP/TM/	bright brushed titanium	86051	86061
	<i>euro/m</i>		

individually packed

OUTSIDE CORNER - pack 2 pcs

		90°		135°	
ART.	finishing	90°	135°	90°	135°
ALUMINIUM					
TOP/E	silver anodised	86074	86072	86074	86072
	titanium anodised	86080	86082	86080	86082
		<i>euro/pc</i>			
TOP/ETM	bright brushed titanium	86075	86073	86075	86073
	<i>euro/pc</i>				

INSIDE CORNER - pack 2 pcs

		90°		135°	
ART.	finishing	90°	135°	90°	135°
ALUMINIUM					
TOP/I	silver anodised	86078	86076	86078	86076
	titanium anodised	86081	86083	86081	86083
		<i>euro/pc</i>			
TOP/ITM	bright brushed titanium	86079	86077	86079	86077
	<i>euro/pc</i>				

no partial packaging



TOP/A/10 + TOP/90/E + TOP/135/I silver anodised aluminium

Complete the article code with H measure (for example TOP/A/ for H=10 becomes TOP/A/10)





listellos and decorative profiles

The line of decorative listellos provides a wide variety of finishes, suitable for endless combinations and multiple aesthetic architectural tastes, from classic to contemporary; they are applicable to all environments with ceramic tiles from kitchen to bathroom, from living rooms to large commercial spaces.

Prolist is a range of decorative listellos designed to create stylish and eye-catching aesthetic effects of wall tiles. They are available in different materials and colors, and can be coordinated to the profiles of the ranges PROTRIM and Proangle to obtain elegant and sophisticated combinations.

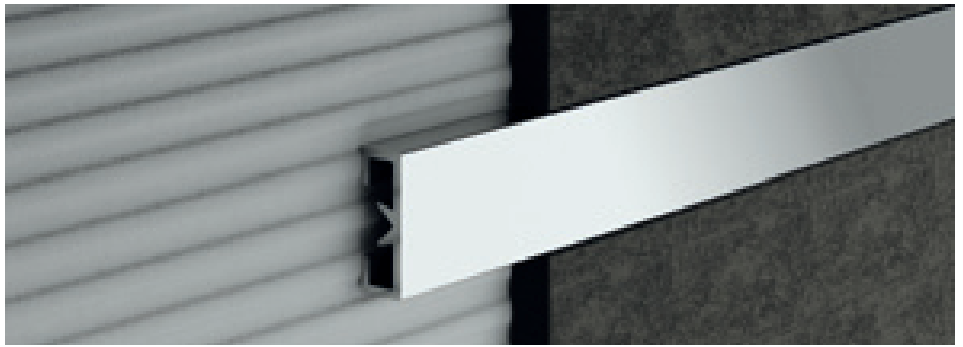

LDB/20 bright polished silver aluminium

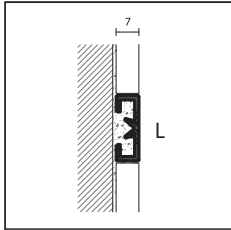

PROLIST

length = 270 cm - pack 20 pcs

		L x H				
ART.	finishing	10x7	15x7	20x7	25x7	
ALUMINIUM						
LDA/	silver anodised		93255	93215	93220	93256
		<i>euro/m</i>				
LDB/	bright polished silver		93258	93219	93224	93259
	bright polished titanium		93198	93199	93201	93203
		<i>euro/m</i>				
LDS/	bright brushed silver		93240	93216	93221	93244
	bright brushed gold		93241	93217	93222	93245
LDTM/	bright brushed titanium		93266	93211	93225	93246
LDRS/	bright brushed copper		93242	93267	93229	93269
		<i>euro/m</i>				
LDAG/	bright scratched silver		93263	93214	93228	93243
		<i>euro/m</i>				
COLOUR-COATED ALUMINIUM						
LDV/	white stone		-	-	93207	-
	black stone		-	-	93209	-
		<i>euro/m</i>				

individually packed

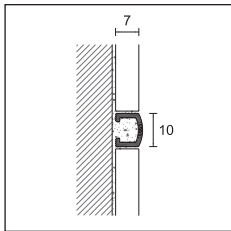

LB/B/10

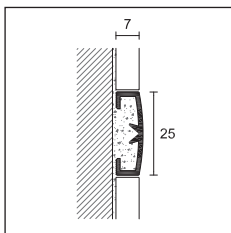

LB/A
LB/B/25

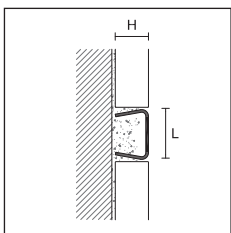

LA/I/
LA/IS/

PROLIST

length = 270 cm - pack 20 pcs

		L x H		
ART.	finishing	10x7	25x7	
ALUMINIUM				
LB/A	silver anodised		-	93270
		<i>euro/m</i>		
LB/B/	bright polished silver		93252	93272
	bright polished gold		93253	93273
		<i>euro/m</i>		

individually packed

PROLIST

length = 270 cm - pack 10 pcs

		L x H			
ART.	finishing	10x10	15x10	25x10	
STAINLESS STEEL					
LA/I/	polished stainless steel AISI 304 DIN 1.4301		93283	93284	93285
		<i>euro/m</i>			
LA/IS/	brushed stainless steel AISI 304 DIN 1.4301		93296	93297	93298
		<i>euro/m</i>			

individually packed

Complete the article code with L measure (for example LDA/ for L=10 becomes LDA/10)
Stainless steel listellos:
different measures on demand - minimum 108 meters

listellos and decorative profiles metal line AF - prolist x design

Metal Line AF M Design is a decorative listello in aluminium characterized by modern and minimalist lines that, thanks to its special shape, creates an elegant shadow that crosses the ceramic covering.



AF/1/10 silver anodised aluminium

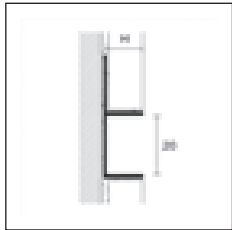

AF/1/



METAL LINE AF - M DESIGN

length = 270 cm - pack 10 pcs

ART.	finishing	6	10	12,5
ALUMINIUM				
	silver anodised		13198	13199
	<i>euro/m</i>			
AF/1/	titanium anodised		13201	13203
	colour-coated polished white RAL 9010		13196	13197
	<i>euro/m</i>			

individually packed

Prolist is available in five original finishes X Design. In anodised aluminium, X Design is characterized by a special scratched finish and original colours that allow different chromatic combinations, created for interior designers and architects by following the latest trends of modern design.

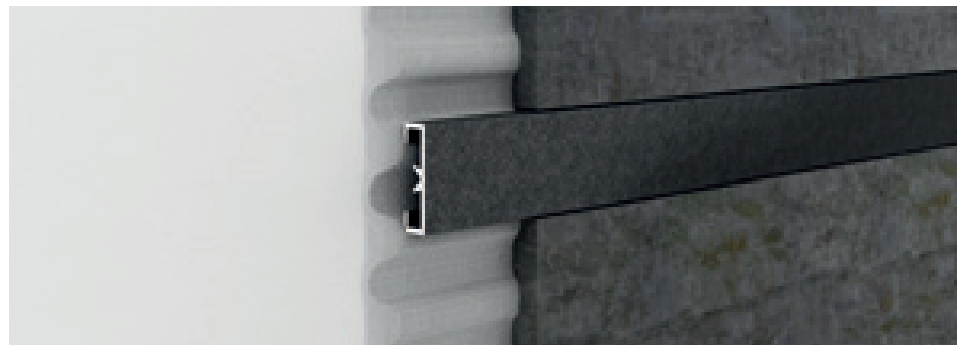

LDAD carbon anodised aluminium

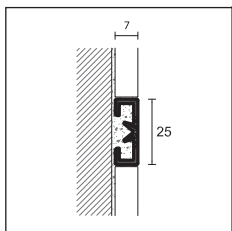

LDAD



PROLIST - X DESIGN

length = 270 cm - pack 10 pcs

ART.	finishing	L x H
		25x7
ANODISED ALUMINIUM		
	platinum	
	titanium	
LDAD	brown	
	dark brown	
	carbon	
	<i>euro/m</i>	

individually packed



LED-light decorative listellos on page 228



cerfix® C design

C Design is a line of profiles, embellished with crystals from Swarovski®. The combination of the chromium plated or gold plated profile and the crystal enhances the brightness of the lines and makes elegant any space.

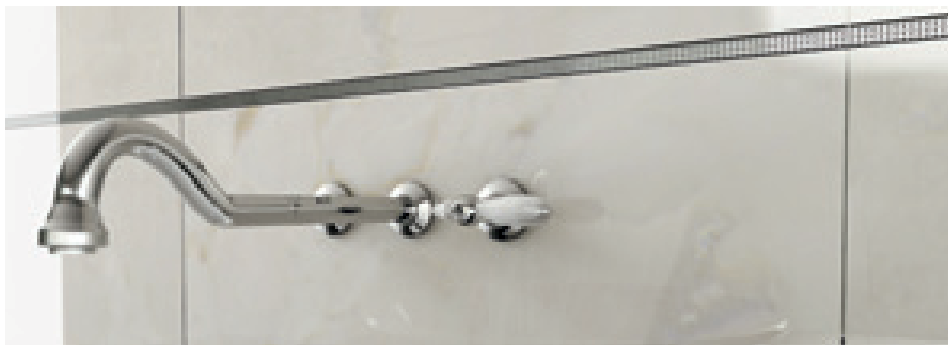

UKC/10 chromium-plated brass with crystals from Swarovski®



PRODECOR - C DESIGN

length = 270 cm - pack 5 pcs

H

ART. finishing

10

CHROMIUM-PLATED BRASS

chromium-plated + crystals from Swarovski®

13300

euro/m

DJKC/10

chromium-plated + crystals from Swarovski®

13302

euro/m

individually packed

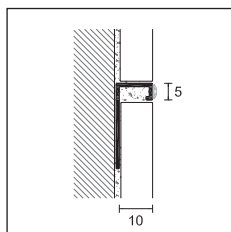

DJKC/10

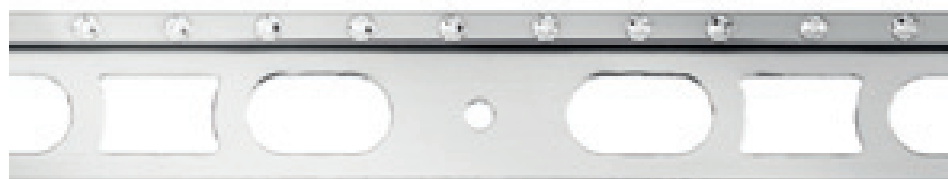

DJKC/10 chromium-plated brass with crystals from Swarovski® (cod. 13300)



DJKC/10 chromium-plated brass with crystals from Swarovski® (cod. 13302)

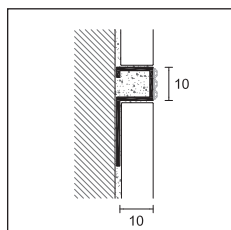

UKC/10

PROSTYLE - C DESIGN

length = 270 cm - pack 5 pcs

H

ART. finishing

10

CHROMIUM-PLATED BRASS

UKC/10 chromium-plated + crystals from Swarovski®

13310

euro/m

individually packed

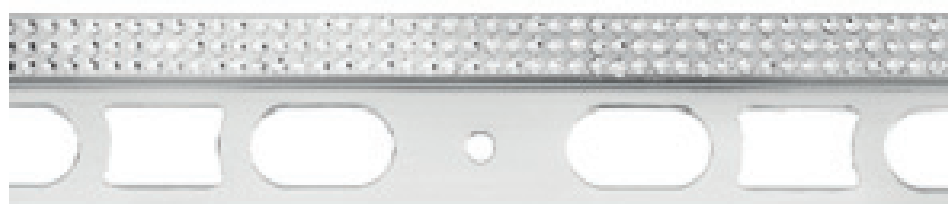

UKC/10 chromium-plated brass with crystals from Swarovski®

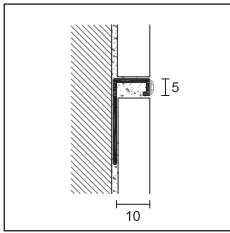

DJKGC/10



PRODECOR - C DESIGN

length = 270 cm - pack 5 pcs		H
ART.	finishing	10
BRASS		
DJKGC/10	24 kt gold plated + crystals from Swarovski®	13402
	euro/m	

individually packed



DJKGC/10 24 kt gold plated brass + crystals from Swarovski®

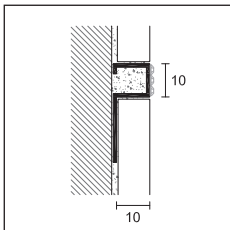

UKGC/10

PROSTYLE - C DESIGN

length = 270 cm - pack 5 pcs		H
ART.	finishing	10
BRASS		
UKGC/10	24 kt gold plated + crystals from Swarovski®	13410
	euro/m	

individually packed

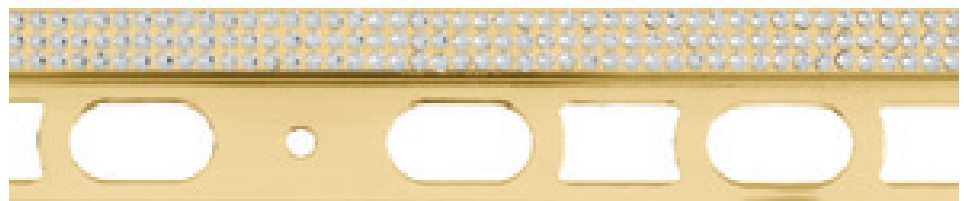

UKGC/10 24 kt gold plated brass + crystals from Swarovski®

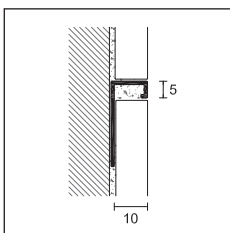

DJKG/10

PRODECOR - C DESIGN

length = 270 cm - pack 5 pcs		H
ART.	finishing	10
BRASS		
DJKG/10	24kt gold plated	12902
	euro/m	

individually packed

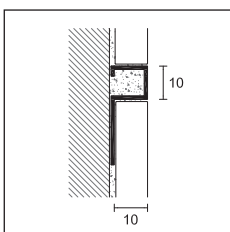

UKG/10

PROSTYLE - C DESIGN

length = 270 cm - pack 5 pcs		H
ART.	finishing	10
BRASS		
UKG/10	24kt gold plated	12910
	euro/m	

individually packed





internal corners profiles

A line of profiles that fits the perimetric junction between floor and wall. Created for the elimination of 90° corners and applicable to installed or to be installed floors, ensure high hygienic efficiency in private and public environments such as hospitals, food industries, SPA, swimming pools and industrial kitchens.

internal corners profiles

cerfix® proround

Proround M in aluminum is a connection profile between floor and wall. The current requirements for sanitary maintenance required by European standards, provide in fact the elimination of the 90° to avoid any deposit of dirty and possible sources of bacteria, creating a curvature to facilitate cleaning.



GA/10 silver anodised aluminium

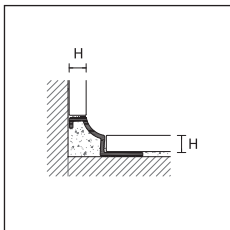

GA/4

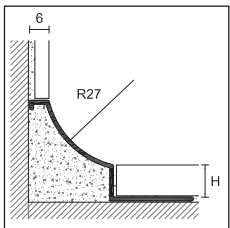

GA/8-10-12
GV/

PROROUND M

length = 270 cm - pack 10 pcs

		H			
ART.	finishing	4,5	8	10	12
ALUMINIUM					
GA/	silver anodised	95730	95031	95032	95033
	<i>euro/m</i>				
GV/	colour-coated white RAL 9003	-	95071	95072	95073
	<i>euro/m</i>	-			

individually packed- GA/4 packaging 20 pcs

OUTSIDE CORNER

pack 5 pcs

		H	
ART.	finishing	4,5	8 - 10 - 12
ALUMINIUM			
GTA/E	silver anodised	-	95075
	<i>euro/pc</i>	-	
GTV/E	colour-coated white RAL 9003	-	95083
	<i>euro/pc</i>	-	

INSIDE CORNER

pack 5 pcs

		H	
ART.	finishing	4,5	8 - 10 - 12
ALUMINIUM			
GTA/I	silver anodised	-	95077
	<i>euro/pc</i>		
GTV/I	colour-coated white RAL 9003	-	95085
	<i>euro/pc</i>	-	

no partial packaging

Complete the article code with H measure (for example GA/ for H=8 becomes GA/8)

Items GV available in different colours on demand - minimum quantity 540 meters per colour.



GTA/E silver anodised aluminium



GTA/I silver anodised aluminium



GA/4 silver anodised aluminium

Proround M GAN/ is a profile in aluminum for the connection between floor and wall, characterized by a 17-mm radius. GVNH/ boasts the certified antibacterial technology (in compliance with ISO 22196:2011 standards) which reduces the presence of the most dangerous bacteria up to 99%, thus assuring the best hygiene over time.



GAN/10 silver anodised aluminium

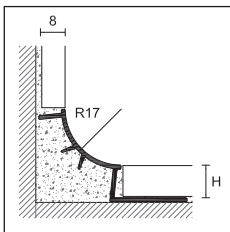

GAN/
GVNH/

PROROUND M

length = 270 cm - pack 10 pcs

		H		
ART.	finishing	8	10	12,5
ALUMINIUM				
GAN/	silver anodised	95034	95035	95036
<i>euro/m</i>				
GVNH/	colour-coated white RAL 9003 antibacterial	95037	95038	95039
<i>euro/m</i>				

individually packed

OUTSIDE/INSIDE/TRIAXIAL CORNER/END CAP

pack 12 pcs

		for all H			
ART.	finishing	GTP/E	GTP/I	GTP/T	GTP/C
POLYPROPYLENE					
	colour-coated silver	95121	95122	95123	95124
<i>euro/pc</i>					
	colour-coated white RAL 9003	95125	95126	95127	95128
<i>euro/pc</i>					

no partial packaging

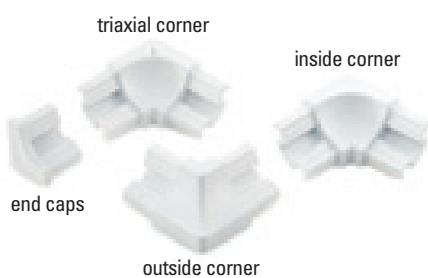

GTP/E silver colour-coated polypropylene

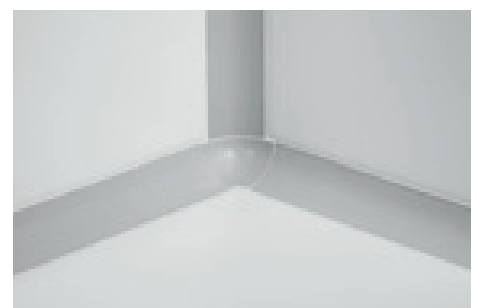

GTP/T silver colour-coated polypropylene

internal corners profiles

cerfix® proround

Stainless steel Proround M is a connection profile to be used in situations that require a particular level of sanitary protection (eg, medical, food industry, swimming pools, spas, industrial kitchens, hospitals, etc.). Specifically, the version in quality AISI 316 DIN 1.4404 offers characteristics of superior resistance to corrosion and is therefore recommended for use in areas subjected to higher chemical attacks, and sea zones.



GIN/10 + ILN/10 polished stainless steel AISI 304 DIN 1.4301

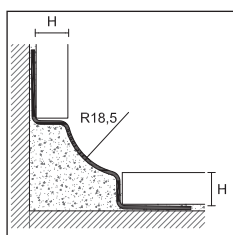

GIN 8/10/11

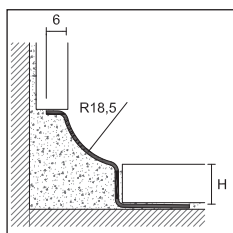

GIN /SA

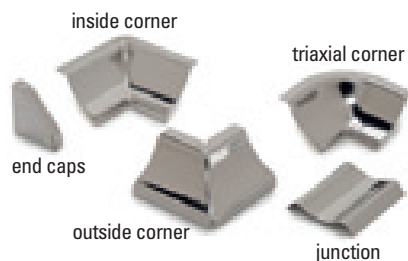

PROROUND M

length = 270 cm - pack 10 pcs

		H				
ART.	finishing	8	10	11	12,5	15
STAINLESS STEEL						
GIN/	polished stainless steel AISI 304 DIN 1.4301 <i>euro/m</i>	95046	95047	95045	-	-
GINS/	brushed stainless steel AISI 304 DIN 1.4301 <i>euro/m</i>	95050	95051	95057	-	-
GINX/	stainless steel AISI 316 DIN 1.4404 <i>euro/m</i>	95054	95055	-	-	-

individually packed

PROROUND M

length = 270 cm - pack 10 pcs

		H				
ART.	finishing	8	10	11	12,5	15
STAINLESS STEEL						
GIN/ /SA	polished stainless steel AISI 304 DIN 1.4301 <i>euro/m</i>	-	95044	-	95048	95049
GINS/ /SA	brushed stainless steel AISI 304 DIN 1.4301 <i>euro/m</i>	-	-	-	95052	-
GINX/ /SA	stainless steel AISI 316 DIN 1.4404 <i>euro/m</i>	-	-	-	95056	-

individually packed

		OUTSIDE CORNER-E		INSIDE CORNER-I		
pack 5 pcs		for all H		for all H		
ART.	finishing			ART.		
STAINLESS STEEL						
GTIN/E	polished stainless steel AISI 304 DIN 1.4301 <i>euro/pc</i>	95059		GTIN/I	95058	
GTINS/E	brushed stainless steel AISI 304 DIN 1.4301 <i>euro/pc</i>	95063		GTINS/I	95062	
GTINX/E	stainless steel AISI 316 DIN 1.4404 <i>euro/pc</i>	95067		GTINX/I	95066	

		TRIAXIAL CORNER-T		JUNCTION-G		END CAPS	
pack 5 pcs		for all H		for all H			
ART.	finishing			ART.	ART.		
GTIN/T	polished stainless steel AISI 304 DIN 1.4301 <i>euro/pc</i>	95060		GTIN/G	95061	GTIN/C	95040
GTINS/T	brushed stainless steel AISI 304 DIN 1.4301 <i>euro/pc</i>	95064		GTINS/G	95065	GTINS/C	95041
GTINX/T	stainless steel AISI 316 DIN 1.4404 <i>euro/pc</i>	95068		GTINX/G	95069	GTINX/C	95042

no partial packaging

Complete the article code with H measure (for example GIN/ for H=8 becomes GIN/8)

Cerfix® Proround M in stainless steel: other measures on demand - minimum quantity 540 meters

Proround P in non-toxic PVC and impact resistant is a connection profile between floor and wall. The current requirements for sanitary maintenance required by European standards, provide in fact the elimination of the 90 ° to avoid any deposit of dirty and possible sources of bacteria, creating a curvature to facilitate cleaning. Models with a single anchor flange allow to be used as a connection between the laying floors and walls with different thickness.

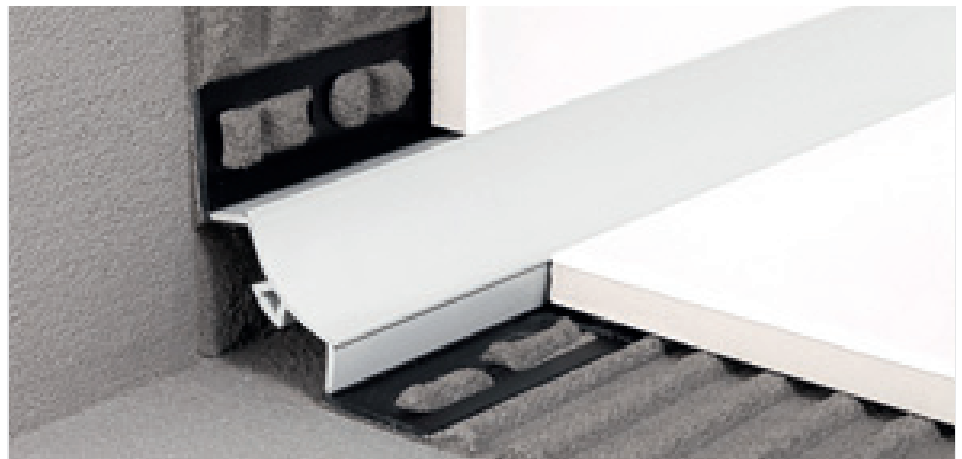

GP/10 white co-extruded PVC

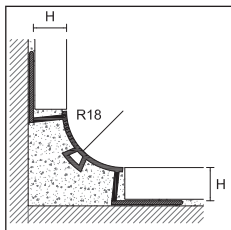



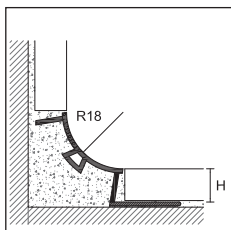

GP/



GPU/





PROROUND P

length = 270 cm - pack 20 pcs

ART.	H		H	
	GP/		GPU/	
finishing	8	10	10	12,5
CO-EXTRUDED PVC				
white		95800	95801	95804
light grey RAL 7035		95805	95806	-
stone grey RAL 7030		95810	95811	-
beige grey RAL 1019		95815	95816	-
euro/m				

INSIDE/OUTSIDE/TRIAXIAL CORNER/END CAP

pack 12 pcs

ART.	for all H			
	GTP/E	GTP/I	GTP/T	GTP/C
finishing				
POLYPROPYLENE				
white		95852	95851	95850
light grey RAL 7035		95862	95861	95860
stone grey RAL 7030		95872	95871	95870
beige grey RAL 1019		95882	95881	95880
euro/pc				

no partial packaging

Complete the article code with H measure (for example GP/ for H=8 becomes GP/8)



GTP/E RAL 7035 light grey polypropylene

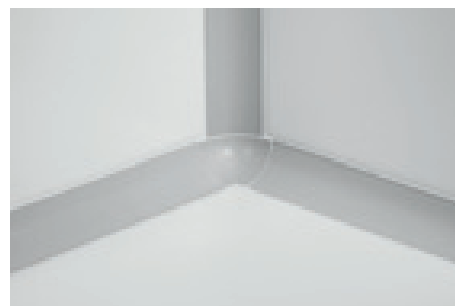

GTP/T RAL 7035 light grey polypropylene

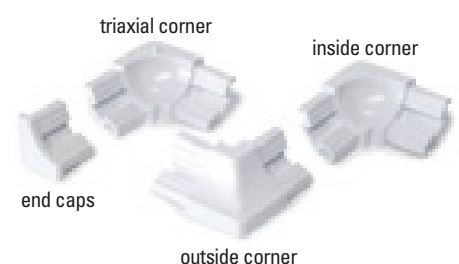

internal corners profiles

cerfix® proround

Proround M GIC/ and Proint PIN/ are two stainless steel profiles with rounded shape for the connection of floors and walls, to be used in those spaces where special hygiene protection is required.

The shape of GIC/ is particularly versatile thanks to the internal fixing flange.

The shape of PIN/ facilitates the corner connection of floors and walls, thus guaranteeing the expansion between the two surfaces.



GIC/8 polished stainless steel AISI 304 DIN 1.4301

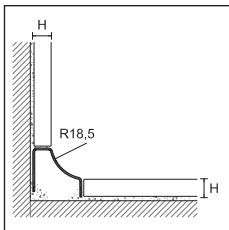

GIC/



PROROUND M

length = 270 cm - pack 5 pcs

ART. finishing

H

8

STAINLESS STEEL

GIC/ polished stainless steel
AISI 304 DIN 1.4301

95140

euro/m

OUTSIDE CORNER FOR GIC/

pack 5 pcs

ART. finishing

STAINLESS STEEL

GTIN/E polished stainless steel
AISI 304 DIN 1.4301

95059

euro/pc

no partial packaging

INSIDE CORNER FOR GIC/

pack 5 pcs

ART.

GTIN/I

95058

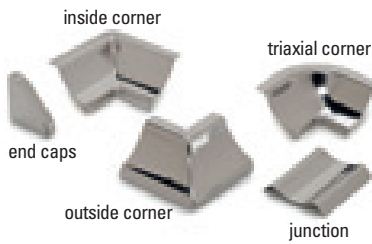

TRIAXIAL CORNER FOR GIC/

pack 5 pcs

ART. finishing

GTIN/T polished stainless steel
AISI 304 DIN 1.4301

95060

euro/pc

no partial packaging

JUNCTION FOR GIC/

pack 5 pcs

ART.

GTIN/G

95061

END CAPS FOR GIC/

ART.

GTIN/C

95040

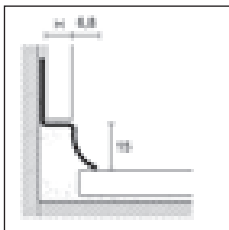

PIN/



PROINT

length = 270 cm - pack 10 pcs

ART. finishing

STAINLESS STEEL

PIN/ polished stainless steel
AISI 304 - DIN 1.4301

85392

euro/m

individually packed

H

10

12,5

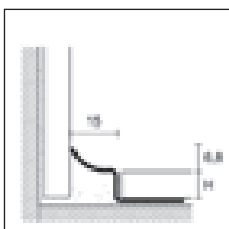

PIN/

Complete the article code with H measure (for example GIC/ for H=8 becomes GIC/8)

We can create profiles Cerfix Proround GIC/ with sizes on request, for floors and coverings of different thickness. Contact our technical department for more informations.



PIN/10 polished stainless steel AISI 304 DIN 1.4301

Proint PIA/ and PI/ are two line of profiles in aluminium and PVC, suitable as perimetral connection during the installation of the wall covering and the floor or as perimetral expansion joint.

The use of Proint PIA/ and PI/ allows to avoid the use of silicone for sealing and, in addition to the aesthetic advantage, it guarantees a high hygiene over time.

The special sections of Proint facilitate the corner connection between the wall covering and the floor, thus guaranteeing the expansion between the two surfaces.



PIA/9 silver anodised aluminium

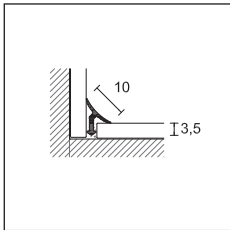

PIA/3



PROINT

length = 270 cm - pack 20 pcs

		H			
ART.	finishing	3,5	7	9	12
ALUMINIUM					
PIA/	silver anodised	95431	95430	95432	95429
<i>euro/m</i>					

individually packed

PROINT

length = 270 cm - pack 20 pcs

		H	
ART.	finishing	7	9
CO-EXTRUDED PVC			
	snow white	95396	95398
	white	95400	95402
	cream white RAL 9001	-	95406
	ivory RAL 1015	-	95418
PI/	beige grey RAL 1019	-	95410
	stone grey RAL 7030	-	95422
	ash grey RAL 7038	-	95433
	light grey RAL 7035	-	95414

pack 20 pcs
euro/m

pack 100 pcs
euro/m

no partial packaging - to order the pack of 100 pcs, mark /100 after article code

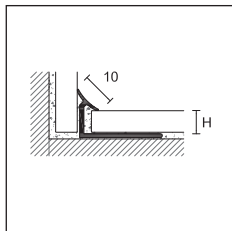

PI/
PI/

Complete the article code with H measure (for example PIA/ for H=7 becomes PIA/7)

Items PI/ available in different colours on demand - minimum quantity 2700 meters per colour



PI/9 white co-extruded PVC



PIA/3 silver anodised aluminium

cerfix® proround

Proround B in aluminium or PVC are perimetral connection profiles to be used between floors and walls, specially designed for the application on already-laid surfaces. These profiles are the best solution for renovations and to be compliant with hygienic regulations. BLAH/ boasts the certified antibacterial technology (in compliance with ISO 22196:2011 standards) which reduces the presence of the most dangerous bacteria up to 99%, thus assuring the best hygiene over time.



BLA/20 silver anodised aluminium

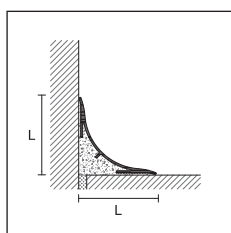

BLA/
BLAH/

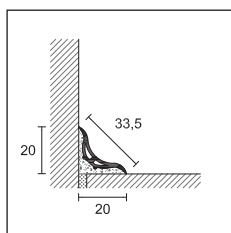

BL/20

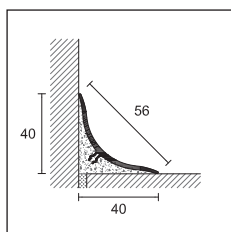

BL/40

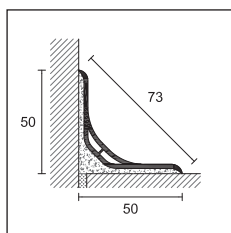

BL/50



polypropylene accessories

PROROUND B

length = 270 cm - pack 20 pcs

LxL

ART.	finishing	20x20	40x40	50x50
ALUMINIUM				
BLA/	silver anodised	95570	95580	-
	euro/m			-
ANTIBACTERIAL COLOUR-COATED ALUMINIUM				
BLAH/	colour-coated white RAL 9003 antibacterial	95572	95582	-
	euro/m			-

individually packed

PROROUND B

length = 270 cm - pack 20 pcs

LxL

ART.	finishing	20x20	40x40	50x50
PVC				
BL/	white	95550	95500	95551
	euro/m			

POLYPROPYLENE ACCESSORIES PACK

8 pcs

4 pcs

4 pcs

OUTSIDE CORNER IN POLYPROPYLENE

GBL/ /E	silver	95574	95584	-
	white	95556	95510	95552
	euro/pc			

INSIDE CORNER IN POLYPROPYLENE

GBL/ /I	silver	95576	95586	-
	white	95557	95512	95553
	euro/pc			

TRIAXIAL CORNER IN POLYPROPYLENE

GBL/ /T	silver	-	95588	-
	white	-	95511	95554
	euro/pc	-		

RIGHT-LEFT END CAPS IN POLYPROPYLENE

GBL/ /C	silver	95578	95590	-
	white	95558	95513	95555
	euro/pc			

no partial packaging - article GBL/ /C pack of 16 pcs (20x20) and 8 pcs (40x40 and 50x50)

Complete the article code with L measure (for example BLA/ for L= 20 becomes BLA/20)

Proround B in stainless steel are perimetral connection profiles to be used between floors and walls, specially designed for the application on already-laid surfaces. These profiles are the best solution for renovations and to be compliant with hygienic regulations.

Stainless steel is particularly resistant to the attack of organic and inorganic agents and, therefore, it is suitable in spaces such as hospitals, food and chemical industries.



BI/40 stainless steel AISI 304 DIN 1.4301

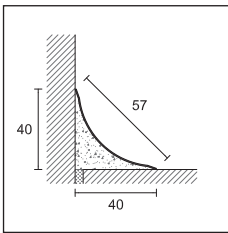

BI/40
BI/40/A



PROROUND B

length = 270 cm - pack 20 pcs

LxL

ART. finishing 40x40

STAINLESS STEEL

BI/40	stainless steel AISI 304 DIN 1.4301 <i>euro/m</i>		94992
BI/40/A adhesive	stainless steel AISI 304 DIN 1.4301 <i>euro/m</i>		94993

POLYPROPYLENE MATCHING CHROMIUM FINISH PACK 4 PCS

OUTSIDE CORNER IN POLYPROPYLENE

GTL/E	polypropylene chromium effect <i>euro/pc</i>		95515
--------------	--	--	-------

INSIDE CORNER IN POLYPROPYLENE

GTL/I	polypropylene chromium effect <i>euro/pc</i>		95517
--------------	--	--	-------

TRIAXIAL CORNER IN POLYPROPYLENE

GTL/T	polypropylene chromium effect <i>euro/pc</i>		95516
--------------	--	--	-------

RIGHT-LEFT END CAPS IN POLYPROPYLENE

GTL/C	polypropylene chromium effect <i>euro/pc</i>		95518
--------------	--	--	-------

no partial packaging





linear shower drains and systems for bathrooms

Profilpas offers a wide range of solutions for bathrooms which combine functionality and modern design. In particular, Profilpas bathroom systems allow the creation of floor-level showers, with a wide selection of linear shower drains - like PP Drain Aqua, Thin Drain, Slim Drain and Smart Drain, all customizable with different grates - and Q-Drain, available in several models. Profilpas bathroom range also includes Glass Profile, a line of profiles for the insertion of glass walls and the finishing of the shower surface, designed to compensate the 2% slope.



PP Drain Aqua

PPdrain | Aqua

The linear shower drains PP Drain Aqua, made of stainless steel AISI 316 and provided with a patented removable siphon in antibacterial ABS, are a perfect synthesis of beauty and practicality. Profilpas has taken care of every aspect of their design, production and quality control, to offer a product that is always efficient and aesthetically perfect.

The linear shower drains PP Drain Aqua, composed of a single piece without welds, distinguish for their design and functionality that make them elegant, simple to install and easy to clean. Each part of the shower drain is studied in detail, to contain in few components all that is needed to guarantee the maximum ease of installation and maintenance.

Aesthetics



Elegant and exclusive design, customisable with a wide range of covers and finishes.

Removable siphon

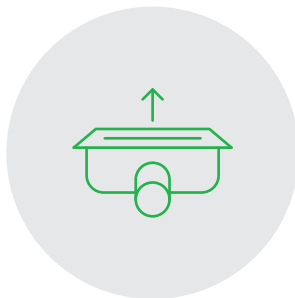

The siphon is simple to remove and can be easily inspected, for the maximum efficiency.

Ease of installation



The assembly and the adjustment of the shower drain are simplified, for a simple and quick installation.

Cleanliness and hygiene



The removable siphon in antibacterial ABS simplifies the maintenance and allows a quick and efficient cleanliness.



PP Drain Aqua

The essentiality of the linear shape of the shower drain, combined to the beauty of the multiple finishes, allows to offer an aesthetically perfect solution, able to adapt to any kind of design and to any material (porcelain stoneware, marble, mosaic, natural stone...).

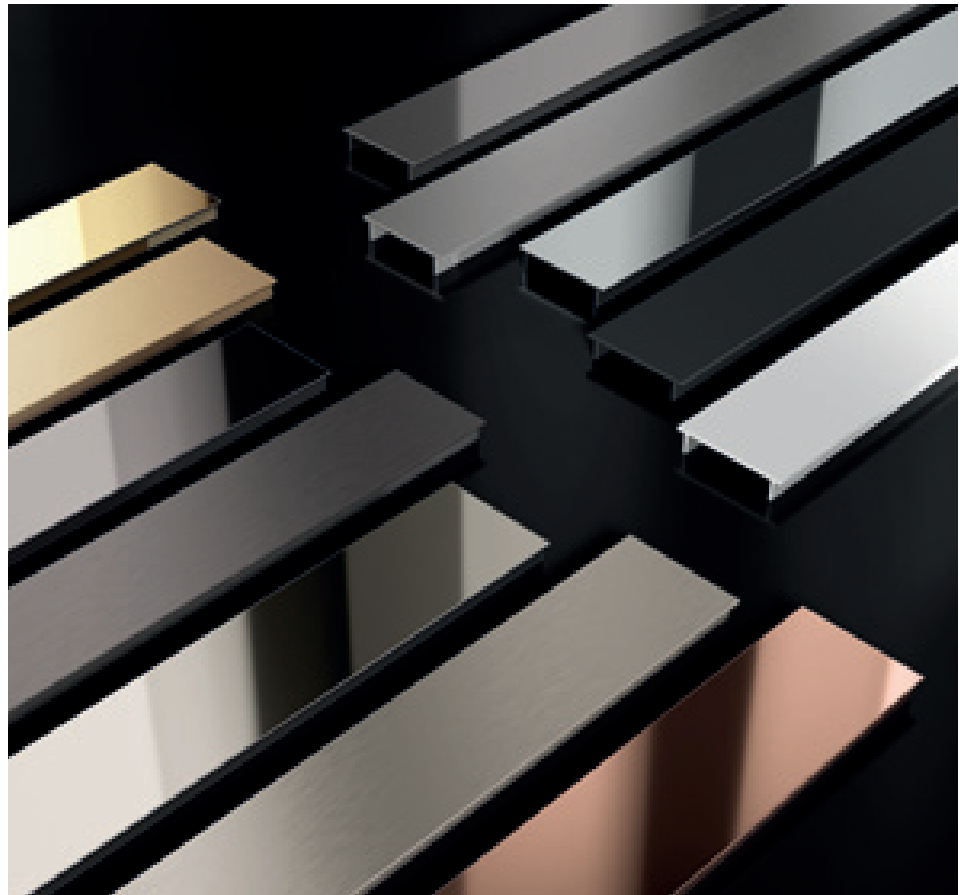

PP Drain Aqua

With PP Drain Aqua linear shower drains, maintenance and cleaning are fully simplified. The siphon, made of antibacterial ABS, can be removed and inspected completely. Furthermore, the AISI 316 stainless steel shower drain base is composed of a single piece without welds and sharp edges for the best hygiene and efficiency. Studied to minimize installation times, they are equipped with a pre-glued waterproofing membrane, supports from 6 to 18 mm for the height adjustment of the covers and bases in polystyrene foam.



PP Drain Aqua



PP DRAIN AQUA - shower drain base with siphon

		L					
ART.	finishing	60 cm	70 cm	80 cm	90 cm	100 cm	120 cm
STAINLESS STEEL							
PP/	stainless steel AISI 316 DIN 1.4404 euro/pc		22100	22101	22102	22103	22104 22105

PP DRAIN AQUA - shower drain base with direct drainage diam. 50 mm

		L					
ART.	finishing	60 cm	70 cm	80 cm	90 cm	100 cm	120 cm
STAINLESS STEEL							
PP50/	stainless steel AISI 316 DIN 1.4404 euro/pz		22106	22107	22108	22109	22110 22111

Shower drain base with direct drainage diam. 40 mm available upon request.

NEW PP DRAIN AQUA 360 - shower drain base with 360° swivelling siphon

		L					
ART.	finishing	60 cm	70 cm	80 cm	90 cm	100 cm	120 cm
STAINLESS STEEL							
PP360/	stainless steel AISI 316 DIN 1.4404 euro/pz		22180	22181	22182	22183	22184 22185

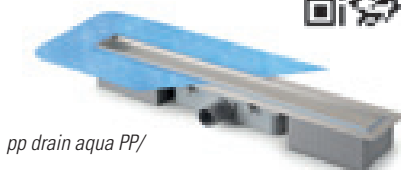

pp drain aqua PP/

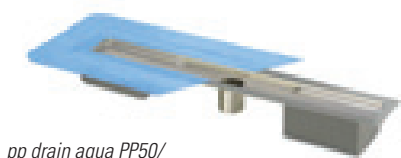

pp drain aqua PP50/



pp drain aqua PP360/

cover¹

frame²

ABS supports

hair catcher filter

removable top in antibacterial ABS

removable siphon in antibacterial ABS

waterproofing membrane

single-piece base in stainless steel AISI 316

base in polystyrene

drain in antibacterial ABS

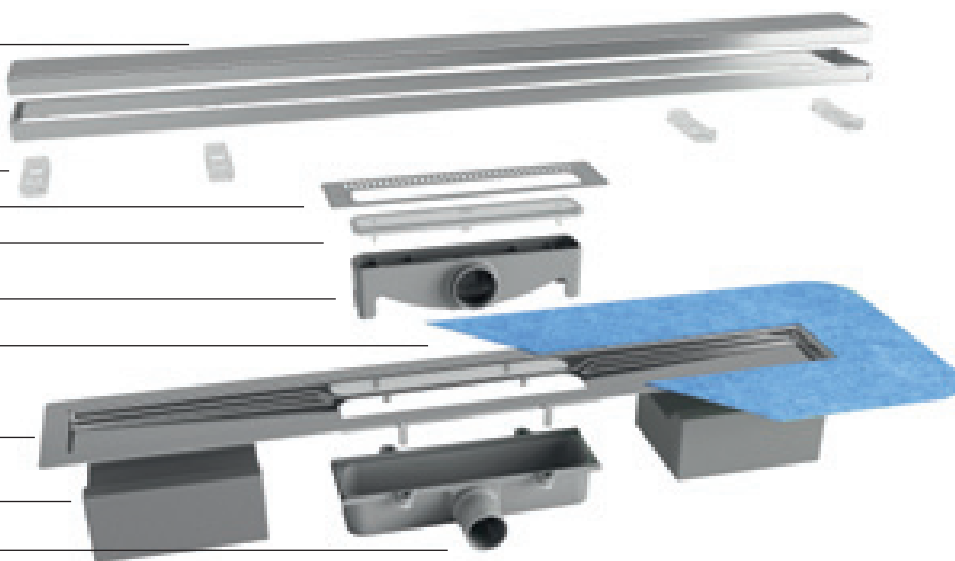

¹ Different types of cover available.

² The frame is present in Classic Cover model. The other covers are not equipped with frame.

Complete the article code with L measure (for example PP/ for L = 70 becomes PP/70)

Classic Cover, in polished or brushed stainless steel AISI 316, is available in different lengths (from 60 to 120 cm). It includes the frame and the adjustment supports from 6 to 18 mm, and it is reversible: if turned upside down, it becomes tileable (up to 12 mm), thus creating aesthetic continuity with the bathroom covering.



PP Drain Aqua - Classic Cover polished stainless steel AISI 316 - DIN 1.4404

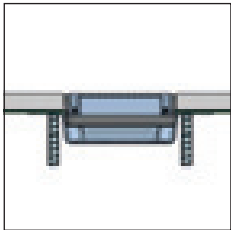

Classic Cover

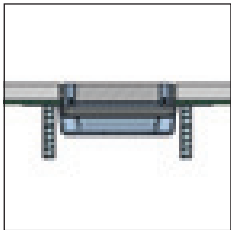



Classic Cover tileable



Classic Cover brushed stainless steel AISI 316 DIN 1.4404

CLASSIC COVER - tiles thickness from 6 to 18 mm

		L						
ART.	finishing	60 cm	70 cm	80 cm	90 cm	100 cm	120 cm	
STAINLESS STEEL								
XPC/	polished stainless steel AISI 316 DIN 1.4404		22112	22113	22114	22115	22116	22117
	brushed stainless steel AISI 316 DIN 1.4404		22118	22119	22120	22121	22122	22123
euro/pc								

Classic Cover is reversible, if turned upside down it becomes tileable (with a thickness up to 12 mm).



PP Drain Aqua - Design Cover brushed stainless steel AISI 316 DIN 1.4404

Complete the article code with L measure (for example XPC/ for L = 70 becomes XPC/70)

PP Drain Aqua

Flat Cover, available in several finishes and different lengths (from 60 to 120 cm), stands out for the perfectly flat and linear design. It is provided with adjustment supports that allow it to be adapted to tiles with thickness from 6 to 18 mm.



PP Drain Aqua - Flat Cover matt black colour-coated aluminium

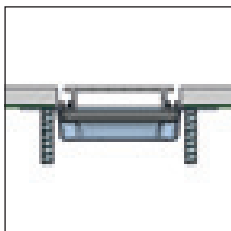

Flat Cover aluminium

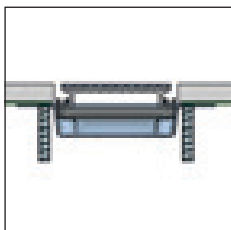

Flat Cover aluminium + stainless steel

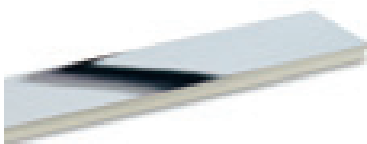

Flat Cover chromium-plated stainless steel

FLAT COVER - tiles thickness from 6 to 18 mm

ART.	finishing	L						
		60 cm	70 cm	80 cm	90 cm	100 cm	120 cm	
ALUMINIUM + STAINLESS STEEL								
XPF/	polished stainless steel AISI 316 DIN 1.4404		22136	22137	22138	22139	22140	22141
	brushed stainless steel AISI 316 DIN 1.4404		22142	22143	22144	22145	22146	22147
<i>euro/pc</i>								
ALUMINIUM + CHROMIUM-PLATED STAINLESS STEEL								
XPF/	chromium-plated stainless steel AISI 316 DIN 1.4404		22261	22262	22263	22264	22265	-
<i>euro/pc</i>								
COLOUR-COATED ALUMINIUM								
XPF/	matt white		22148	22149	22150	22151	22152	-
	matt black		22154	22155	22156	22157	22158	-
<i>euro/pc</i>								
ALUMINIUM + STAINLESS STEEL								
XPF/	polished nickel		22226	22227	22228	22229	22230	-
	brushed nickel		22231	22232	22233	22234	22235	-
	polished pink gold		22236	22237	22238	22239	22240	-
	<i>euro/pc</i>							
	polished graphite		22241	22242	22243	22244	22245	-
	brushed graphite		22246	22247	22248	22249	22250	-
<i>euro/pc</i>								
XPF/	polished gold		22251	22252	22253	22254	22255	-
	brushed gold		22256	22257	22258	22259	22260	-
<i>euro/pc</i>								



Flat Cover

Complete the article code with L measure (for example XPF/ for L = 70 becomes XPF/70)

PP Drain Aqua

Design Cover stands out for the absolute elegance of its design and for the central drain. In polished or brushed stainless steel AISI 316, it is available in different lengths, from 60 to 120 cm.



PP Drain Aqua - Design Cover brushed stainless steel AISI 316 DIN 1.4404

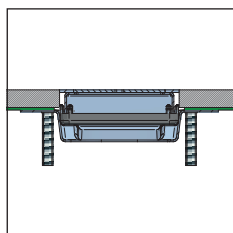



Design Cover



Design Cover

DESIGN COVER - tiles thickness from 6 to 18 mm

ART.	finishing	L						
		60 cm	70 cm	80 cm	90 cm	100 cm	120 cm	
STAINLESS STEEL								
XPD/	polished stainless steel AISI 316 DIN 1.4404		22214	22215	22216	22217	22218	22219
	brushed stainless steel AISI 316 DIN 1.4404		22220	22221	22222	22223	22224	22225
euro/pc								

With Invisible Cover, the shower tray and the linear shower drain become as one and blend perfectly with the bathroom covering. In natural aluminium and different lengths (from 60 to 120 cm), it disappears under the tile for a completely invisible aesthetic effect.

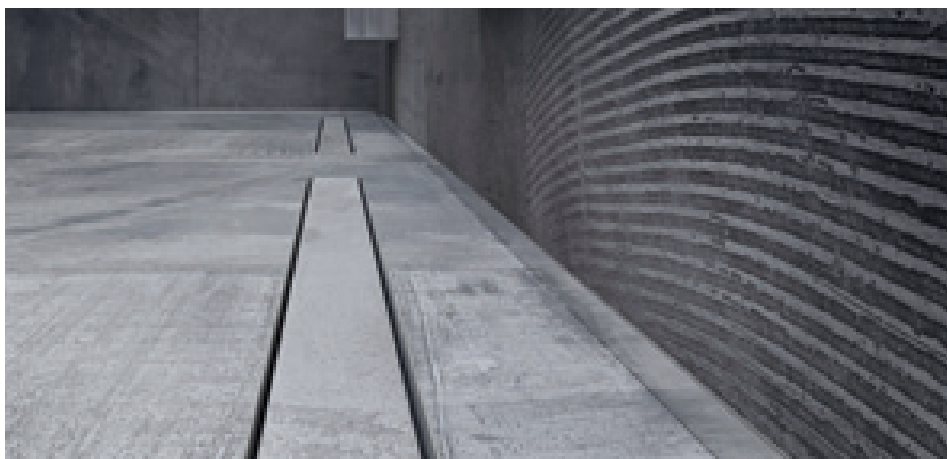

PP Drain Aqua - Invisible Cover

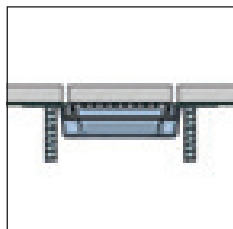

Invisible Cover



Invisible Cover

INVISIBLE COVER

ART.	finishing	L						
		60 cm	70 cm	80 cm	90 cm	100 cm	120 cm	
ALUMINIUM								
XPI/	natural aluminium		22130	22131	22132	22133	22134	22135
euro/pc								

Complete the article code with L measure
(for example XPD/ for L = 70 becomes XPD/70)

thin drain

thindrain

Thin Drain is a line of flush with the floor shower drains for a quick and easy installation, which allows to customize the shower with any kind of covering. Thanks to the syphon with low thickness and the height of the shower drain of just 55 mm, they are particularly suitable for refurbishments or in spaces where lightness and versatility are the main features.

ADVANTAGES

- Installation flush with the floor (it eliminates architectural barriers)
- Possibility of installation close to the wall
- Height of the shower drain of 55 mm (laying surface)
- Suitable for tiles with thickness up to 12 mm
- Possibility of laying tiles with thickness up to 12 mm with Tile Cover
- Shower drains with certification EN 1253-1 (minimum flow rate of 24 l/ min)
- Supports for quick installation
- Integrated waterproof membrane to reduce the risk of seepages
- Possibility of inspection of the syphon for periodic cleaning
- Filter for cleaning/hair
- Quick installation
- Drain adapter from 4 to 50 mm included

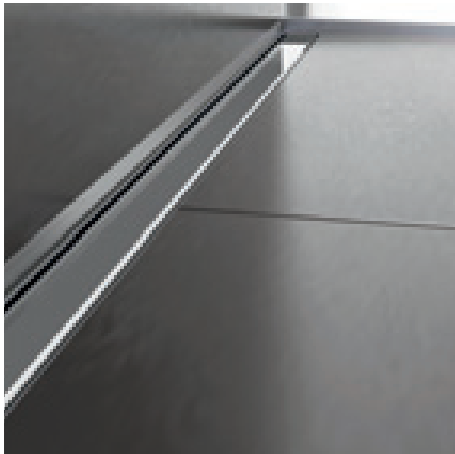

classic cover - polished stainless steel AISI 304 - DIN 1.4301

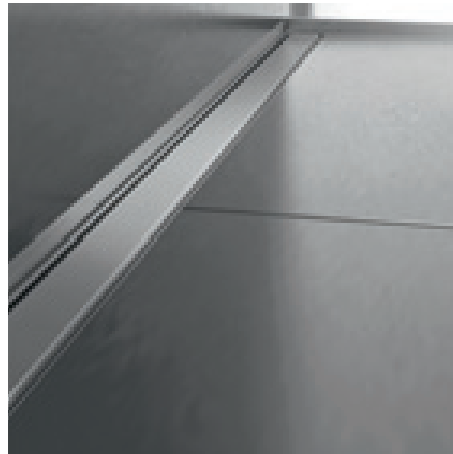

classic cover - brushed stainless steel AISI 304 - DIN 1.4301

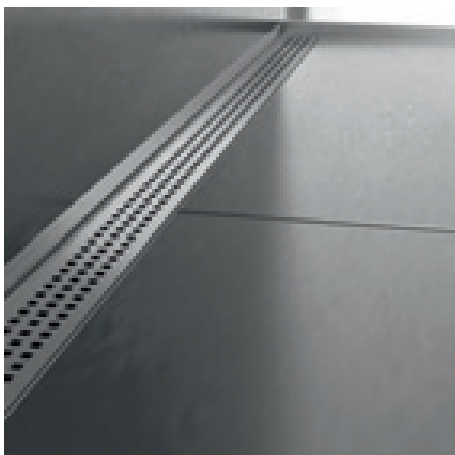

cube cover - brushed stainless steel AISI 304 - DIN 1.4301

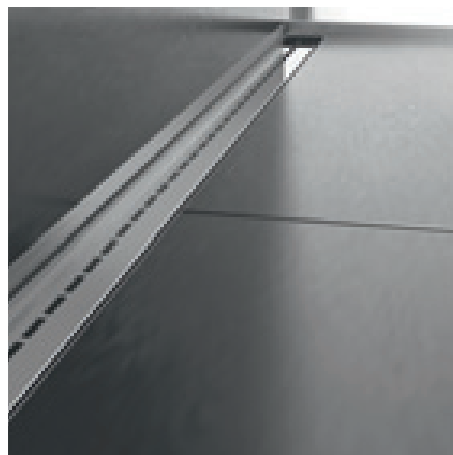

single line cover - polished stainless steel AISI 304 - DIN 1.4301



THIN DRAIN - BASE - pack 10 pcs

ART.	finishing		60 cm	70 cm	80 cm	90 cm	100 cm	120 cm
STAINLESS STEEL								
THIN/	stainless steel AISI 304 DIN 1.4301		19400	19401	19402	19403	19404	19405
<i>euro/pc</i>								



CLASSIC COVER - pack 10 pcs

ART.	finishing		60 cm	70 cm	80 cm	90 cm	100 cm	120 cm
STAINLESS STEEL								
XTC/	brushed stainless steel AISI 304 DIN 1.4301		19410	19412	19414	19416	19418	19420
	polished stainless steel AISI 304 DIN 1.4301		19411	19413	19415	19417	19419	19421
<i>euro/pc</i>								



CUBE COVER - pack 10 pcs

ART.	finishing		60 cm	70 cm	80 cm	90 cm
STAINLESS STEEL						
XTCC/	brushed stainless steel AISI 304 DIN 1.4301		19430	19431	19432	19433
<i>euro/pc</i>						



SINGLE LINE COVER - pack 10 pcs

ART.	finishing		60 cm	70 cm	80 cm	90 cm
XTL/	polished stainless steel AISI 304 DIN 1.4301		19440	19441	19442	19443
<i>euro/pc</i>						



TILE COVER - pack 10 pcs

ART.	finishing		60 cm	70 cm	80 cm	90 cm
XTT/	stainless steel AISI 304 DIN 1.4301		19450	19451	19452	19453
<i>euro/pc</i>						

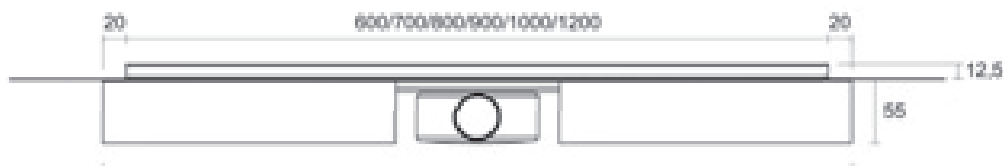
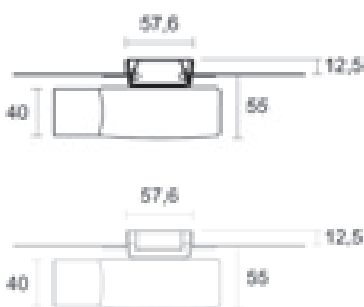
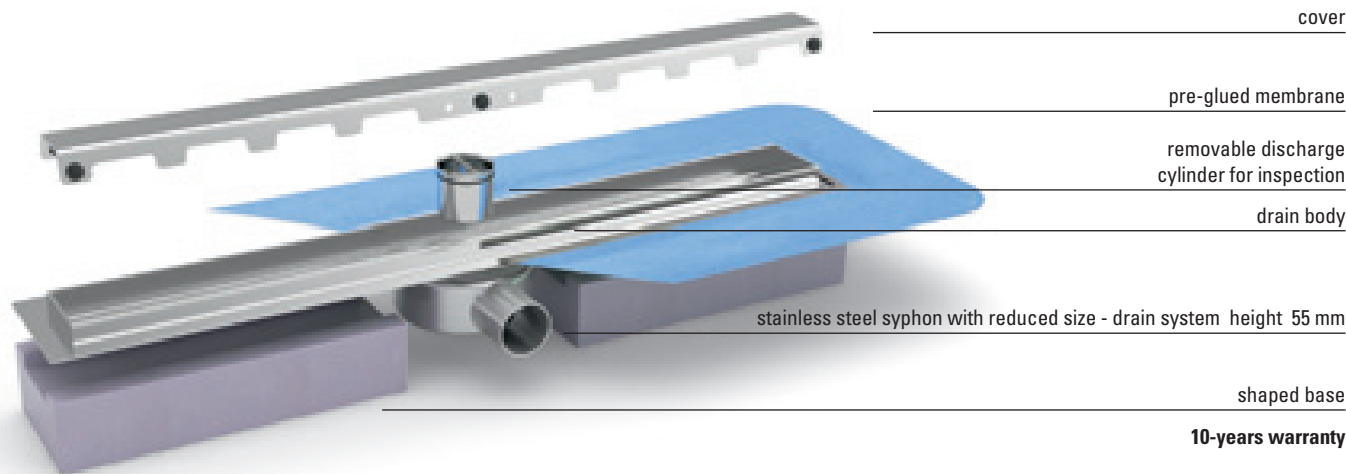

slim drain

slimdrain

Slim Drain is a line of flush with the floor shower drains for a quick and easy installation, which allows to customize the shower with any kind of covering and any tile thickness by choosing Slim Drain Invisible. Thanks to the syphon with low thickness and the height of the shower drain of just 65 mm, they are particularly suitable for refurbishments or in spaces where lightness and versatility are the main features.

ADVANTAGES

- Installation flush with the floor (it eliminates architectural barriers)
- Possibility of installation close to the wall
- Height of the shower drain of 65 mm (laying surface)
- Suitable for any tile thickness (Slim Invisible version)
- Adjustable frame (thickness 7-12,5 mm), Slim Invisible excluded.
- Shower drains with certification EN 1253-1 (minimum flow rate of 24 l/min)
- Integrated adjusting supports for an easy levelling
- Integrated waterproof membrane to reduce the risk of seepages
- Possibility of inspection of the syphon for periodic cleaning
- Filter for cleaning/hair
- Quick installation
- Drain adapter from 40 to 50 mm included

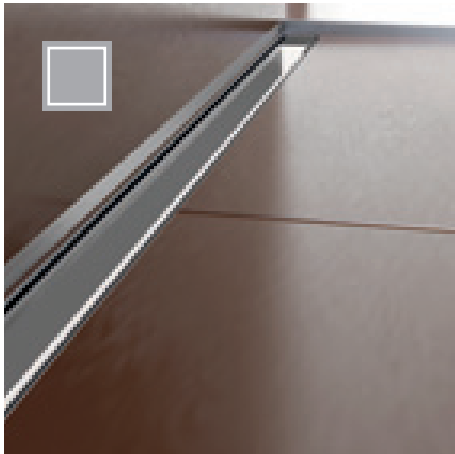

classic cover - polished stainless steel AISI 304 DIN 1.4301

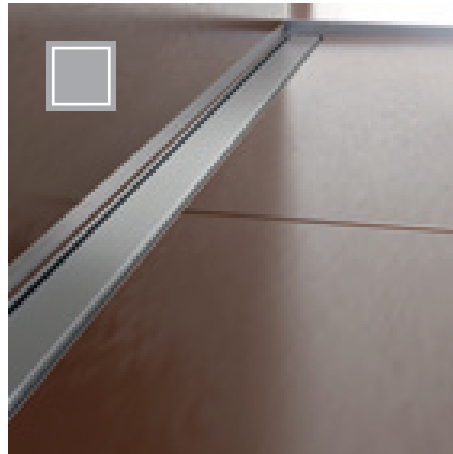

classic cover - brushed stainless steel AISI 304 DIN 1.4301

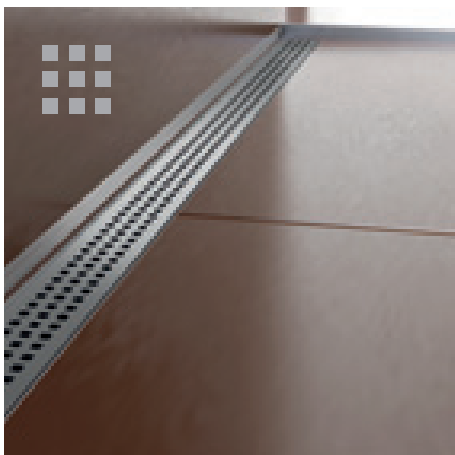

cube cover - brushed stainless steel AISI 304 DIN 1.4301

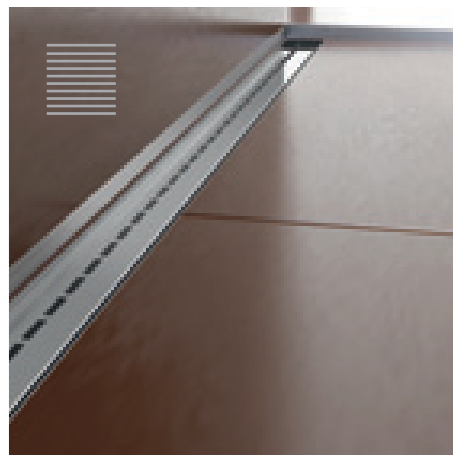

single line cover - polished stainless steel AISI 304 DIN 1.4301

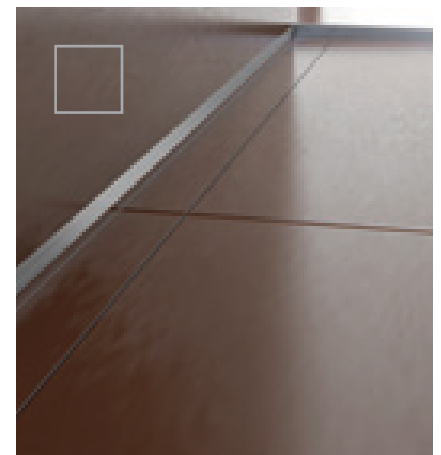

slim invisible - stainless steel AISI 304 DIN 1.4301



SLIM DRAIN - BASE - pack 10 pcs

ART.	finishing	60 cm	70 cm	80 cm	90 cm	100 cm	120 cm
STAINLESS STEEL							
SLIM/	stainless steel AISI 304 DIN 1.4301		19504	19506	19508	19510	19512
<i>euro/pc</i>							

CLASSIC COVER - pack 10 pcs

ART.	finishing	60 cm	70 cm	80 cm	90 cm	100 cm	120 cm
STAINLESS STEEL							
XSC/	brushed stainless steel AISI 304 DIN 1.4301		19524	19526	19528	19530	19532
	polished stainless steel AISI 304 DIN 1.4301		19523	19525	19527	19529	19531
<i>euro/pc</i>							

CUBE COVER - pack 10 pcs

ART.	finishing	60 cm	70 cm	80 cm	90 cm
STAINLESS STEEL					
XSCC/	brushed stainless steel AISI 304 DIN 1.4301		19544	19546	19548
<i>euro/pc</i>					

SINGLE LINE COVER - pack 10 pcs

ART.	finishing	60 cm	70 cm	80 cm	90 cm
XSL/	polished stainless steel AISI 304 DIN 1.4301		19563	19565	19567
<i>euro/pc</i>					

SLIM INVISIBLE - BASE + COVER - pack 10 pcs

ART.	finishing	60 cm	70 cm	80 cm	90 cm
SLIM-I/	stainless steel AISI 304 DIN 1.4301		19505	19507	19509
<i>euro/pc</i>					

Slim Invisible does not include the adjustable frame

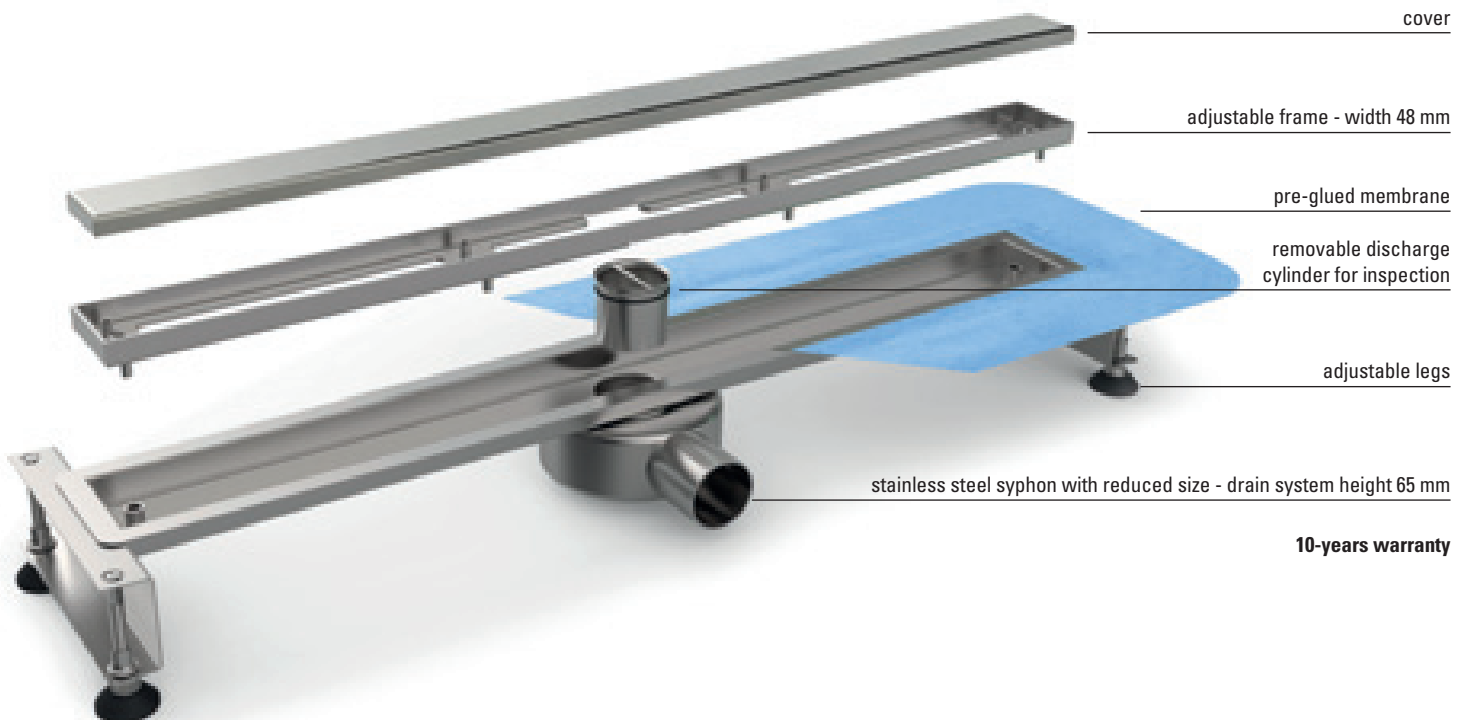
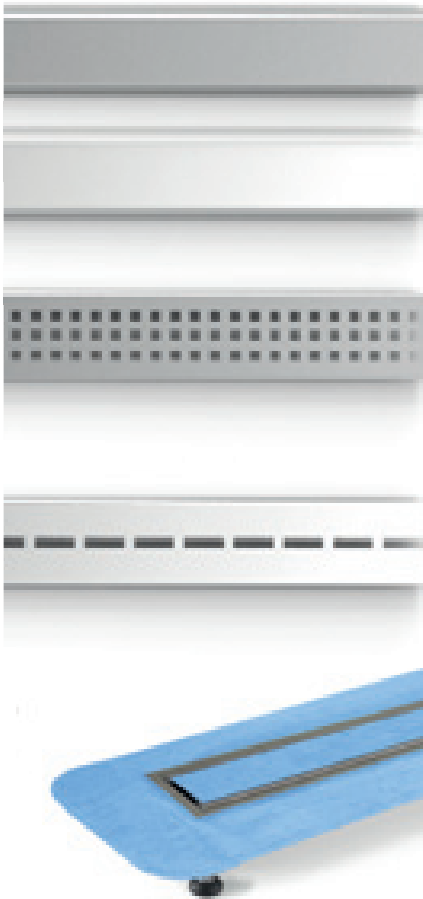

10-years warranty

smart drain

smartdrain

Smart Drain is a line of flush with the floor shower drains for a quick and easy installation, which allows to customize the shower with any kind of covering and any tile thickness by choosing Smart Drain Invisible. With high aesthetic level, varied sizes available and the height of the shower drain of 75 mm, they are particularly suitable for large size of tiles in every space.

ADVANTAGES

- Installation flush with the floor (it eliminates architectural barriers)
- Possibility of installation close to the wall
- Height of the shower drain of 75 mm (laying surface)
- Suitable for tiles with every tiles thickness (Smart Invisible version)
- Adjustable frame (thickness 7-12,5 mm), excluded Smart Invisible.
- Orientable siphoned body.
- Shower drains with certification EN 1253-1 (minimum flow rate of 24 l/min)
- Integrated regular supports for a simple set - aside at the same level.
- Integrated waterproof membrane to reduce the risk of seepages
- Suitable Inox stain steel AISI 316 - DIN 14404 version
- 180° Ruotatable classic cover for tiles (maximum thickness 10 mm)
- Possibility of inspection of the syphon for periodic cleaning
- Filter for cleaning/hair
- Quick installation



classic cover - polished stainless steel AISI 304 DIN 1.4301

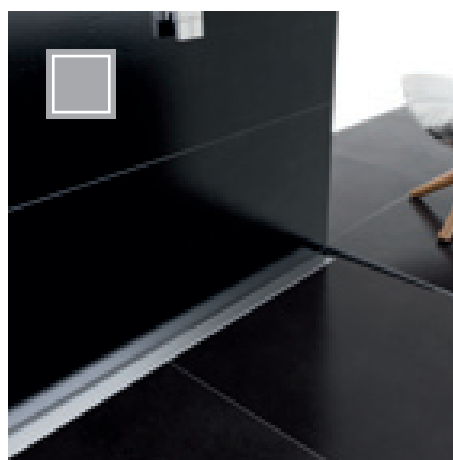

classic cover - brushed stainless steel AISI 304 DIN 1.4301

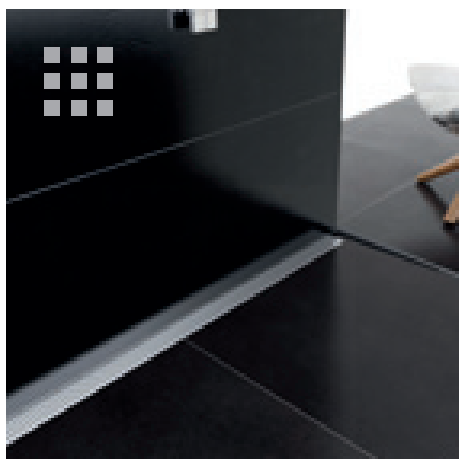

cube cover - brushed stainless steel AISI 304 DIN 1.4301



double line cover - polished stainless steel AISI 304 DIN 1.4301

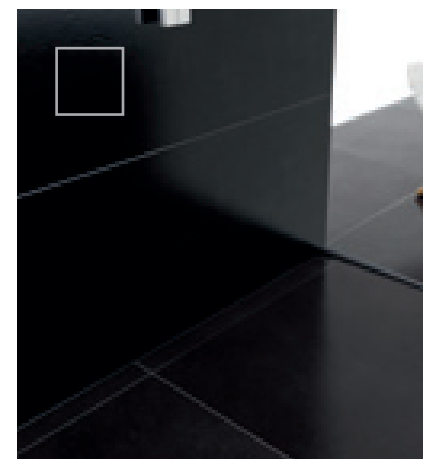

smart invisible - stainless steel AISI 304 DIN 1.4301



SMART DRAIN - BASE - pack 10 pcs

ART.	finishing		70 cm	80 cm	90 cm	100 cm	110 cm	120 cm
STAINLESS STEEL								
SMART/	stainless steel AISI 304 DIN 1.4301		19704	19706	19708	19710	19712	19714
	<i>euro/pc</i>							
SMART3/	stainless steel AISI 316 DIN 1.4404		19715	19716	19717	19718	-	-
	<i>euro/pc</i>						-	-

CLASSIC COVER - pack 10 pcs

ART.	finishing		70 cm	80 cm	90 cm	100 cm	110 cm	120 cm
STAINLESS STEEL								
XLC/	brushed stainless steel AISI 304 DIN 1.4301		19724	19726	19728	19730	19732	19734
	polished stainless steel AISI 304 DIN 1.4301		19723	19725	19727	19729	19731	19733
	<i>euro/pc</i>							
XLC3/	brushed stainless steel AISI 316 DIN 1.4404		19741	19742	19743	19744	-	-
	<i>euro/pc</i>						-	-

CUBE COVER - pack 10 pcs

ART.	finishing		70 cm	80 cm	90 cm	100 cm	110 cm	120 cm
STAINLESS STEEL								
XLCC/	brushed stainless steel AISI 304 DIN 1.4301		19764	19766	19768	19770	19772	19774
	<i>euro/pc</i>							

DOUBLE LINE COVER - pack 10 pcs

ART.	finishing		70 cm	80 cm	90 cm	100 cm	110 cm	120 cm
STAINLESS STEEL								
XLL/	polished stainless steel AISI 304 DIN 1.4301		19783	19785	19787	19789	19791	19793
	<i>euro/pc</i>							

SMART INVISIBLE - BASE + COVER - pack 10 pcs

ART.	finishing		70 cm	80 cm	90 cm	100 cm	110 cm	120 cm
STAINLESS STEEL								
SMART-I/	stainless steel AISI 304 DIN 1.4301		19703	19705	19707	19709	19711	19713
	<i>euro/pc</i>							

Smart Invisible does not include the adjustable frame

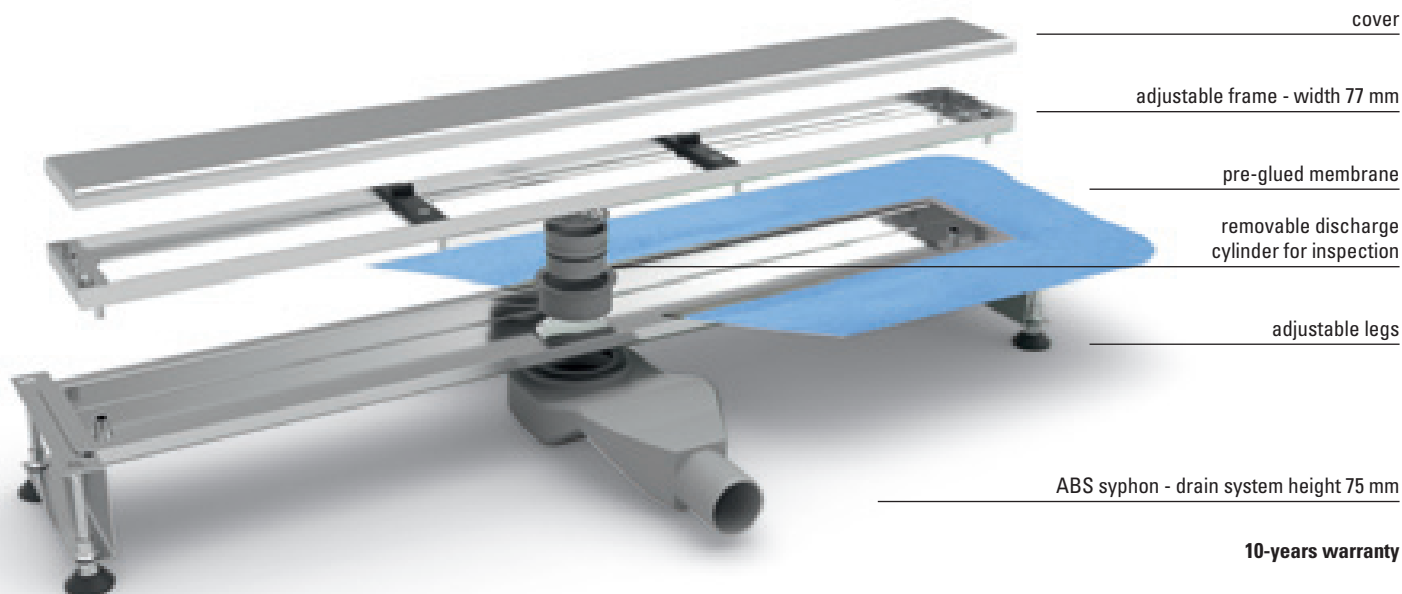

10-years warranty

Q drain

q-drain

Q-Drain is a line of point drainages for flush with the floor showers which are quick and easy to install and allow to customize the shower with any kind of covering. Provided with insulating flange and with a height of 72/78 mm, they are the ideal solution for traditional showers flush with the floor.

ADVANTAGES

- Installation flush with the floor (it eliminates architectural barriers)
- Height of the point drainage of 72/78 mm (laying surface)
- Directable syphon
- Shower drains with certification EN 1253-1 (minimum flow rate of 24 l/ min)
- Integrated waterproof membrane to reduce the risk of seepages
- Possibility of laying tiles with thickness up to 10 mm with Q Drain Tile
- Possibility of inspection of the syphon for periodic cleaning
- Filter for cleaning/hair
- Quick installation

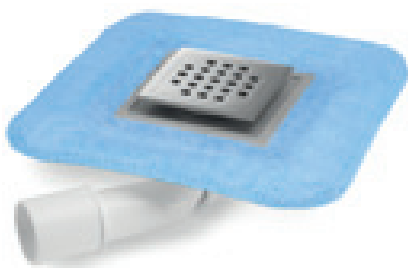

Q Drain Cube

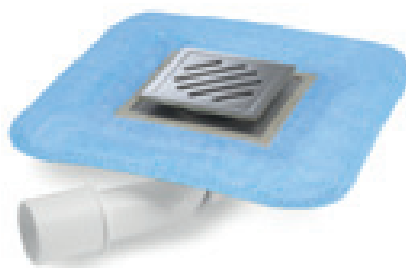

Q Drain Line



Q DRAIN CLASSIC - pack 10 pcs

ART.	finishing	10x10 cm
STAINLESS STEEL		
floor thickness of 12,5 mm		
QDC/1010	brushed stainless steel AISI 304 DIN 1.4301	19850
	polished stainless steel AISI 304 DIN 1.4301	19851
<i>euro/pc</i>		

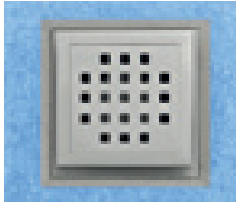

Q DRAIN CUBE - pack 10 pcs

ART.	finishing	10x10 cm
STAINLESS STEEL		
floor thickness of 12,5 mm		
QDCC/1010	brushed stainless steel AISI 304 DIN 1.4301	19852
	polished stainless steel AISI 304 DIN 1.4301	19853
<i>euro/pc</i>		



Q DRAIN LINE - pack 10 pcs

ART.	finishing	10x10 cm
STAINLESS STEEL		
floor thickness of 12,5 mm		
QDL/1010	brushed stainless steel AISI 304 DIN 1.4301	19854
	polished stainless steel AISI 304 DIN 1.4301	19855
<i>euro/pc</i>		

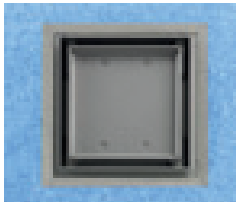

Q DRAIN TILE - pack 10 pcs

ART.	finishing	10x10 cm
STAINLESS STEEL		
floor thickness of 10 mm		
QDI/1010	stainless steel AISI 304 DIN 1.4301	19856
<i>euro/pc</i>		

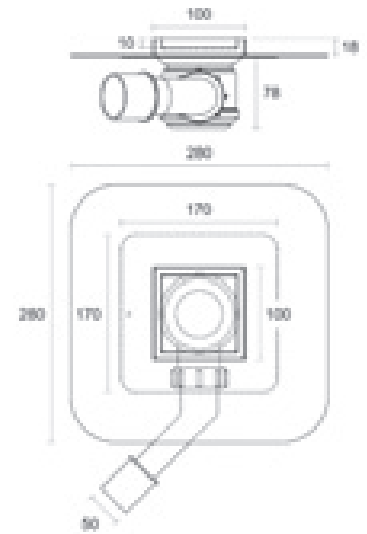
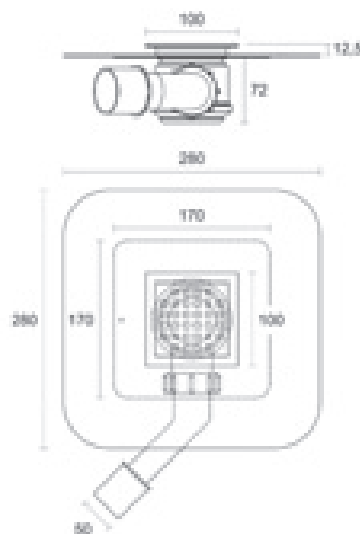
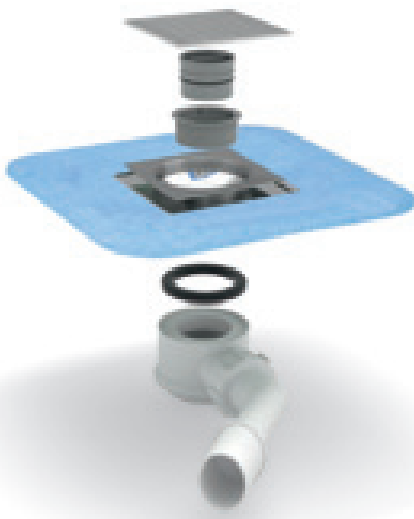

10-years warranty

Glass Profile

The floor-level shower is a trendy and design element that represents a real opportunity for designing bathrooms of every dimension, highlighting their practicality and beauty. Removing the traditional shower tray, the floor-level shower can be made with the same covering of the bathroom, thus creating a uniform and elegant surface. Moreover, the absence of architectural barriers makes the access easier for children, elderly people or disabled.

Profilpas offers a series of integrated solutions for floor-level showers: a system of linear floor-level drains in stainless steel, with the possibility of also opting for the invisible version, thus creating a whole with the shower ceramic covering, which is completed by a wide range of stainless steel profiles for the insertion of glass walls and for finishing the sloping surface.



Glass Profile is a line of stainless steel profiles designed to cover the difference in height of the surface with 2% slope and create a coplanar surface with a modern and linear design. The range includes two finishes: brushed stainless steel and matt black colour coated stainless steel. The versatility of these two colours become guarantee of elegance, assuring a minimalist and trendy effect.

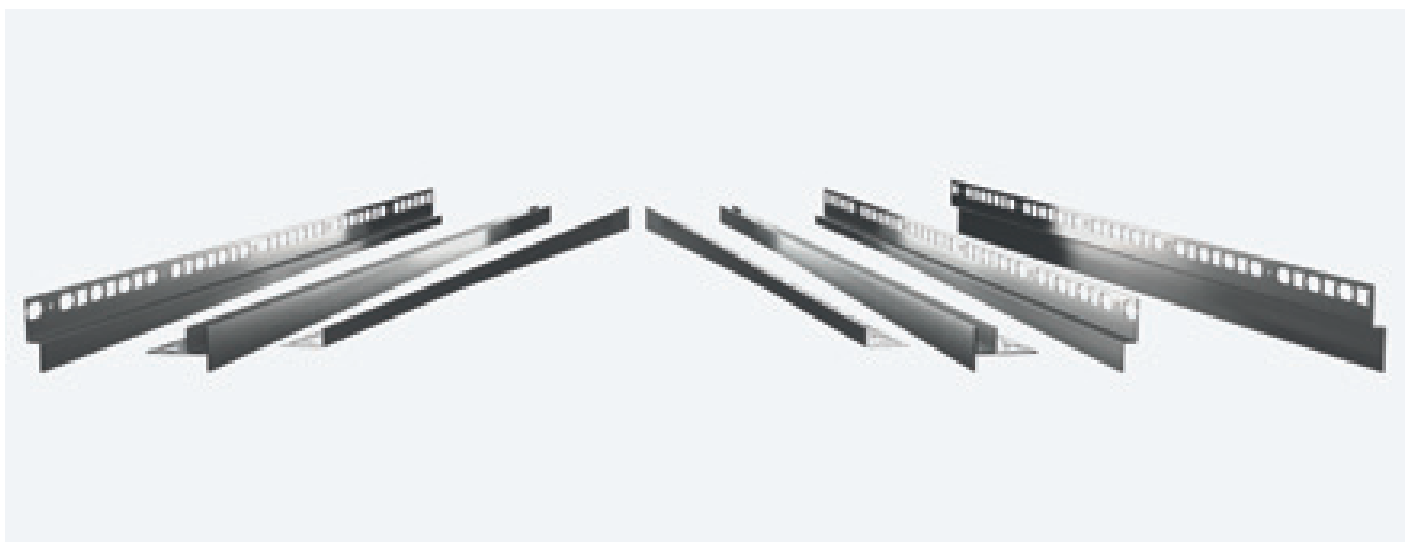

glass profile

Glass Profile GPS1/ is a stainless steel profile for the insertion of glass walls of floor-level showers. GPS1/ is provided with a 2% slope on the shower inner side for a perfect aesthetic solution of the sloped surface.

On completion of the profile, there is GPS/6, the end cap for hiding the section of the glass wall.

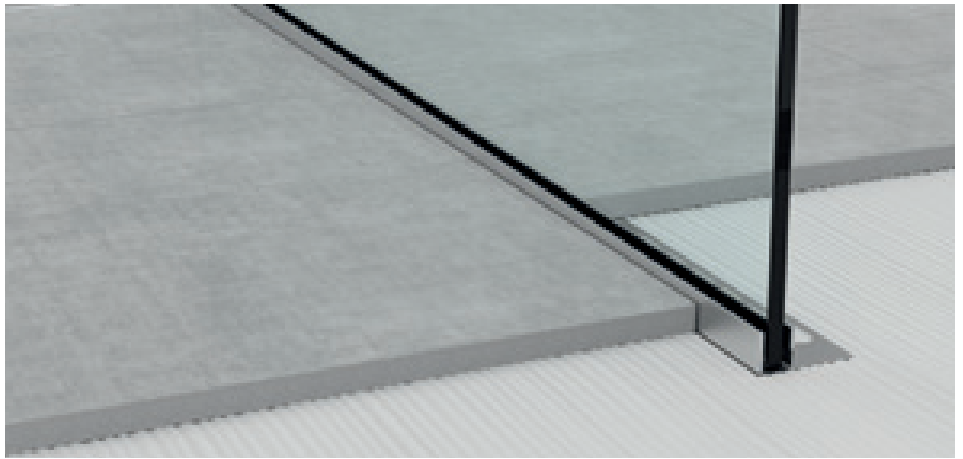

GPS1/DX/19 brushed stainless steel AISI 304 DIN 1.4301

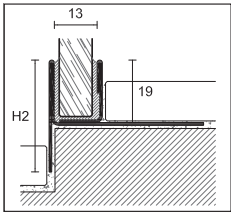

GPS1/DX/19

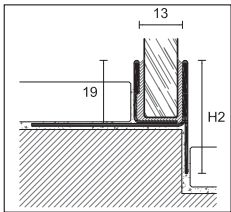

GPS1/SX/19

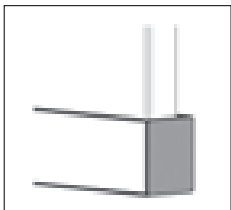

GPS/6

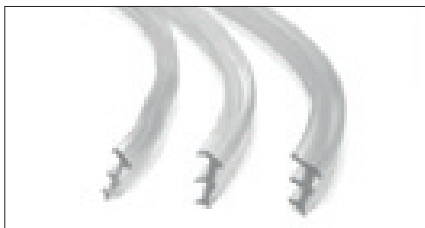

silicone glazing beads

GLASS PROFILE

pack 5 pcs

ART.	GPS1/ /19							
	DX		SX		DX		SX	
length cm	98		120		148		200	
H2 mm	34		37		42		60	

STAINLESS STEEL

brushed stainless steel AISI 304 DIN 1.4301		31505	31507	31515	31517	31525	31527	31535	31537
---	--	-------	-------	-------	-------	-------	-------	-------	-------

euro/pc

MATT BLACK COLOUR-COATED STAINLESS STEEL

matt black RAL 9005 colour-coated stainless steel AISI 304 DIN 1.4301		31506	31508	31516	31518	31526	31528	-	-
---	--	-------	-------	-------	-------	-------	-------	---	---

euro/pc

individually packed

GLASS PROFILE - END CAP FOR GPS1/ /19

pack 5 pcs

ART.	GPS/6
------	-------

STAINLESS STEEL

brushed stainless steel AISI 304 DIN 1.4301		31564
---	--	-------

euro/pc

MATT BLACK COLOUR-COATED STAINLESS STEEL

matt black RAL 9005 colour-coated stainless steel AISI 304 DIN 1.4301		31566
---	--	-------

euro/pc

no partial packaging

TRANSPARENT SILICONE GLAZING BEADS

pack 5 mt

ART.	measures	
GG/2	thickness 2 mm	31590
	euro/pack	
GG/3	thickness 3 mm	31592
	euro/pack	
GG/4	thickness 4 mm	31594
	euro/pack	

no partial packaging

Complete the article code with DX and SX (DX = RH and SX = LH) - for example GPS1//19 RH becomes GPS1/DX/19.

Glass Profile GPS2/ and GPS14/12 are two stainless steel profiles for inserting glass walls on the wall covering. GPS2/ is simple to install, is suitable for tiles of any thickness and does not require drilling. GPS/6 is the end cap to complete the profile, to hide the visible section of the glass wall. GPS14/12 can be fixed directly onto the already-laid wall covering.



GPS2/19 brushed stainless steel AISI 304 DIN 1.4301

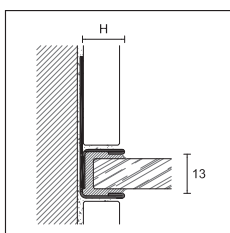

GPS2/



GLASS PROFILE

length = 210 cm - pack 5 pcs

ART.	finishing	10	12,5	19
------	-----------	----	------	----

STAINLESS STEEL

GPS2/	brushed stainless steel AISI 304 DIN 1.4301		31541	31542	31543
	<i>euro/pc</i>				

MATT BLACK COLOUR-COATED STAINLESS STEEL

GPS2/	matt black RAL 9005 colour-coated stainless steel AISI 304 DIN 1.4301		31546	31547	31545
	<i>euro/pc</i>				

individually packed

GLASS PROFILE

length = 250 cm - pack 5 pcs

ART.	finishing	10	12,5	19
------	-----------	----	------	----

STAINLESS STEEL

GPS2/	brushed stainless steel AISI 304 DIN 1.4301		31548	31549	31544
	<i>euro/pc</i>				

individually packed

GLASS PROFILE - END CAP FOR GPS2/19

pack 5 pcs

ART.	GPS/6
------	-------

STAINLESS STEEL

	brushed stainless steel AISI 304 DIN 1.4301		31564
	<i>euro/pc</i>		

MATT BLACK COLOUR-COATED STAINLESS STEEL

	matt black RAL 9005 colour-coated stainless steel AISI 304 DIN 1.4301		31566
	<i>euro/pc</i>		

no partial packaging

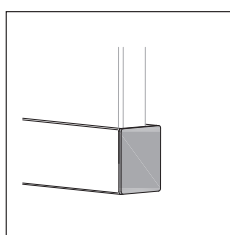

GPS/6

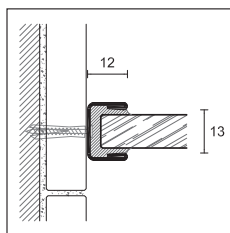

GPS14/12



GLASS PROFILE

pack 5 pcs

ART.	GPS14/12
------	----------

STAINLESS STEEL

	length cm	210	250	
	brushed stainless steel AISI 304 DIN 1.4301		32000	32001
	<i>euro/pc</i>			

individually packed

Complete the article code with H measure (for example GPS2/ for H=10 becomes GPS2/10).

glass profile

Glass Profile GPS3/ is a stainless steel profile provided with a 2% slope on the shower inner side for a perfect aesthetic solution of the sides of the sloped surface.

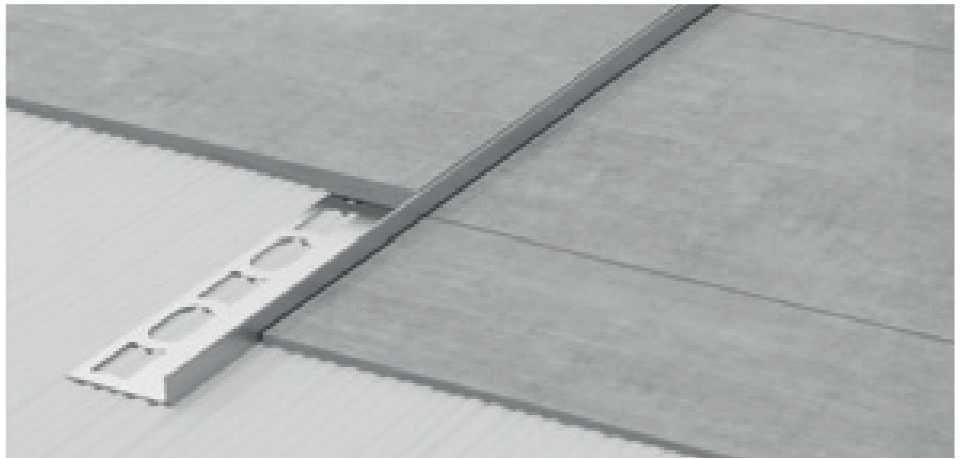

GPS3/SX/10 brushed stainless steel AISI 304 DIN 1.4301

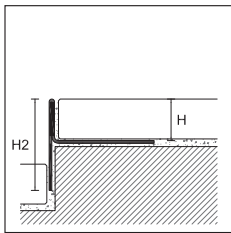

GPS3/DX/

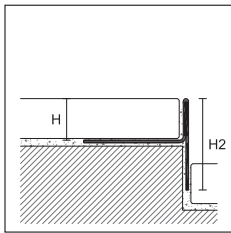







GPS3/SX/



GLASS PROFILE







length = 98 cm - pack 5 pcs

ART.	finishing		H	H2	DX	SX
STAINLESS STEEL						
GPS3/ /10	brushed stainless steel AISI 304 DIN 1.4301 <i>euro/pc</i>		10	25	31615	31617
GPS3/ /11	brushed stainless steel AISI 304 DIN 1.4301 <i>euro/pc</i>		11	26	31619	31620
GPS3/ /12	brushed stainless steel AISI 304 DIN 1.4301 <i>euro/pc</i>		12,5	27,5	31625	31627
MATT BLACK COLOUR-COATED STAINLESS STEEL						
GPS3/ /10	matt black RAL 9005 colour-coated stainless steel AISI 304 DIN 1.4301 <i>euro/pc</i>		10	25	31616	31618
GPS3/ /11	matt black RAL 9005 colour-coated stainless steel AISI 304 DIN 1.4301 <i>euro/pc</i>		11	26	31629	31630
GPS3/ /12	matt black RAL 9005 colour-coated stainless steel AISI 304 DIN 1.4301 <i>euro/pc</i>		12,5	27,5	31626	31628

individually packed

GLASS PROFILE

length = 120 cm - pack 5 pcs

ART.	finishing		H	H2	DX	SX
STAINLESS STEEL						
GPS3/ /10	brushed stainless steel AISI 304 DIN 1.4301 <i>euro/pc</i>		10	28	31645	31647
GPS3/ /11	brushed stainless steel AISI 304 DIN 1.4301 <i>euro/pc</i>		11	29	31649	31650
GPS3/ /12	brushed stainless steel AISI 304 DIN 1.4301 <i>euro/pc</i>		12,5	30,5	31655	31657
MATT BLACK COLOUR-COATED STAINLESS STEEL						
GPS3/ /10	matt black RAL 9005 colour-coated stainless steel AISI 304 DIN 1.4301 <i>euro/pc</i>		10	28	31646	31648
GPS3/ /11	matt black RAL 9005 colour-coated stainless steel AISI 304 DIN 1.4301 <i>euro/pc</i>		11	29	31652	31654
GPS3/ /12	matt black RAL 9005 colour-coated stainless steel AISI 304 DIN 1.4301 <i>euro/pc</i>		12,5	30,5	31656	31658







individually packed

GPS3/ is also available in 8 mm height on request, with a minimum order of 30 pcs.

Complete the article code with DX and SX (DX = RH and SX = LH) - for example GPS3/ /10 RH becomes GPS3/DX/10)

GLASS PROFILE



length = 148 cm - pack 5 pcs

ART.	finishing		H	H2	DX	SX
STAINLESS STEEL						
GPS3/ /10	brushed stainless steel AISI 304 DIN 1.4301 <i>euro/pc</i>		10	33	31675	31677
GPS3/ /11	brushed stainless steel AISI 304 DIN 1.4301 <i>euro/pc</i>		11	34	31679	31680
GPS3/ /12	brushed stainless steel AISI 304 DIN 1.4301 <i>euro/pc</i>		12,5	35,5	31685	31687
MATT BLACK COLOUR-COATED STAINLESS STEEL						
GPS3/ /10	matt black RAL 9005 colour-coated stainless steel AISI 304 DIN 1.4301 <i>euro/pc</i>		10	33	31676	31678
GPS3/ /11	matt black RAL 9005 colour-coated stainless steel AISI 304 DIN 1.4301 <i>euro/pc</i>		11	34	31682	31684
GPS3/ /12	matt black RAL 9005 colour-coated stainless steel AISI 304 DIN 1.4301 <i>euro/pc</i>		12,5	35,5	31686	31688

individually packed

GLASS PROFILE

length = 200 cm - pack 5 pcs

ART.	finishing		H	H2	DX	SX
STAINLESS STEEL						
GPS3/ /10	brushed stainless steel AISI 304 DIN 1.4301 <i>euro/pc</i>		10	51	31694	31695
GPS3/ /12	brushed stainless steel AISI 304 DIN 1.4301 <i>euro/pc</i>		12,5	53,5	31698	31699

individually packed



GPS3/DX/10 matt black RAL 9005 colour-coated stainless steel AISI 304 DIN 1.4301

glass profile

Glass Profile GPS4/ is a stainless steel profile provided with a 2% slope on the shower inner side. It connects the sloped floor and the covering perfectly, thus avoiding the oblique cut of the tiles.



GPS4/DX/10 matt black RAL 9005 colour-coated stainless steel AISI 304 DIN 1.4301

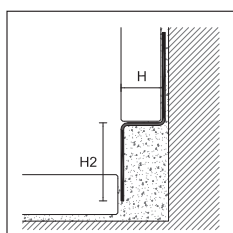

GPS4/DX/

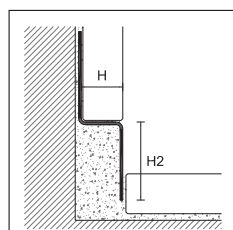

GPS4/SX/

GLASS PROFILE

length = 98 cm - pack 5 pcs

ART.	finishing	H	H2	DX	SX	
STAINLESS STEEL						
GPS4/ /10	brushed stainless steel AISI 304 DIN 1.4301		10	23	31715	31717
	<i>euro/pc</i>					
	brushed stainless steel AISI 304 DIN 1.4301		11	23	31716	31718
GPS4/ /11	<i>euro/pc</i>					
	brushed stainless steel AISI 304 DIN 1.4301		12,5	23	31725	31727
GPS4/ /12	<i>euro/pc</i>					

MATT BLACK COLOUR-COATED STAINLESS STEEL

GPS4/ /10	matt black RAL 9005 colour-coated stainless steel AISI 304 DIN 1.4301		10	23	31719	31720
	<i>euro/pc</i>					
	matt black RAL 9005 colour-coated stainless steel AISI 304 DIN 1.4301		11	23	31722	31724
GPS4/ /11	<i>euro/pc</i>					
	matt black RAL 9005 colour-coated stainless steel AISI 304 DIN 1.4301		12,5	23	31726	31728
GPS4/ /12	<i>euro/pc</i>					

individually packed

GLASS PROFILE

length = 120 cm - pack 5 pcs

ART.	finishing	H	H2	DX	SX	
STAINLESS STEEL						
GPS4/ /10	brushed stainless steel AISI 304 DIN 1.4301		10	26	31745	31747
	<i>euro/pc</i>					
	brushed stainless steel AISI 304 DIN 1.4301		11	26	31746	31748
GPS4/ /11	<i>euro/pc</i>					
	brushed stainless steel AISI 304 DIN 1.4301		12,5	26	31755	31757
GPS4/ /12	<i>euro/pc</i>					

GPS4/ is also available in 8 mm height on request, with a minimum order of 30 pcs.

Completare codice articolo con DX e SX (for example GPS4/ /8 DX becomes GPS4/DX/8)

MATT BLACK COLOUR-COATED STAINLESS STEEL

GPS4/ /10	matt black RAL 9005 colour-coated stainless steel AISI 304 DIN 1.4301 <i>euro/pc</i>	■	10	26	31749	31750
GPS4/ /11	matt black RAL 9005 colour-coated stainless steel AISI 304 DIN 1.4301 <i>euro/pc</i>	■	11	26	31752	31754
GPS4/ /12	matt black RAL 9005 colour-coated stainless steel AISI 304 DIN 1.4301 <i>euro/pc</i>	■	12,5	26	31756	31758

individually packed

GLASS PROFILE

length = 148 cm - pack 5 pcs

ART.	finishing		H	H2	DX	SX
STAINLESS STEEL						
GPS4/ /10	brushed stainless steel AISI 304 DIN 1.4301 <i>euro/pc</i>	▨	10	31	31775	31777
GPS4/ /11	brushed stainless steel AISI 304 DIN 1.4301 <i>euro/pc</i>	▨	11	31	31776	31778
GPS4/ /12	brushed stainless steel AISI 304 DIN 1.4301 <i>euro/pc</i>	▨	12,5	31	31785	31787

MATT BLACK COLOUR-COATED STAINLESS STEEL

GPS4/ /10	matt black RAL 9005 colour-coated stainless steel AISI 304 DIN 1.4301 <i>euro/pc</i>	■	10	31	31779	31780
GPS4/ /11	matt black RAL 9005 colour-coated stainless steel AISI 304 DIN 1.4301 <i>euro/pc</i>	■	11	31	31782	31784
GPS4/ /12	matt black RAL 9005 colour-coated stainless steel AISI 304 DIN 1.4301 <i>euro/pc</i>	■	12,5	31	31786	31800

individually packed

GLASS PROFILE

length = 200 cm - pack 5 pcs

ART.	finishing		H	H2	DX	SX
STAINLESS STEEL						
GPS4/ /10	brushed stainless steel AISI 304 DIN 1.4301 <i>euro/pc</i>	▨	10	49	31794	31795
GPS4/ /12	brushed stainless steel AISI 304 DIN 1.4301 <i>euro/pc</i>	▨	12,5	49	31798	31799

individually packed

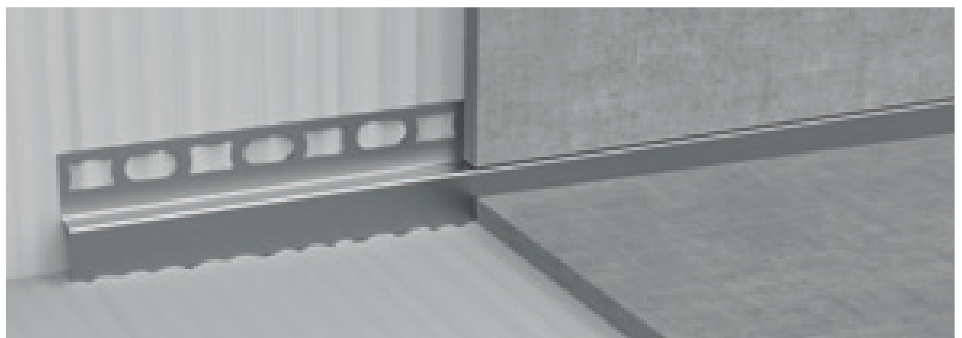

GPS4/SX/10 brushed stainless steel AISI 304 DIN 1.4301

glass profile

Glass Profile GPS5/ is a stainless steel profile to be positioned on the wall covering, above the shower drain with sloped surface, in order to avoid the cut of the tiles.

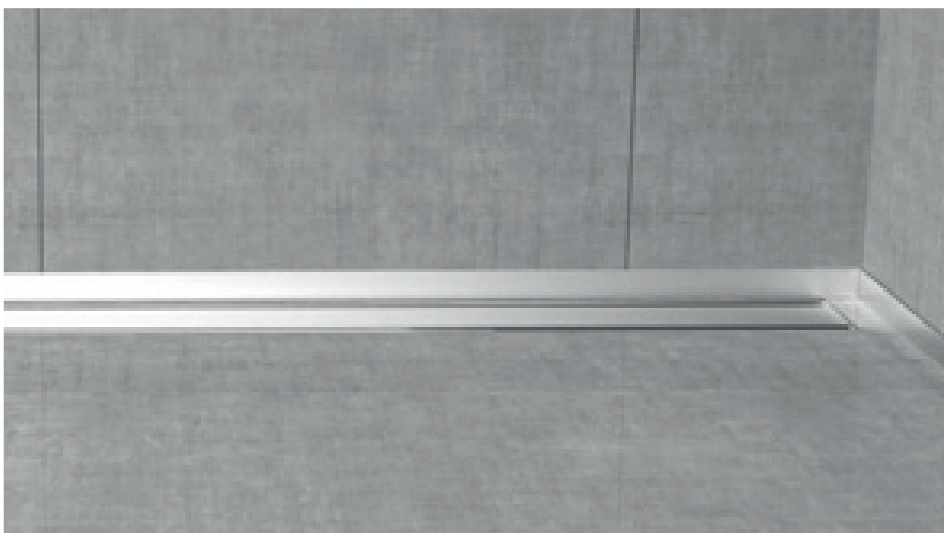

GPS5/ brushed stainless steel AISI 304 DIN 1.4301

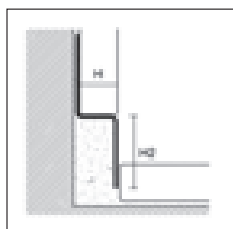







GPS5/



GLASS PROFILE

length = 125 cm - pack 5 pcs

ART.	finishing		H	H2		
STAINLESS STEEL						
			23	33	45	
GPS5/10/	brushed stainless steel AISI 304 DIN 1.4301		10	31551	31553	31559
	euro/pc					
GPS5/11/	brushed stainless steel AISI 304 DIN 1.4301		11	31563	31572	-
	euro/pc					-
GPS5/12/	brushed stainless steel AISI 304 DIN 1.4301		12,5	31555	31557	31561
	euro/pc					
MATT BLACK COLOUR-COATED STAINLESS STEEL						
GPS5/10/	matt black RAL 9005 colour-coated stainless steel AISI 304 DIN 1.4301		10	31567	31568	-
	euro/pc					-
GPS5/11/	matt black RAL 9005 colour-coated stainless steel AISI 304 DIN 1.4301		11	31570	31571	-
	euro/pc					-
GPS5/12/	matt black RAL 9005 colour-coated stainless steel AISI 304 DIN 1.4301		12,5	31573	31574	-
	euro/pc					-

individually packed

GPS5/ is also available in 8 mm height on request, with a minimum order of 30 pcs.

Complete the article code with H2 measure (for example GPS5/10/ for H2 = 23 becomes GPS5/10/23).



GPS5/ matt black RAL 9005 colour-coated stainless steel AISI 304 DIN 1.4301

GU/ and TGU/ are anodised aluminium profiles suitable for the insertion of glass walls on the floor and on the wall of floor-level showers.

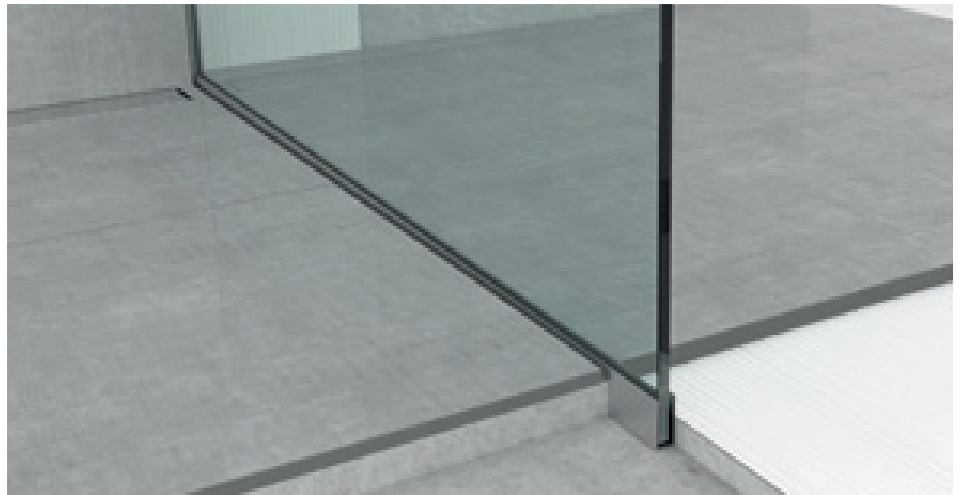

GU/40/12 + TGU/12 silver anodised aluminium

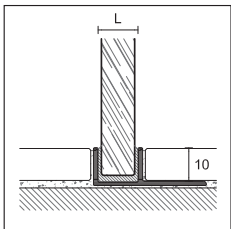

TGU/



GLASS PROFILE

length = 270 cm - pack 10 pcs

ART.	finishing	12	14
ALUMINIUM			
TGU/	silver anodised	67760	67762
<i>euro/m</i>			

individually packed

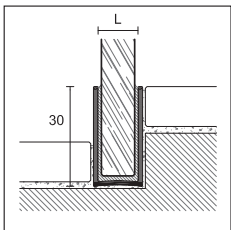

GU/30/

GLASS PROFILE

length = 270 cm - pack 10 pcs

ART.	finishing	12	14
ALUMINIUM			
GU/30/	silver anodised	67770	67772
<i>euro/m</i>			

GU/40/ silver anodised

<i>euro/m</i>			
---------------	--	--	--

individually packed

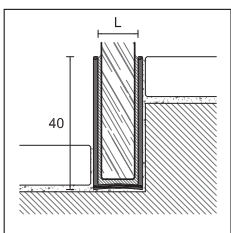

GU/40/

Complete the article code with L measure
(for example GU/30/ per L = 12 becomes
GU/30/12)

sanibord

Sanibord BP/22 and BP/25 are technical profiles in coextruded PVC to be installed between the covering and the bath tub or shower tray during the laying. These profiles allow to avoid the use of silicone and, besides the aesthetic advantages, guarantee a high hygienic level over time.



BP/22



BP/25

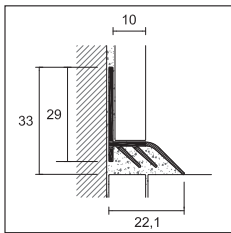

BP/22



SANIBORD

length = 270 cm - pack 20 pcs

ART. finishing

CO-EXTRUDED PVC

BP/22 anti-mould white



95520

euro/m

no partial packaging

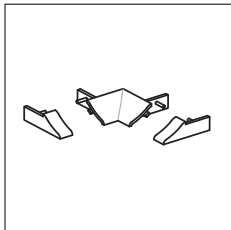

BPT/22

INSIDE CORNER AND RIGHT/LEFT END CAPS FOR BP/22

pack 6 blister

ART. finishing

POLYPROPYLENE

BPT/22 white



95530

euro/blister

no partial packaging

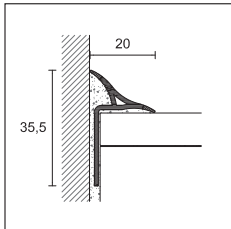

BP/25

SANIBORD

length = 270 cm - pack 20 pcs

ART. finishing

CO-EXTRUDED PVC

BP/25 anti-mould white



95540

euro/m

no partial packaging

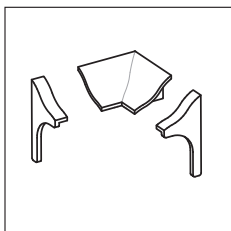

BPT/25

INSIDE CORNER AND RIGHT/LEFT END CAPS FOR BP/25

pack 6 blister

ART. finishing

POLYPROPYLENE

BPT/25 white



95545

euro/blister

no partial packaging

KIT: 1 PC OF 180 CM + 2 PCS OF 90 CM + 2 INSIDE CORNERS AND RIGHT/LEFT END CAPS

pack 10 pcs

ART. finishing

CO-EXTRUDED PVC

BPK/25 anti-mould white



95494

euro/kit

individually packed - no partial packaging

Sanibord BH/20 and BP/20 are technical profiles in colour-coated aluminium and coextruded PVC to be installed between the covering and the bath tub or the shower tray. These profiles allow to avoid the use of silicone and, besides the aesthetic advantages, guarantee a high hygienic level over time.

BH/20 in colour-coated aluminium is provided with the certified antibacterial technology (in compliance with ISO 22196:2011 standards) which allows to reduce the presence of the most dangerous bacteria up to 99%.



BP/20 anti-mould white co-extruded PVC

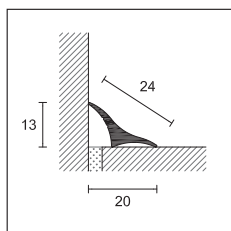

BH/20

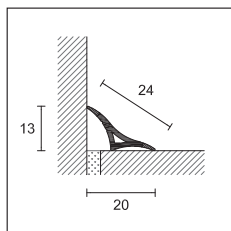

BP/20

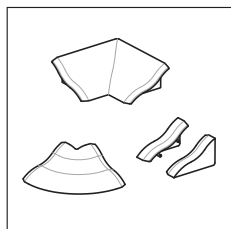

BPT/20

SANIBORD

length = 270 cm - pack 20 pcs

ART. finishing

ANTIBACTERIAL COLOUR-COATED ALUMINIUM

BH/20	colour-coated white antibacterial RAL 9003	<input type="checkbox"/>	95459
<i>euro/m</i>			
BH/20/A adhesive	colour-coated white antibacterial RAL 9003	<input type="checkbox"/>	95460
<i>euro/m</i>			

SANIBORD

length = 270 cm - pack 20 pcs

ART. finishing

CO-EXTRUDED PVC

BP/20	anti-mould white	<input type="checkbox"/>	95490
<i>euro/m</i>			
BP/20/A adhesive	anti-mould white	<input type="checkbox"/>	95470
<i>euro/m</i>			

no partial packaging

INSIDE CORNER, OUTSIDE CORNER, RIGHT/LEFT END CAPS FOR BH/20 AND BP/20

pack 6 blister

ART. finishing

POLYPROPYLENE

BPT/20	white	<input type="checkbox"/>	95480
<i>euro/blister</i>			

no partial packaging

KIT: 1 PC OF 180 CM + 2 PCS OF 90 CM + 2 INSIDE CORNERS AND RIGHT/LEFT END CAPS

pack 10 pcs

ART. finishing

CO-EXTRUDED PVC

BPK/20	anti-mould white	<input type="checkbox"/>	95544
<i>euro/kit</i>			

individually packed excepted BP20 - no partial packaging

ADHESIVE

Cartridges 12 pcs - 300 ml (MS 45) and 290 ml (MS 55)

ART.

MAPEFLEX MS 45	white	<input type="checkbox"/>	6PB010043
MAPEFLEX MS 55	white	<input type="checkbox"/>	6PV010043

For further information, please see Mapei price list.





profiles for floors of same height

The range of profiles is designed to combine different materials with elegance and simplicity. The coupling of different materials thus becomes interior style and not visual limit.

profiles for floors of same height

cerfix® proangle

Proangle is a line of profiles to finish, protect and decorate floors of same level in ceramic, marble, granite, wood or other material. It is also ideal as separation and decoration joint between floors made of different materials, as finishing and protection element for the edges of steps, platforms and worktops and as perimeter profile for the shaping of doormats. Proangle B in natural aluminium is particularly suitable where it is necessary to proceed to polishing, even deep, of marble, resin and wood surfaces.



AI/10 stainless steel AISI 304 DIN 1.4301

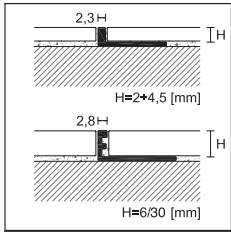

ZG/
ZA/
ZN/
ZK/

PPDESIGN

PROANGLE

length = 270 cm - pack 20 pcs

		H				
ART.	finishing	2	2,5	3	4,5	6
ALUMINIUM						
ZG/	natural aluminium	90207	90206	90208	90210	88159
	euro/m					
ZA/	silver anodised	90336	90337	90338	90340	88204
	euro/m					
BRASS						
ZN/	natural brass	-	-	90078	90080	88024
	euro/m	-	-			
ZK/	chromium plated	-	-	-	90081	88114
	euro/m	-	-	-		

individually packed - ZA/ H 10 and ZG/ H 8 - 10 - 12 are available in length of 90 cm euro/m + art. ZN/22,5 pack 5 pcs

PROANGLE

length = 270 cm - pack 20 pcs

		H			
ART.	finishing	3	4,5	6	8
STAINLESS STEEL					
AI/	stainless steel AISI 304 DIN 1.4301	91636	91638	91642	91644
	euro/m				
AIS/	brushed stainless steel AISI 304 - DIN 1.4301	-	91671	91673	91674
	euro/m	-			
AIX/	stainless steel AISI 316 DIN 1.4404	-	-	91684	91685
	euro/m	-	-		

individually packed - AI/ H 10 is available in length of 90 cm euro/m +

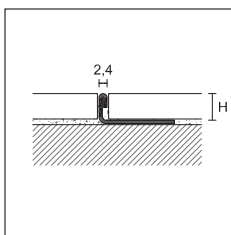

AI/
AIS/
AIX/

Profiles PROANGLE sandblasted stainless steel finish see page 28

Complete the article code with H measure (for example ZG/ for H=10 becomes ZG/10)

Items AIX/ in other heights, on demand for minimum 540 meters for each height



ZG/10 natural aluminium

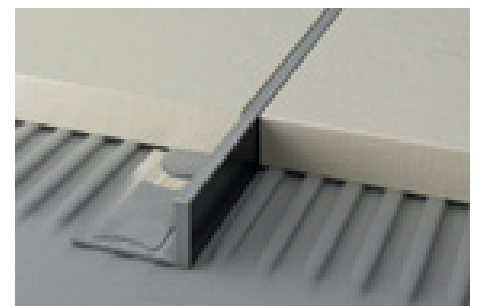

ZBG/10 natural aluminium



ZN/10 natural brass



ZK/10 chromium-plated brass

H												
8	9	10	11	12,5	14	15	17,5	20	22,5	25	27,5	30
88160	88155	88161	88156	88162	88157	88163	88164	88165	88166	88167	-	-
88205	88217	88206	88218	88207	-	88208	88209	88210	88211	88212	-	-
88025	-	88026	88038	88027	-	88028	88029	88030	88031	-	-	-
88115	-	88116	88118	88117	-	-	-	-	-	-	-	-

H												
9	10	11	12,5	14	15	17,5	20	22,5	25	27,5	30	
91645	91646	91647	91648	91649	91650	91652	91654	91656	91658	91660	91662	
-	91675	91677	91676	-	91678	-	91679	-	-	-	-	
-	91686	91688	91687	-	-	-	-	-	-	-	-	

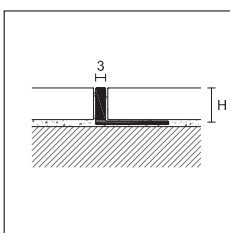

ZBG/



PROANGLE B

length = 270 cm - pack 20 pcs

		H					
ART.	finishing	8	10	12,5	15	20	22,5
ALUMINIUM							
ZBG/	natural aluminium	90010	90012	90014	90016	90018	90020
euro/m							

individually packed

Complete the article code with H measure (for example ZBG/ for H=10 becomes ZBG /10)

proflex line

Proangle is also available in the Flex version, specially studied for those situations where there is the need to curve the profile. Proangle Flex can be curved by hand or through the specific tool Proflex Machine.



AIF/10 stainless steel AISI 304 DIN 14301

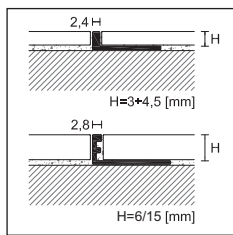

ZGF/
ZNF/

PRO FLEX LINE

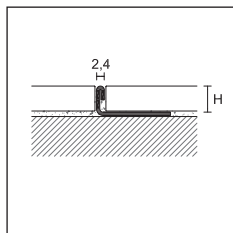

AIF/

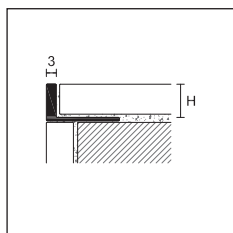

ZBGF/

PRO FLEX LINE

PROANGLE FLEX

length = 270 cm - pack 20 pcs

ART.	finishing	H						
		3	4,5	6	8	10	12,5	15

ALUMINIUM

ZGF/	natural aluminium		88720	88721	88722	88723	88724	88725	88726
	<i>euro/m</i>								

BRASS

ZNF/	natural brass		88701	-	88703	88704	88705	88706	-
	<i>euro/m</i>			-					-

length = 270 cm - pack 10 pcs

STAINLESS STEEL

AIF/	stainless steel AISI 304 DIN 14301		-	-	91622	91623	91624	91625	-
	<i>euro/m</i>		-	-					-

Proangle Flex is available in other heights on request.

PROANGLE FLEX

length = 270 cm - pack 20 pcs

ART.	finishing	H					
		8	10	12,5	15	20	22,5

ALUMINIUM

ZBGF/	natural aluminium		90011	90013	90015	90017	90019	90021
	<i>euro/m</i>							

individually packed

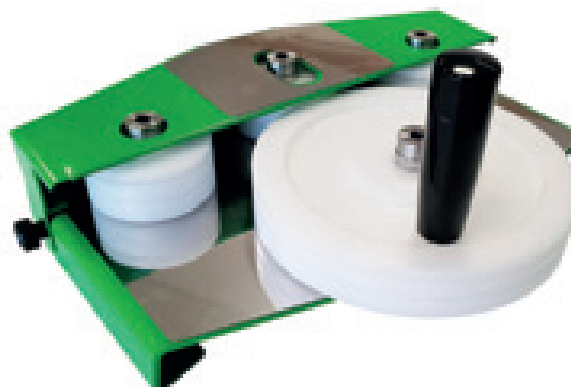

Complete the article code with H measure (for example ZGF/ for H=8 becomes ZGF/8)

PROFLEX MACHINE - hand machine to bend proflex line profiles, see page 250

Prodecor and Prodecor DJ are two lines of profiles for finishing and protecting floors of same level in ceramic, marble, granite, wood or other materials. They are also ideal as separation and decoration joints between floors made of different materials, as perimeter profiles for the shaping of doormats or as protection and finishing of platforms and ceramic steps.

The visible thickness makes the profile an elegant separation element perfectly integrated into the floor.

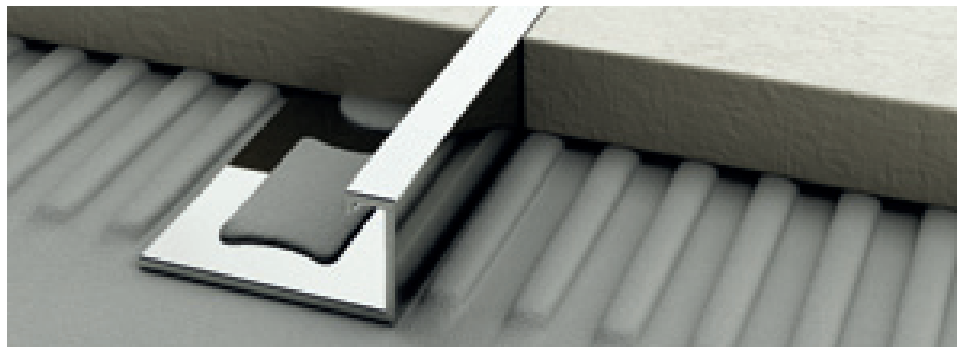

DJK/15 chromium-plated brass

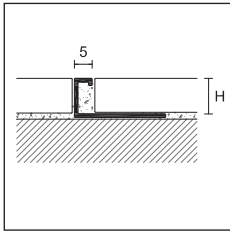

DJG/
DJA/
DJN/
DJK/



PPDESIGN

PRODECOR DJ

length = 270 cm - pack 20 pcs

		H				
ART.	finishing	8	10	12,5	15	20
ALUMINIUM						
DJG/	natural aluminium		95670	95672	95674	-
	<i>euro/m</i>				-	-
DJA/	silver anodised		95680	95682	95684	-
	<i>euro/m</i>				-	-
BRASS						
DJN/	natural brass		95690	95692	95694	95691
	<i>euro/m</i>					95693
CHROMIUM-PLATED BRASS						
DJK/	chromium plated		95700	95702	95704	95703
	<i>euro/m</i>					95705

individually packed - art. DJN/20 and DJK/20 pack 10 pcs

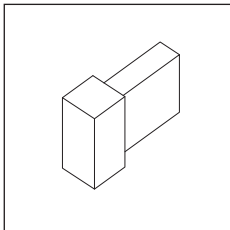

OUTSIDE AND INSIDE CORNERS

pack 5 pcs

		H				
ART.	finishing	8	10	12,5	15	20
ALUMINIUM						
DJG/ /EI	natural aluminium		95676	95677	95678	-
	<i>euro/pc</i>				-	-
DJA/ /EI	silver anodised		95686	95687	95688	-
	<i>euro/pc</i>				-	-
BRASS						
DJN/ /EI	natural brass		95696	95697	95698	95715
	<i>euro/pc</i>					95716
CHROMIUM-PLATED BRASS						
DJK/ /EI	chromium plated		95706	95707	95708	95709
	<i>euro/pc</i>					95710

no partial packaging

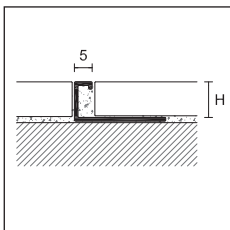

DJAF/
DJNF/



PRO FLEX LINE

PRODECOR DJ FLEX

length = 270 cm - pack 10 pcs

		H				
ART.	finishing	8	10	12,5	15	20
ALUMINIUM						
DJAF/	silver anodised		-	95685	95689	-
	<i>euro/m</i>				-	-
BRASS						
DJNF/	natural brass		-	95695	95699	-
	<i>euro/m</i>				-	-

individually packed

DJAF/ and DJNF/ are available in 8, 15 and 20 mm height on request, with a minimum order of 100 pcs for each code.

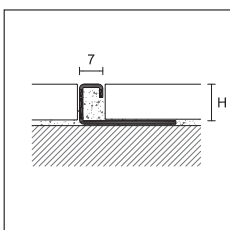

DI/



PRODECOR

length = 270 cm - pack 20 pcs

		H				
ART.	finishing	8	10	12,5	15	20
STAINLESS STEEL						
DI/	polished stainless steel AISI 304 DIN 1.4301		95906	95908	95910	95911
	<i>euro/m</i>					95907

art. DI/20 pack 10 pcs

cerfix® prostyle

Prostyle is a line of multi-purpose profiles for the finishing and decoration of floors of same level in ceramic, marble, granite or other types of materials. It is also ideal as separation and decoration joint between floors of different materials and, in the stainless steel version, it is suitable for the protection of ceramic steps and for the surfaces subject to the passage of heavy and frequent loads.

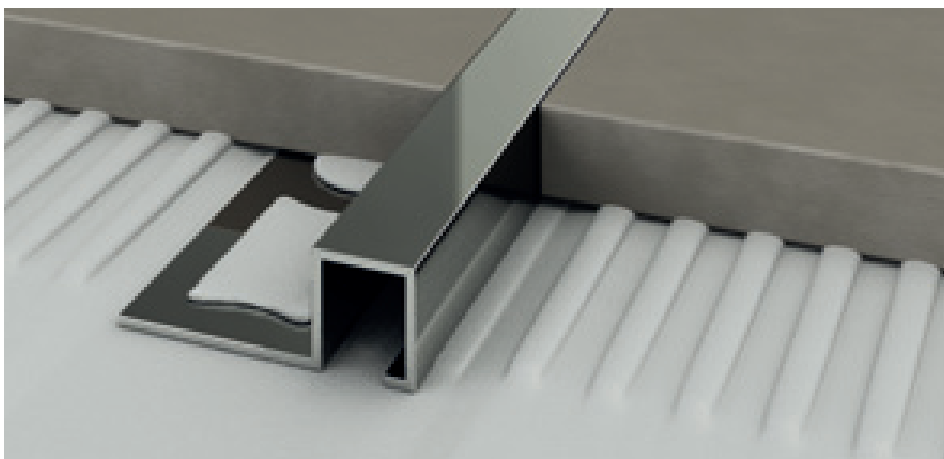

UK/12 chromium-plated brass

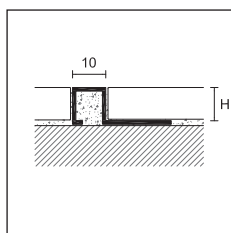

UG/
UA/
UN/
UK/

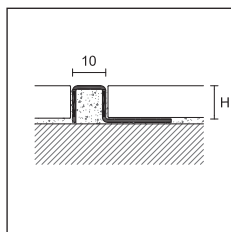

UI/
UIS/

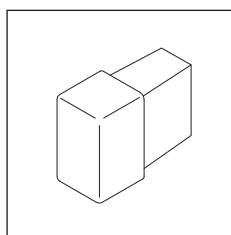

PROSTYLE

length = 270 cm - pack 20 pcs

		H						
ART.	finishing	8	10	11	12,5	15	20	
ALUMINIUM								
UG/	natural aluminium		93368	93370	-	93372	93377	-
	<i>euro/m</i>				-			-
UA/	silver anodised		93378	93380	-	93382	93387	-
	<i>euro/m</i>				-			-

length = 270 cm - pack 10 pcs

STAINLESS STEEL								
UI/	polished stainless steel AISI 304 DIN 1.4301		93400	93401	-	93402	93403	93404
	<i>euro/m</i>				-			
UIS/	brushed stainless steel AISI 304 DIN 1.4301		93348	93350	-	93352	93360	93361
	<i>euro/m</i>				-			
BRASS								
UN/	natural brass		93300	93302	93311	93304	93306	93308
	<i>euro/m</i>							
UK/	chromium plated		93325	93327	93312	93329	93338	93340
	<i>euro/m</i>							

individually packed

OUTSIDE AND INSIDE CORNERS

		H						
ART.	finishing	8	10	11	12,5	15	20	
ALUMINIUM								
UG/ /EI	natural aluminium		93373	93374	-	93375	93376	-
	<i>euro/pc</i>				-			-
UA/ /EI	silver anodised		93383	93384	-	93385	93386	-
	<i>euro/pc</i>				-			-
STAINLESS STEEL								
UI/ /EI	polished stainless steel AISI 304 DIN 1.4301		93405	93406	-	93407	93408	93409
	<i>euro/pc</i>				-			
UIS/ /EI	brushed stainless steel AISI 304 DIN 1.4301		93353	93354	-	93355	93356	93357
	<i>euro/pc</i>				-			
BRASS								
UN/ /EI	natural brass		93301	93303	93341	93305	93307	93309
	<i>euro/pc</i>							
UK/ /EI	chromium plated		93334	93335	93342	93336	93337	93339
	<i>euro/pc</i>							

no partial packaging

Complete the article code with H measure
(for example UG/ for H=8 becomes UG/8)

Projoint U and Projoint they are a range of separation joints in stainless steel and brass, especially suitable in case of transit of high and frequent loads. The version 799 / in case of need can be inserted and polished even after the installation after the cutting of the flooring.

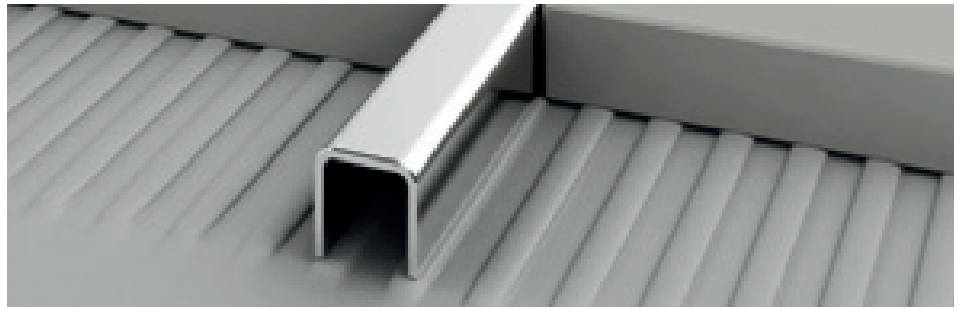

799/U/12 polished stainless steel AISI 304 DIN 1.4301

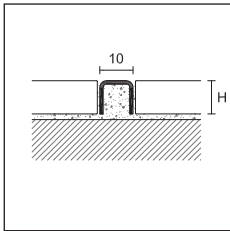

799/U/
399/U



PROJOINT U

length = 270 cm - pack 20 pcs

H	10	12,5
----------	-----------	-------------

ART. finishing

STAINLESS STEEL

799/U/	polished stainless steel AISI 304 DIN 1.4301		75078	75072
	<i>euro/m</i>			

BRASS

399/U	polished brass		75077	-
	<i>euro/m</i>			-

individually packed

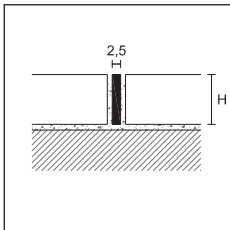

799/



PROJOINT

length = 270 cm - pack 20 pcs

H	10
----------	-----------

ART. finishing

STAINLESS STEEL

799/	stainless steel AISI 304 DIN 1.4301		74966
	<i>euro/m</i>		

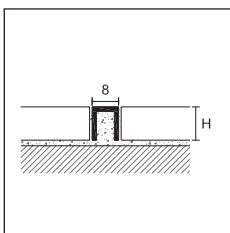

380/8

PROJOINT

length = 270 cm - pack 20 pcs

measures LxH	8x10
---------------------	-------------

ART. finishing

BRASS

380/8	natural brass		75047
	<i>euro/m</i>		

Complete the article code with H measure
(for example 799/U/ for H=10 becomes 799/U/10)

projoint

Projoint T is a line of profiles for the separation, protection and decoration of same-level floors in ceramic, marble, granite, wood or other materials. It is also ideal to cover any imperfections due to the cutting or for the laying of floors made of different materials. Its special section allows to cover slight height differences (2÷3 mm) between two different types of floor. It is also easy to install, thanks to the arrow shape which allows a perfect fixing with sealants or adhesives.



99/T/14 silver anodised aluminium

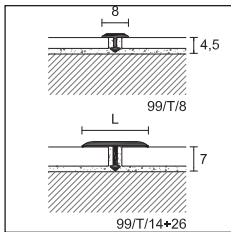

99/T/
399/T/
399/TC/



PROJOINT T

length = 270 cm - pack	50 pcs	50 pcs	30 pcs	20 pcs
width	8	14	20	26

ART. finishing

ALUMINIUM

silver anodised		75075	75080	63600	75082
euro/m					
gold anodised		-	75083	75084	75085
euro/m					
99/T/ titanium anodised		-	75099	-	-
euro/m					
colour-coated anthracite grey RAL 7016		-	75091	-	-
euro/m					

length = 270 cm - pack	-	10 pcs	-	-
width	-	14	-	-

ART. finishing

ALUMINIUM decors ALCROM® PLUS

99/T/ 97 black		-	75095	-	-
euro/m					

individually packed

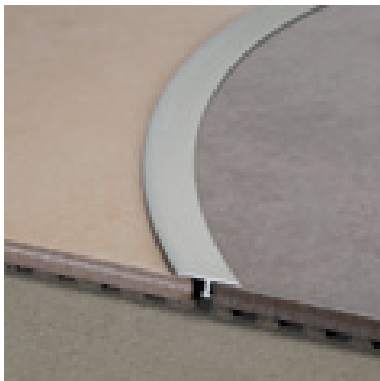

99/T/14 silver anodised aluminium

PROJOINT T

length = 90 cm - pack 10 pcs / blister		L
ART. finishing		14

ALUMINIUM

silver anodised		20008
euro/pc		
499/T/ gold anodised		20010
euro/pc		

PROJOINT T

length = 270 cm - pack 20 pcs	LxH
ART. finishing	26 X 4,5

ALUMINIUM

99/TR/26 silver anodised		75081
euro/m		

individually packed

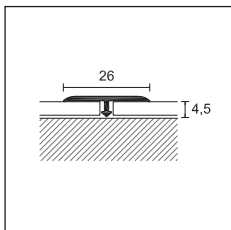

99/TR/26

PRO FLEX LINE

Projoint T 99/T/ can be bent with Proflex Machine (except 99/T/14 97 black).

Complete the article code with L measure (for example 99/T/ for L=14 becomes 99/T/14)

packaging in blister no partial packaging

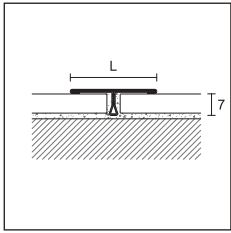

799/T/
799/TS/

PROJOINT T

length = 270 cm - pack	30 pcs	20 pcs
width	14	26

ART. finishing

STAINLESS STEEL

799/T/	polished stainless steel AISI 304 DIN 1.4301		75092	75096
799/TS/	brushed stainless steel AISI 304 DIN 1.4301		75093	75097

individually packed

PROJOINT T

length = 90 cm - pack 10 pcs / blister		L
ART. finishing		14

4799/T	polished stainless steel AISI 304 DIN 1.4301		20001	-
4799/TS	brushed stainless steel AISI 304 DIN 1.4301		20002	-

PROJOINT T

length = 270 cm - pack	50 pcs	20 pcs	20 pcs	20 pcs
width	8	14	20	26

ART. finishing

BRASS

399/T/	polished		75070	75087	75090	75088
	euro/m					
	pack		30 pcs	30 pcs	-	10 pcs
399/TC/	chromium plated		75071	75086	-	75089
	euro/m					

individually packed

PROJOINT T

length = 90 cm - pack 10 pcs / blister		L
ART. finishing		14

4399/T	polished		20016
	euro/pc		

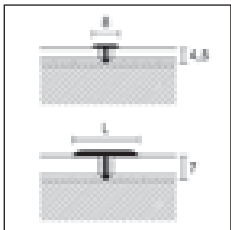

PPDESIGN

399/T/
399/TC/



799/T/26 polished stainless steel AISI 304 DIN 1.4301



399/T/14 polished brass

PRO FLEX LINE

Projoint T 399/T/ and 399/TC/ can be bent with Proflex Machine.

Complete the article code with L measure (for example 799/T/ for L=14 becomes 799/T/14)

projoint

Projoint R is a line of profiles for subdivision and / or decoration of floors of the same level in ceramic, marble, granite, wood or other materials. The thickness of the upper part makes it particularly suitable for the polishing of wood, marble, etc...



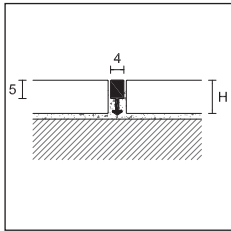

399/R/10 natural brass



99/R/
399/R/



PROJOINT R

length = 270 cm - pack 50 pcs		H	
ART.	finishing	10	14
ALUMINIUM			
99/R/	natural aluminium		75006
	<i>euro/m</i>		75016
length = 270 cm - pack 20 pcs		H	
BRASS			
399/R/	natural brass		75007
	<i>euro/m</i>		75017
length = 90 cm - pack 10 pcs 			
BRASS			
4399/R/10	natural brass		20006
	<i>euro/pc</i>		-

Projoint M is ideal as a separation joint and / or renovation and decoration between floors of the same level laid with glue or mortar. Used between materials of different thickness or type, it could also be polished both in the aluminium and brass version.



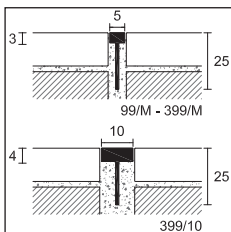

399/M natural brass



99/M
399/M
399/10



PROJOINT M

length = 270 cm - pack		50 pcs	
measures	5x3x25	10x4x25	
ART.	finishing		
ALUMINIUM			
99/M	natural aluminium		75005
	<i>euro/m</i>		-
	pack	20 pcs	10 pcs
BRASS			
399/M	natural brass		74975
	<i>euro/m</i>		-
399/10	natural brass		-
	<i>euro/m</i>		74906

Complete the article code with H measure (for example 99/R/ for H=10 becomes 99/R/10)

 packaging in blister no partial packaging

Proclassic R is a line of profiles specially designed as threshold cover and to hide junctions and possible imperfections due to the cutting or the laying between floors of different materials. The rounded shape allows to compensate a slight height difference 2÷3 mm) between two different types of floor. The fixing is particularly easy thanks to the possibility to use adhesive or screws.

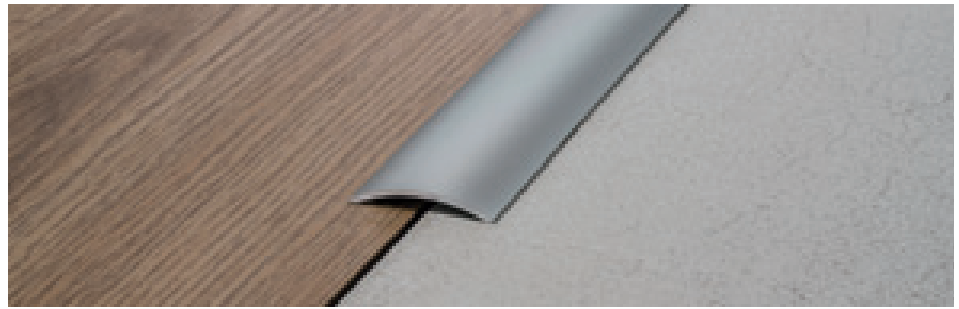

30/A silver anodised aluminium

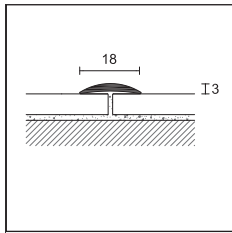

21/

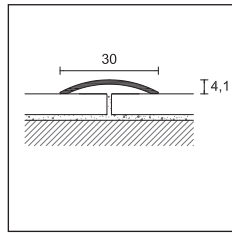

30/



PROCLASSIC R

length = 270 cm - pack 20 pcs

ART.	finishing	A
ALUMINIUM		
21/	silver anodised	71037
	<i>euro/m</i>	
	gold anodised	71047
	<i>euro/m</i>	

individually packed

PROCLASSIC R

pack	30 pcs		10 pcs / blister								
length cm	270		83	93	103	166					
ART.	30/		430/								
finishing	F	A	CV	AD	CV	AD	CV	AD	CV	AD	
ALUMINIUM											
silver anodised		71067	71097	20128	20148	20132	20152	-	20156	20140	20160
gold anodised		71077	71107	-	-	20133	20153	-	20157	-	20161
<i>euro/m</i>											
<i>euro/pc</i>											
titanium anodised		-	71098	-	-	-	-	-	-	-	-
<i>euro/m</i>											
<i>euro/pc</i>											
bronze anodised		-	71117	-	-	-	20154	-	-	-	-
<i>euro/m</i>											
<i>euro/pc</i>											
colour-coated anthracite grey RAL 7016		-	71101	-	-	-	-	-	-	-	-
<i>euro/m</i>											

individually packed

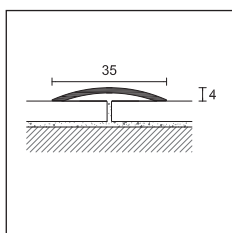

35/

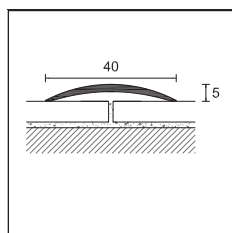

41/

PROCLASSIC R

length = 270 cm - pack 20 pcs

ART.	35/	
finishing	F	A
ALUMINIUM		
silver anodised		71387
<i>euro/m</i>		71417

individually packed

PROCLASSIC R

pack	20 pcs		10 pcs / blister
length cm	270		90
ART.	41/		441/
finishing	F	A	AD
ALUMINIUM			
silver anodised		71587	71617
<i>euro/m</i>			20552
<i>euro/pc</i>			-
gold anodised		-	71627
titanium anodised		-	71618
<i>euro/m</i>			20553
<i>euro/pc</i>			20555
bronze anodised		-	71637
<i>euro/m</i>			-
<i>euro/pc</i>			-

individually packed

Complete the article code with F= drilled, A-A-D=adhesive, CV=with screws (for example 30/ becomes 30/F)

packaging in blister no partial packaging

proclassic

Proclassic R in stainless steel is particularly suitable in public spaces and in the case of passage of frequent and heavy loads. The sparkle of polished stainless steel also matches perfectly the modern floors and furnishings.

Proclassic R in polished brass is classic and modern at the same time and can be easily combined to handles, taps and other furniture accessories of the same material and finish.

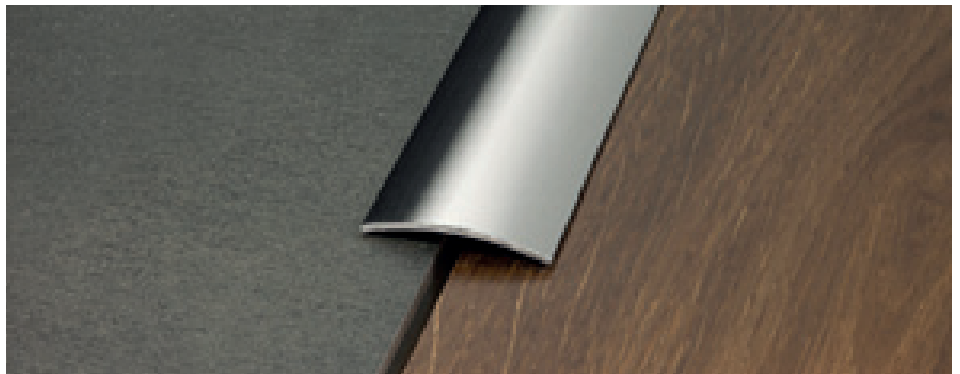

720/A polished stainless steel AISI 430 DIN 1.4016

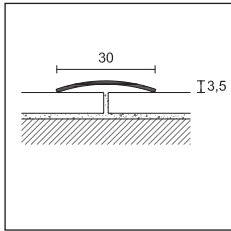

720/
722/
020/

PROCLASSIC R

pack	20 pcs	PRO							
length cm	270	73	83	93	103	166			
ART.	720/	720/							
finishing	F A	F A	F A	F A	F A	F A	F A	F A	
STAINLESS STEEL (thickness 10/10)									
polished stainless steel AISI 430 - DIN 1.4016	71287 71297	71280 71290	71281 71291	71282 71292	-	-	-	71294	
euro/m	-	-	-	-	-	-	-	-	
euro/pc	-	-	-	-	-	-	-	-	

10 pcs / blister									
ART.	4720/								
finishing		CV AD	CV AD	CV AD	CV AD	CV AD	CV AD	CV AD	CV AD
polished stainless steel AISI 430 - DIN 1.4016	- -	20287 20293	20288 20294	20289 20295	20290 20296	20291 20297			
euro/pc	- -	-	-	-	-	-	-	-	
brushed stainless steel AISI 430 - DIN 1.4016	- 71298	- -	- -	- -	- -	- -	- -	- -	
euro/m	-	-	-	-	-	-	-	-	

individually packed

PROCLASSIC R

pack	20 pcs	10 pcs / blister							
length cm	270	73	83	93	103	166			
ART.	722/	4722/							
finishing	- A	CV AD	CV AD	CV AD	CV AD	CV AD	CV AD	CV AD	
STAINLESS STEEL (thickness 10/10)									
brushed stainless steel AISI 304 - DIN 1.4301	- 71268	- -	- -	- 20300	- -	- -	- -	- -	
euro/m	-	-	-	-	-	-	-	-	
euro/pc	-	-	-	-	-	-	-	-	

individually packed

PROCLASSIC R

pack	20 pcs	10 pcs / blister							
length cm	270	73	83	93	103	166			
ART.	020/	4020/							
finishing	F A	CV AD	CV AD	CV AD	CV AD	CV AD	CV AD	CV AD	
BRASS (thickness 10/10)									
polished	71187 71207	20207 20213	20208 20214	20209 20215	20210 20216	20211 20217			
euro/m	-	-	-	-	-	-	-	-	
euro/pc	-	-	-	-	-	-	-	-	

individually packed

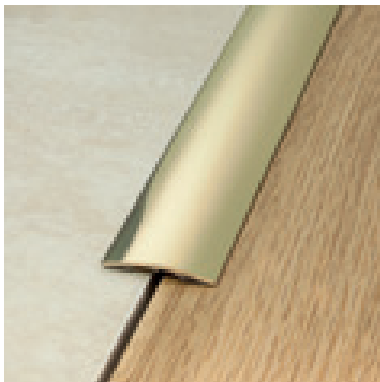

020/A polished brass

Complete the article code with F= drilled, A=adhesive, CV=with screws (for example 720/ drilled becomes 720/F)

packaging in blister no partial packaging

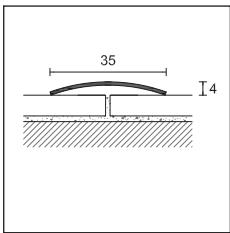

726/



PROCLASSIC R

pack	20 pcs	PRO					
length	270	83	93	166			
ART.	726/	726/					
finishing	F A	F A	F A	F A	F A	F A	

STAINLESS STEEL (thickness 10/10)

polished stainless steel AISI 430 - DIN 1.4016		71507	71517	-	-	71502	71512	-	-
euro/m		-	-	-	-	-	-	-	-
euro/pc		-	-	-	-	-	-	-	-

10 pcs / blister

ART.	4726/						
finishing		CV	AD	CV	AD	CV	AD
polished stainless steel AISI 430 - DIN 1.4016		-	26016	26010	26017	-	26019
euro/pc		-	-	-	-	-	-

brushed stainless steel AISI 430 - DIN 1.4016		-	71518	-	-	-	-
euro/m		-	-	-	-	-	-

individually packed

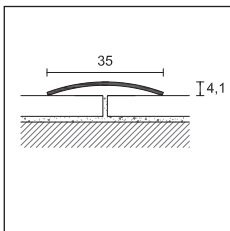

026/

PROCLASSIC R

pack	20 pcs	10 pcs / blister
length cm	270	93
ART.	026/	4026/
finishing	F A	CV AD

BRASS (thickness 10/10)

polished		71447	71457	20409	20415
euro/m		-	-	-	-
euro/pc		-	-	-	-

individually packed

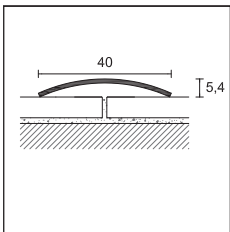

729/

PROCLASSIC R

pack	20 pcs	5 pcs / blister
length	270	93
ART.	729/	4729/
finishing	F A	CV AD

STAINLESS STEEL (thickness 12/10)

polished stainless steel AISI 430 - DIN 1.4016		71667	71677	-	40220
euro/m		-	-	-	-
euro/pc		-	-	-	-
brushed stainless steel AISI 430 - DIN 1.4016		-	71678	-	-
euro/m		-	-	-	-

individually packed



722/A brushed stainless steel AISI 304 DIN 1.4301

Complete the article code with F= drilled, A-A-D=adhesive, CV=with screws (for example 726/ drilled becomes 726/F)

packaging in blister no partial packaging

proclassic

Proclassic F is a line of threshold cover profiles F with a thickness that allows the application under the doors. 19/ and 25/ are provided with a useful non-slip knurled surface. The installation is particularly simple, thanks to the possibility to use adhesive or screws.

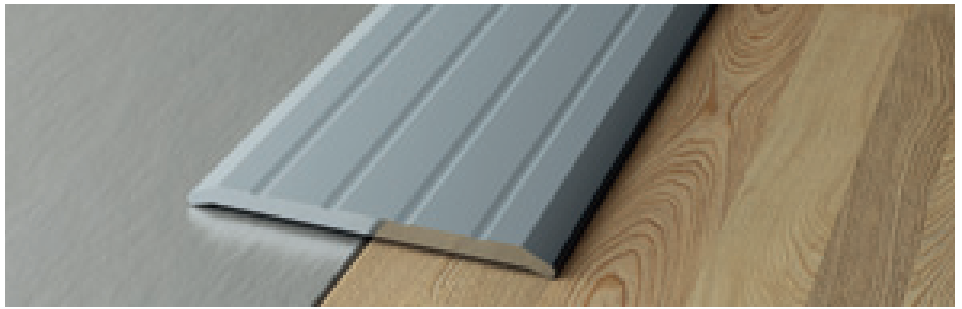

25/A silver anodised aluminium

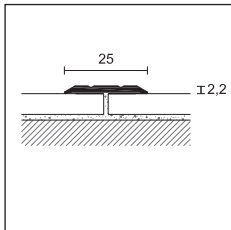

19/



PROCLASSIC F

pack	30 pcs		10 pcs / blister		
length cm	270		93		
ART.	19/		419/		
finishing	F	A	CV	AD	
ALUMINIUM					
silver anodised		71867	71897	27074	27092
euro/m				-	-
euro/pc		-	-		
gold anodised		-	71907	-	27099
euro/m		-	-	-	-
euro/pc		-	-	-	-

individually packed

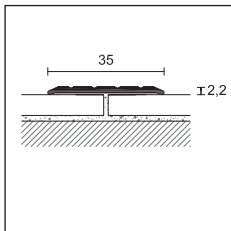

25/

PROCLASSIC F

pack	20 pcs			10 pcs / blister		
length cm	270			93		
ART.	25/			425/		
finishing	F	D	A	CV	AD	
ALUMINIUM						
silver anodised		71947	71948	71977	22533	22553
euro/m					-	-
euro/pc		-	-	-		
gold anodised		71957	-	71987	22534	22554
euro/m		-	-	-	-	-
euro/pc		-	-	-		
bronze anodised		-	-	71997	-	22555
euro/m		-	-	-	-	-
euro/pc		-	-	-	-	-

individually packed

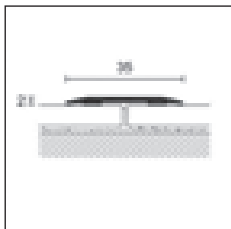

22/A
422/AD

PROCLASSIC F

pack	10 pcs		10 pcs / blister	
length cm	270		90	
ART.	22/A		422/AD	
finishing				
ALUMINIUM				
silver		44000	43790	
euro/m			-	
euro/pc		-		
titanium		44001	43791	
euro/m			-	
euro/pc		-		
ALUMINIUM - decors ALCROM® PLUS				
black 97		43996	-	
euro/m			-	
euro/pc		-	-	

Complete the article code with F=drilled, A/AD=adhesive, CV=with screws (for example 19/ drilled becomes 19/F)

packaging in blister no partial packaging

Wood-effect decors available on page 178 and 179

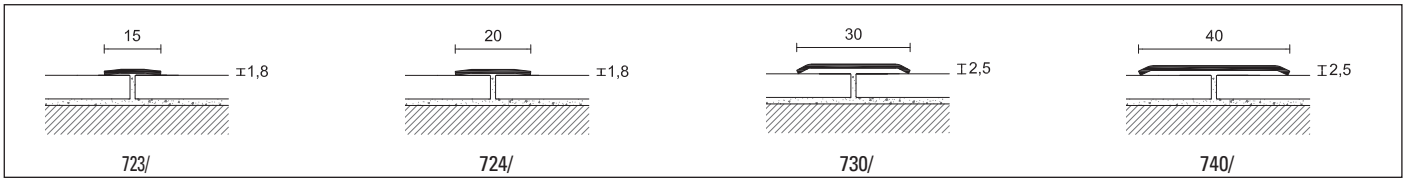

PROCLASSIC F

pack	20 pcs			10 pcs / blister 	10 pcs
length cm	270			90	270
measures LxH	15x1,8	20x1,8	30x2,5	30x2,5	40x2,5 thickness 10/10
ART.	723/A	724/A	730/A	4730/AD	740/A

STAINLESS STEEL

polished stainless steel AISI 430 - DIN 1.4016 	71717	71777	72117	20692	72377
euro/m				-	
euro/pc	-	-	-		-

art. 723/ no individually packed - art. 730/ and 740/ individually packed

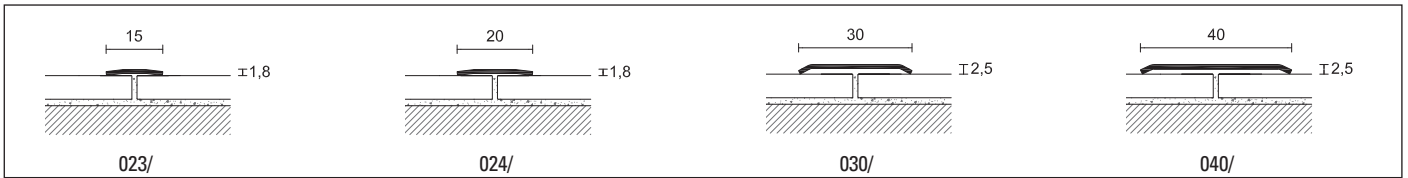

PROCLASSIC F

pack	20 pcs			10 pcs / blister 	10 pcs
thickness 10/10 - length cm	270			90	270
measures LxH	15x1,8	20x1,8	30x2,5	30x2,5	40x2,5
ART.	023/A	024/A	030/A	4030/AD	040/A

BRASS

polished 	71697	71757	72057	20612	72317
euro/m				-	
euro/pc	-	-	-		-

art. 030/ and 040/ individually packed - art. 023/ and 024/ not individually packed



 packaging in blister no partial packaging

22/A aluminium covered with Alcrom® Plus black 97





profiles for floors of different height

The range of profiles for floors of different height is made with a sloping section and allows to connect floors with different thicknesses. Products made of stainless steel, brass or aluminium, are chosen according to the target environment.

cerfix® pronivel

Pronivel NZS / is a line of connection between floors of different level composed by a bearing profile and two connection wings of different size. Together the two pieces allow the elimination of the step between floors of different thickness. The articulated connector permits many combinations and the laying of a new flooring on the side of the connector , even after the application of NZS /.

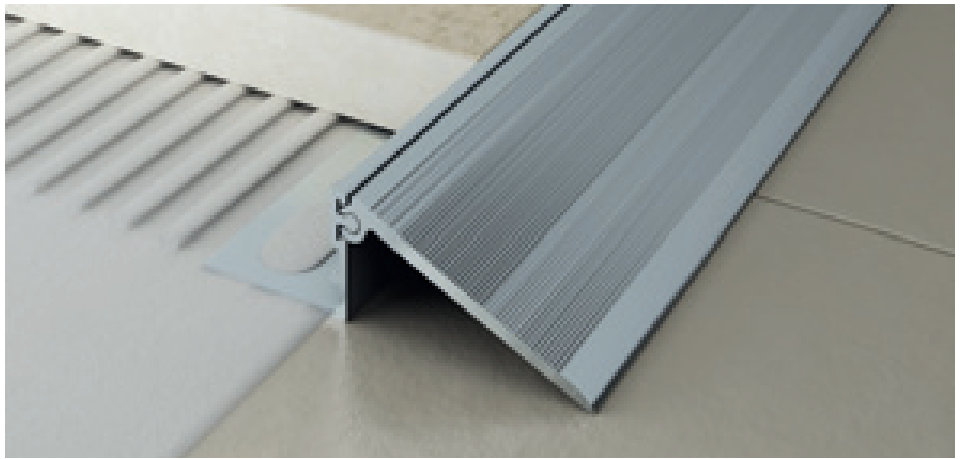

NZS/B/12 + NZS/S2 silver anodised aluminium

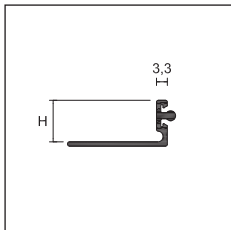

NZS/B/



PRONIVEL N

length = 270 cm - pack 10 pcs

		H			
ART.	finishing	10	12,5	15	20
ALUMINIUM					
NZS/B/	silver anodised	99905	99906	99907	99908
<i>euro/m</i>					
		L			
		38	50		
NZS/S1	connection silver anodised	99900	-		
NZS/S2	connection silver anodised	-	99901		
<i>euro/m</i>					

individually packed

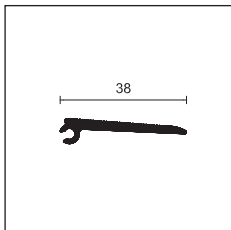

NZS/S1

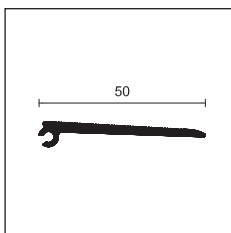

NZS/S2

Complete the article code with H measure (eg. NZS/B/ for H=10 becomes NZS/B/10)

Pronivel P is a line of profiles to be applied during the laying of ceramic or marble flooring and suitable for connect different thicknesses. The versions in stainless steel and brass are suitable to withstand heavy stress.

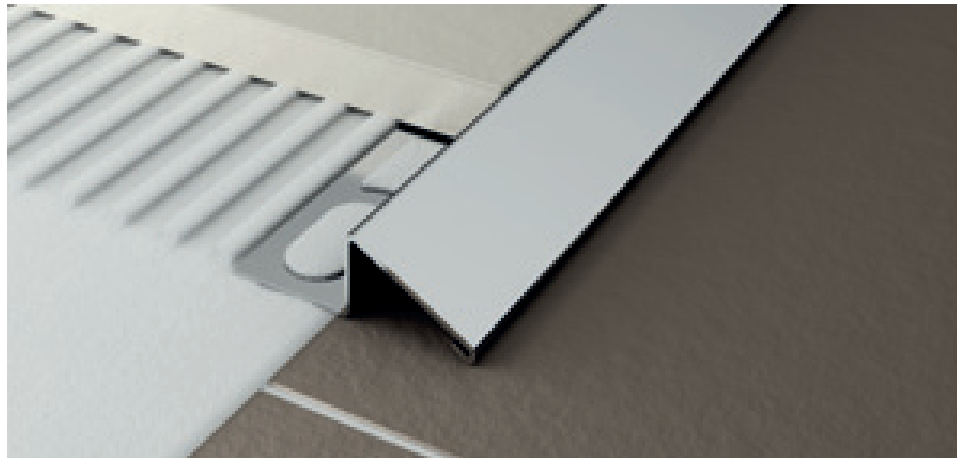

PNI/10 polished stainless steel AISI 304 DIN 1.4301

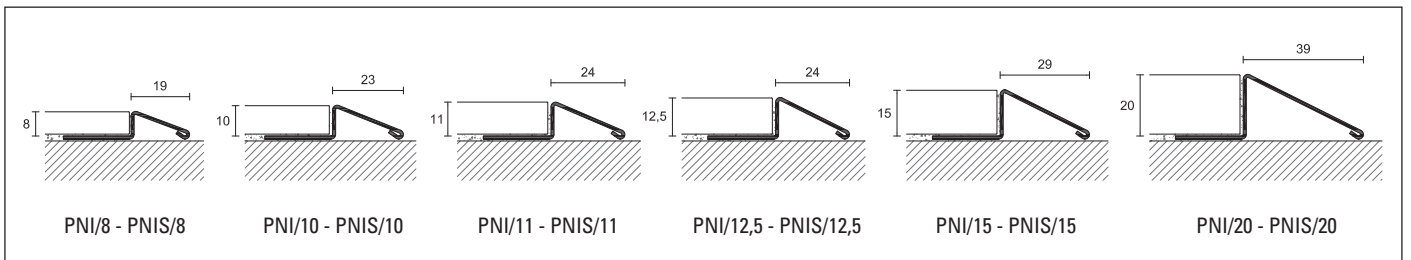
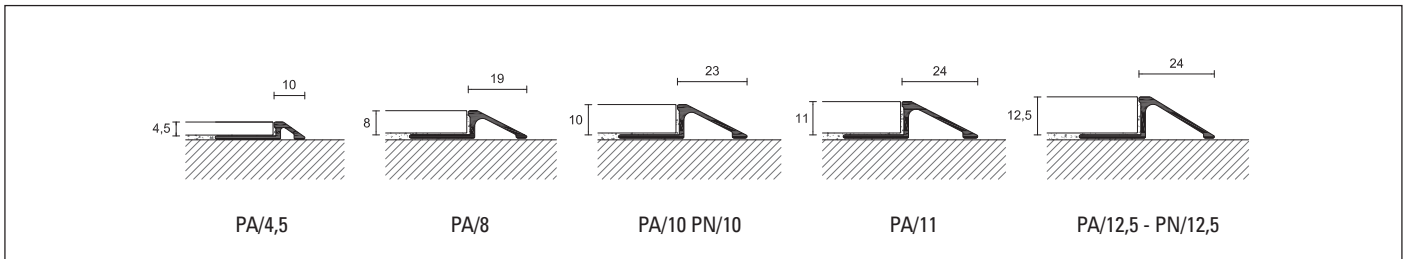

PRONIVEL P

length = 270 cm - pack 10 pcs

		H							
ART.	finishing	4,5	8	10	11	12,5	15	20	
ALUMINIUM									
PA/	silver anodised		93175	93181	93182	93185	93183	-	-
	<i>euro/m</i>							-	-
STAINLESS STEEL									
PNI/	polished stainless steel AISI 304 DIN 1.4301		-	93092	93094	93090	93096	93098	93100
	<i>euro/m</i>		-						
PNIS/	brushed stainless steel AISI 304 DIN 1.4301		-	93093	93095	93091	93097	93099	93101
	<i>euro/m</i>		-						
BRASS									
PN/	natural brass		-	-	93122	-	93123	-	-
	<i>euro/m</i>		-	-		-		-	-

individually packed

Complete the article code with H measure (eg. PA/ for H=8 becomes PA/8)

profiles for floors of different height

cerfix® pronivel

Pronivel L is a profile suitable to connect floors of different heights. Applicable on flooring already laid, it is fixed to the floor with adhesive.



45/SF silver anodised aluminium

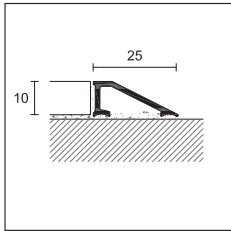

45/



PRONIVEL L

length = 270 cm - pack 20 pcs

ART. finishing

H

10

SF

A

ALUMINIUM

45/ silver anodised



73550

73552

euro/m

individually packed

Pronivel PB is a transition profile between two floors subject to stress. The slight slope makes easier the passing of trolleys or wheelchairs.

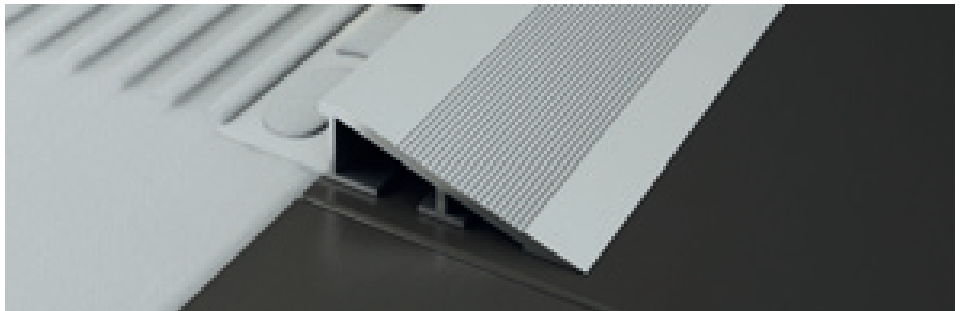

PBA/10 silver anodised aluminium

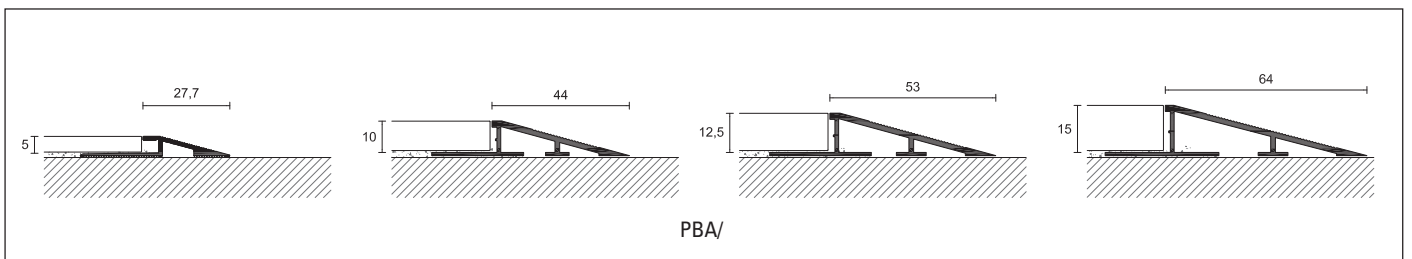

PBA/



PRONIVEL PB

length = 270 cm - pack 10 pcs

ART. finishing

5

10

12,5

15

H

ALUMINIUM

PBA/ silver anodised



93204

93206

93208

93210

euro/m

individually packed

Complete the article code with SF=undrilled, A=adhesive, (eg. 45/ adhesive becomes 45/A)

Complete the article code with H measure (eg. PBA/ for H=10 becomes PBA/10)

Pronivel PL is a line of profiles to be applied during the installation of ceramic or glued wood floors and is suitable for connecting floor coverings of different thicknesses.



PLA/10 silver anodised aluminium

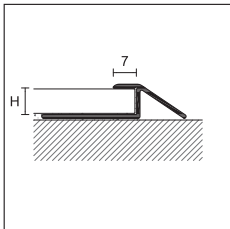

PLA/



NEW PRONIVEL PL

length = 270 cm - pack 10 pcs

		H	
ART.	finishing	8	10
ALUMINIUM			
PLA/	silver anodised	93191	93193
<i>euro/m</i>			

individually packed

Pronivel M is a line of profiles designed to connect during installation floors of different heights. The special section is effective in case of connection with carpet or glue-down or loose-lay LVT.



MIN/10 polished stainless steel AISI 304 DIN 1.4301

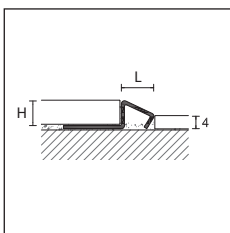

MIN/



PRONIVEL M

length = 270 cm - pack 10 pcs

		H	
ART.	finishing	8	10
STAINLESS STEEL			
MIN/	polished stainless steel AISI 304 DIN 1.4301	93023	93024
<i>euro/m</i>			

individually packed

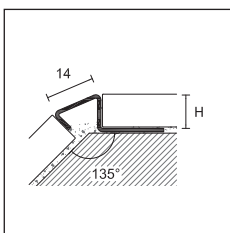

MIN/

Complete the article code with H measure (for example PLA/ for H=8 becomes PLA/8)

Complete the article code with H measure (for example MIN/ for H=10 becomes MIN/10)

prolevel

Prolevel 61/ is a line of profiles to be applied after the installation, and can compensate for differences in height between 6.5 and 13 mm.



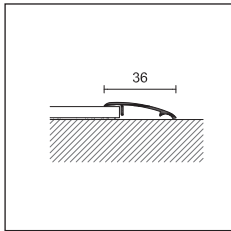

61/A silver anodised aluminium



61/



PROLEVEL HIGH

pack	20 pcs	10 pcs / blister	
length cm	270	90	
ART.	61/	461/	
finishing	A	AD	
ALUMINIUM			
silver anodised	 73437	21200	
euro/m		-	
euro/pc	-		

art. 61/ individually packed

Prolevel High 55/ and 57/ are two profiles in aluminium that allows to remove the small step between two floors with a respective difference in height of 8 and 12 mm. Available also in blister pack and with adhesive, they can be easily used in DIY installations.



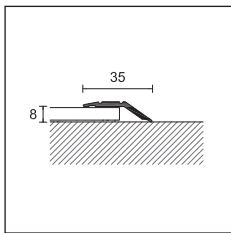

57/A silver anodised aluminium



55/



PROLEVEL HIGH

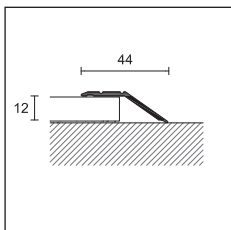

pack	20 pcs	10 pcs / blister	
length cm	270	90	
ART.	55/	455/	
finishing	F	A	CV AD
ALUMINIUM			
silver anodised	 73907	73937	42312 42330
gold anodised	 -	73947	- 42336
euro/m			- -
euro/pc	-	-	

art. 55/ individually packed



57/

PROLEVEL HIGH

pack	20 pcs	10 pcs / blister	
length cm	270	90	
ART.	57/	457/	
finishing	F	A	CV AD
ALUMINIUM			
silver anodised	 73967	73997	42352 42370
gold anodised	 -	74007	- 42376
euro/m			- -
euro/pc	-	-	

art. 57/ individually packed

Complete the item code with F=drilled, A-AD=adhesive, CV=screws (eg. 61/ adhesive becomes 61/A)

 packaging in blister no partial packaging

Prolevel 711/ and 311/ are a line of self-adhesive stainless steel and polished brass profiles which allows the elimination of the step between floors with 7 or 12 mm slope. Available also in blister pack and self-adhesive, they are easily applicable in DIY field.

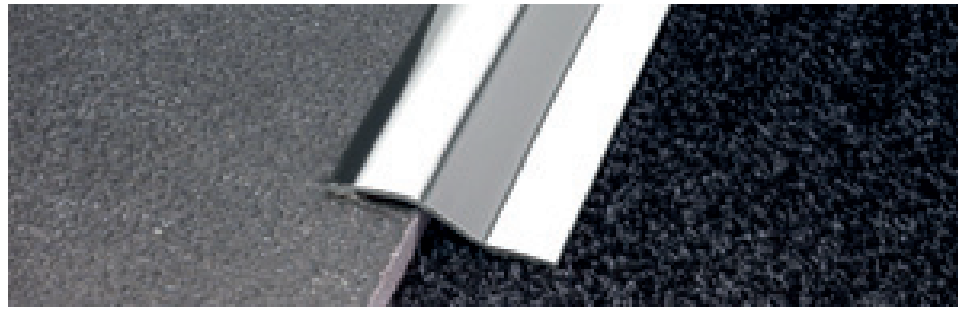



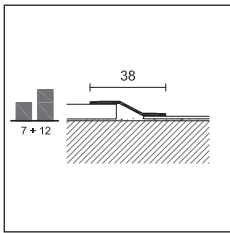

711/A polished stainless steel AISI 430 - DIN 1.4016



711/
311/



PROLEVEL HIGH

pack	20 pcs	10 pcs / blister 	
length cm	270	83	93
ART.	711/	4711/	
finishing	A	AD	AD
STAINLESS STEEL			
polished stainless steel AISI 430 - DIN 1.4016	 73627	40431	40432
euro/m	-	-	-
euro/pc	-	-	-
brushed stainless steel AISI 430 - DIN 1.4016	 73628	-	-
euro/m	-	-	-
ART.	311/	4311/	
finishing	A	AD	AD
BRASS			
polished	 73607	-	22656
euro/m	-	-	-
euro/pc	-	-	-

art. 711/ and 311/ individually packed

Prolevel 712/ and 312/ are a line of self-adhesive stainless steel and polished brass profiles which allows the elimination of the step between floors with 12 or 16 mm slope. Available also in blister pack and self-adhesive, they are easily applicable in DIY field.



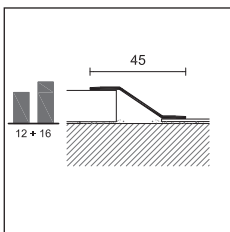

312/A polished brass



712/
312/



PROLEVEL HIGH

pack	10 pcs	5 pcs / blister 	
length cm	270	90	
ART.	712/	4712/	
finishing	A	AD	
STAINLESS STEEL			
polished stainless steel AISI 430 - DIN 1.4016	 73637	40898	
euro/m	-	-	
euro/pc	-	-	
ART.	312/	4312/	
finishing	A	AD	
BRASS			
polished	 73617	40868	
euro/m	-	-	
euro/pc	-	-	

art. 712/ e 312/ individually packed

Complete the item code with A - AD=adhesive (eg. 711/ adhesive becomes 711/A) -  packaging in blister no partial packaging

prolevel

Prolevel High 732/ is a line of profiles for the protection of the perimetral border of floors. Available in stainless steel, it can be also used as stair nosing.



732/SF/10 polished stainless steel AISI 430 DIN 1.4016

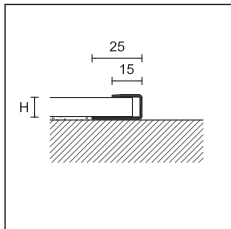

732/SF/



PROLEVEL HIGH

length = 270 cm - pack 15 pcs

ART.	finishing		H
		10	12,5
STAINLESS STEEL			
732/SF/	polished stainless steel AISI 430 DIN 1.4016		74217
	euro/m		74227

individually packed

Prolevel 700/, 300/ and 10/ are a line of transition profiles for floors of small thickness already laid. Available in different widths and also in blister pack, self-adhesive and with screws, they are easily applicable in DIY field.



700/A polished stainless steel AISI 430 DIN 1.4016

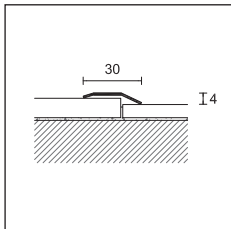

700/
300/



PROLEVEL MEDIUM

pack	20 pcs		10 pcs / blister
length cm	270	270	93
ART.	700/	701/	4701/
finishing	A	F A	AD
STAINLESS STEEL			
polished stainless steel AISI 430 DIN 1.4016		72877	- 72957
euro/m		-	-
euro/pc	-	-	-

art. 700/ and 701/ individually packed

PROLEVEL MEDIUM

pack	20 pcs	10 pcs / blister
length cm	270	93
ART.	300/	4300/
finishing	A	AD
BRASS		
polished		72857
euro/m		21035
euro/pc	-	-

art. 300/ individually packed

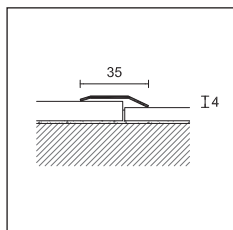

701/

Complete the article code with F=drilled, A-AD=adhesive, CV=screws (eg. 700/ drilled becomes 700/F)

 packaging in blister no partial packaging

Prolevel 6/ is a line of transition profiles in aluminium, for floors of small thickness already laid. Available also in blister pack, self-adhesive and with screws, they are easily applicable in DIY field.

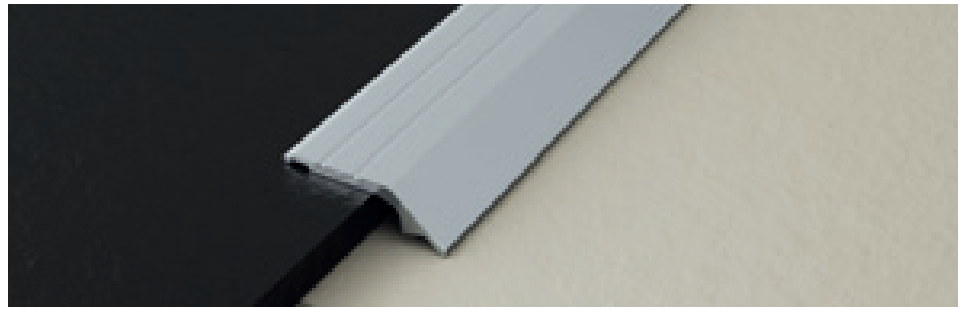



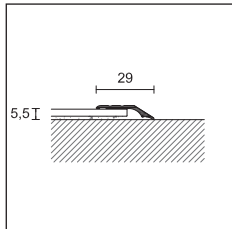

6/A silver anodised aluminium



6/



PROLEVEL MEDIUM

pack	30 pcs		10 pcs / blister 			
length cm	270		93	166		
ART.	6/		46/			
finishing	F	A	CV	AD	CV	AD
ALUMINIUM						
silver anodised		72727 72757	20932	20952	20940	20960
gold anodised		72737 72767	20933	20953	-	-
euro/m			-	-	-	-
euro/pc			-	-	-	-
bronze anodised		- 72777	-	-	-	-
euro/m			-	-	-	-

art. 6/ individually packed

Prolevel Medium 10/ and Prolevel Thin 54/ are two profiles for the connection of PVC floors. They can be installed on already-laid floors and they also acts as protection of the floor edge.



54/A gold anodised aluminium

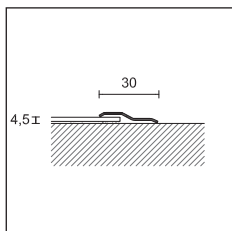

10/



PROLEVEL MEDIUM

pack	20 pcs	
length cm	270	
ART.	10/	
finishing	A	
ALUMINIUM		
silver anodised		72527
euro/m		

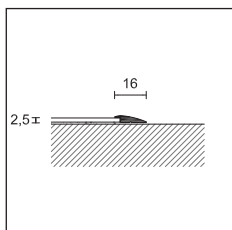

individually packed



54/



PROLEVEL THIN

length = 270 cm - pack 20 pcs			
ART.	finishing	SF	A
ALUMINIUM			
54/	silver anodised		72587 72617
	gold anodised		- 72627
	euro/m		

individually packed

Complete the item code with SF=undrilled, A-AD=adhesive, (eg. 54/ undrilled becomes 54/SF)

 packaging in blister no partial packaging





movement joints

A line designed to permit the expansion and contraction that materials undergo as a result of the seasonal temperature. A wide range of finishes to suit different stresses to which the coating is subjected.

Projoint DIL NE is an expansion joint in co-extruded PVC. Suitable for the laying with glue, it is available in three colors and four heights and it is suitable for large areas with pedestrian traffic. Set on the joints created on the screed, it allows to absorb stresses of compression and expansion.

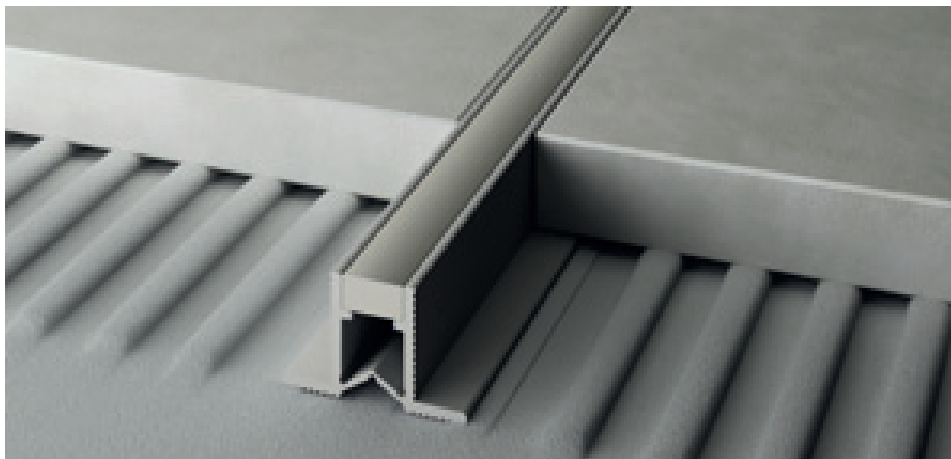

NE/10 co-extruded PVC grey + grey RAL 7035

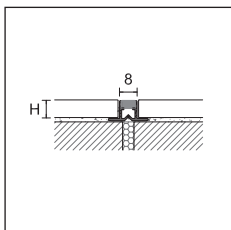

NE/



PROJOINT DIL

length = 270 cm

ART.	finishing	8	10	12,5	15
------	-----------	---	----	------	----

CO-EXTRUDED PVC

	grey+grey RAL 7035		99650	99660	99670	99680
NE/	stone grey+ stone grey RAL 7030		99653	99663	99673	99683
	cream white+cream white RAL 9001		99652	99662	-	-

pack 20 pcs
euro/m

pack 100 pcs
euro/m

no partial packaging

Projoint DIL NJ/ is an expansion joint in co-extruded PVC with perforated side flanges. Suitable for floors laid with glue, it is able to absorb tensile and compression stresses, thanks to the elastic central part. Made of PVC non-toxic and anti shock, UV resistant and it can be used indoors and outdoors.

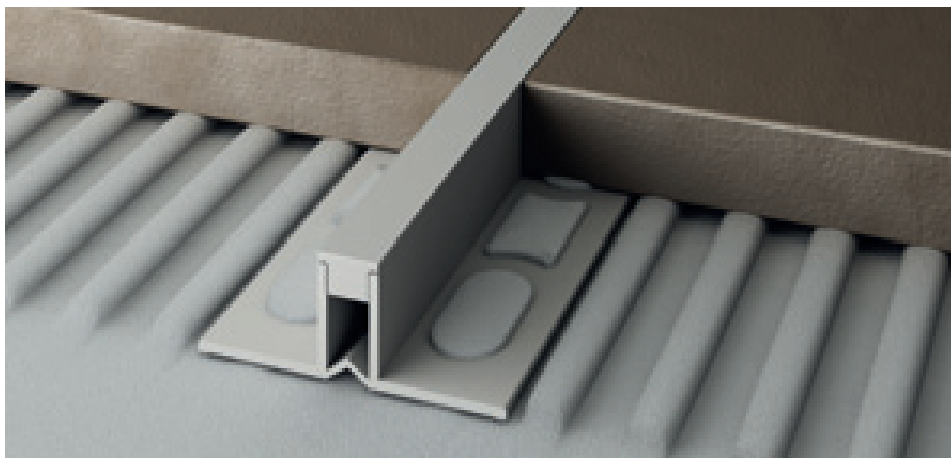

NJ/10 co-extruded PVC light grey RAL 7035

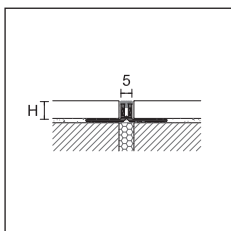

NJ/



PROJOINT DIL

length = 270 cm - pack 20 pcs

ART.	finishing	4,5	8	10	12,5	15
------	-----------	-----	---	----	------	----

CO-EXTRUDED PVC

	light grey RAL 7035		99757	99750	99760	99770	99780
NJ/	stone grey RAL 7030		99758	99752	99762	99772	99782

euro/m

no partial packaging

Complete the article code with H measure (for example NE/ for H=8 becomes NE/8)

Projoint DIL NL/ is an expansion joint in co-extruded PVC with perforated side flanges. Suitable for floors or marble laid with glue, it is able to absorb tensile and compression stresses thanks to the elastic central part. It is suitable for both pedestrian traffic and light driveway (car and transpallet). Made of PVC non-toxic and anti shock, UV resistant and it can be used indoors and outdoors.



NL/10 co-extruded PVC grey + grey RAL 7035

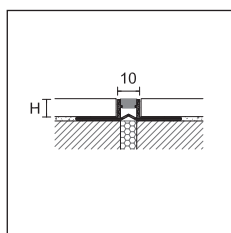

NL/



PROJOINT DIL

length = 270 cm - pack 20 pcs

		H					
ART.	finishing	8	10	12,5	15	20	
CO-EXTRUDED PVC							
NL/	grey+grey RAL 7035		99700	99710	99720	-	-
	stone grey+ stone grey RAL 7030		99704	99714	99724	99734	99744
	black+black RAL 9005		99703	99713	99723	-	-

euro/m

no partial packaging

Projoint DIL NF is an expansion joint in co-extruded PVC for the laying with mortar. Available in three colors and three heights, it is suitable to divide large areas with pedestrian traffic. It allows to absorb compressive and expansion stresses.



NF/45 co-extruded PVC grey + grey RAL 7035

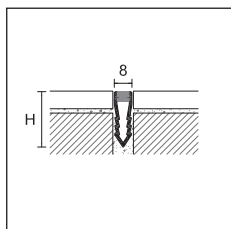

NF/



PROJOINT DIL

length = 270 cm

		H			
ART.	finishing	25	35	45	
CO-EXTRUDED PVC					
NF/	grey+grey RAL 7035		99800	99810	99820
	stone grey+ stone grey RAL 7030		99803	99813	99823
	cream white+cream white RAL 9001		99802	99812	-

pack 20 pcs

euro/m

pack 40 pcs

euro/m

pack 50 pcs

euro/m

pack 80 pcs

euro/m

no partial packaging

Complete the article code with H measure (for example NL/ for H=10 becomes NL/10)

cerfix® projoint

Projoint DIL NAN is an expansion joint in aluminium, with an interchangeable insert in elastic vinyl resin, characterized by a visible section of 15 mm. The structure of the joint allows to protect the edge of the tile and is able to withstand high traffic, both pedestrian and vehicular.

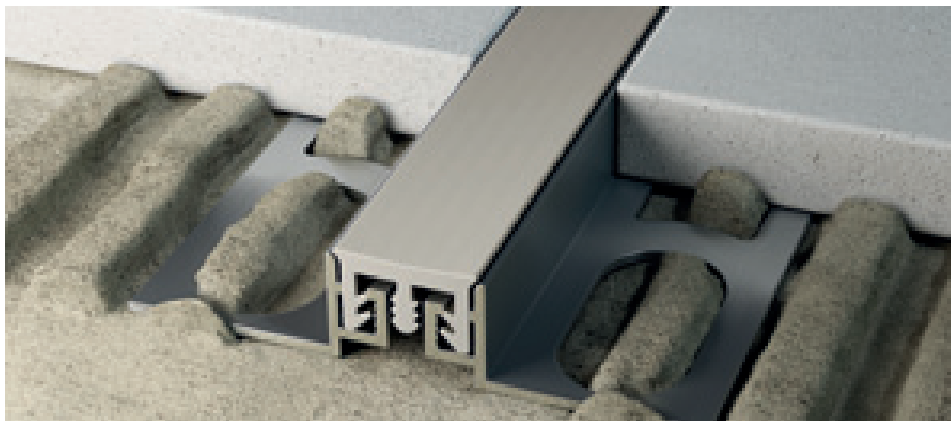

NAN/10 natural aluminium + stone grey rubber

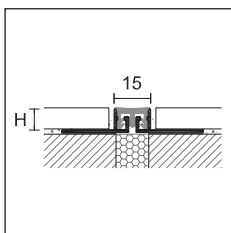

NAN/



PROJOINT DIL

length = 270 cm - pack 10 pcs

ART.	finishing	10	12,5	15
------	-----------	----	------	----

ALUMINIUM

NAN/	natural aluminium + grey RAL 7035 rubber		99974	99975	99976
	natural aluminium + stone grey RAL 7030 rubber		99977	99978	99979

euro/m

individually packed - NAN/ available with black rubber upon request, minimum order 100 pcs

SPARE INSERT FOR NAN/

length= 270 cm - pack 20 pcs

ART.	finishing		
------	-----------	--	--

GM/	grey RAL 7035		99993
	stone grey RAL 7030		99989

euro/m

Projoint DIL NPAN/ is an expansion joint in aluminium, with an interchangeable insert in elastic vinyl resin, characterized by a visible section of 21 mm. The structure of the joint allows to protect the edge of the tile and is able to withstand high traffic, both pedestrian and vehicular.



NPAN/10 natural aluminium + stone grey rubber

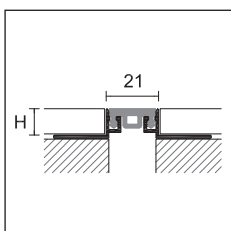

NPAN/



PROJOINT DIL

length = 270 cm - pack 10 pcs

ART.	finishing	10	12,5	15
------	-----------	----	------	----

ALUMINIUM

NPAN/	natural aluminium + stone grey RAL 7030 rubber		99984	99985	99986
-------	--	--	-------	-------	-------

euro/m

individually packed - NPAN/ available with black rubber upon request, minimum order 100 pcs

SPARE INSERT FOR NPAN/

length= 270 cm - pack 20 pcs

ART.	finishing		
------	-----------	--	--

GMP/	stone grey RAL 7030		99988
------	---------------------	--	-------

euro/m

Complete the article code with H measure (for example NAN/ for H=10 becomes NAN/10)

Projoint DIL NIN/ is an expansion joint in stainless steel, with an interchangeable insert in elastic vinyl resin, characterized by a reduced section of 15 mm. The structure of the joint allows to protect the edge of the tile and is able to withstand heavy traffic, both pedestrian and vehicular (forklifts, transpallets and cars).

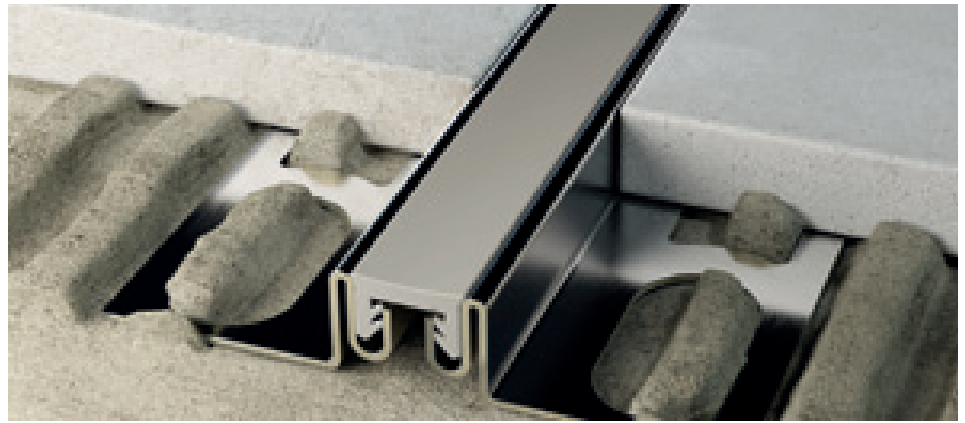

NIN/10 stainless steel + stone grey rubber

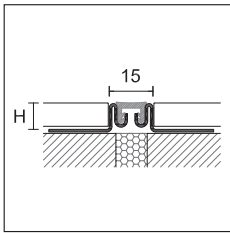

NIN/



PROJOINT DIL

length = 270 cm - pack 5 pcs

		H			
ART.	finishing	10	12,5	15	20

STAINLESS STEEL

NIN/	stainless steel AISI 304 DIN 1.4301 + grey RAL 7035 rubber		99915	99916	99917	99918
	stainless steel AISI 304 DIN 1.4301 + stone grey RAL 7030 rubber		99925	99926	99927	99928
euro/m						

individually packed - NIN/ available with black rubber upon request, minimum order 100 pcs

SPARE INSERT FOR NIN/

length= 270 cm - pack 20 pcs

ART.	finishing				
------	-----------	--	--	--	--

GM/10	grey RAL 7035		99998		
	stone grey RAL 7030		99999		
euro/m					

Projoint DIL NIL/ is a perimeter expansion joint in stainless steel, with an interchangeable insert in elastic vinyl resin, characterized by a visible section of 14 mm. The structure of the joint allows to connect the floor to the wall and is able to withstand heavy traffic, both pedestrian and vehicular (forklifts, transpallets and cars).



NIL/10 stainless steel + stone grey rubber

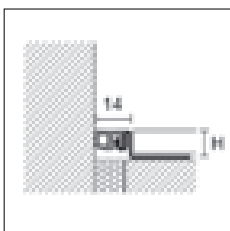

NIL/



PROJOINT DIL

length = 270 cm - pack 5 pcs

		H			
ART.	finishing	10	12,5	15	20

STAINLESS STEEL

NIL/	stainless steel AISI 304 DIN 1.4301 + stone grey RAL 7030 rubber		99896	99897	99898	99899
	euro/m					

individually packed - NIL/ available with black rubber upon request, minimum order 100 pcs

SPARE INSERT FOR NIL/

length= 270 cm - pack 20 pcs

ART.	finishing				
------	-----------	--	--	--	--

GM12/L	stone grey RAL 7030		99987		
euro/m					

Complete the article code with H measure (for example NIN/ for H=10 becomes NIN/10)

Projoint NTA/, NTI/ and NTO/ are expansion joints for the laying with glue with inner section in vulcanized EPDM. The metal structure easily stands up to the recurring pedestrian and vehicular traffic (forklift trucks, transpallets and cars).



NTA/10 natural aluminium + EPDM grey polishable RAL 7046

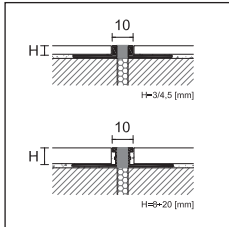

NTA/
NTO/

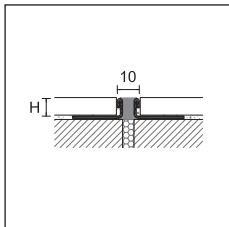

NTI/

PROJOINT DIL

length = 270 cm - pack 10 pcs

ART.	finishing	3	4,5	8	H			10	12,5	15	20
ALUMINIUM											
	natural aluminium + EPDM grey polishable RAL 7046	99421	99425	99441	99445	99449	99453	99457			
	natural aluminium + EPDM black polishable RAL 9005	99422	99426	99442	99444	99450	99454	99458			
NTA/ euro/m											
	natural aluminium + EPDM bahama polishable RAL 10070	99427	99428	-	-	-	-	-	-	-	-
	natural aluminium + EPDM brown polishable RAL 10071	99429	99430	-	-	-	-	-	-	-	-
euro/m											
STAINLESS STEEL											
	stainless steel AISI 304 DIN 1.4301 + EPDM grey RAL 7046	99471	99475	99481	99485	99489	99493	99497			
	stainless steel AISI 304 DIN 1.4301 + EPDM black RAL 9005	99472	99474	99482	99486	99490	-	-			
NTI/ euro/m											
	stainless steel AISI 304 DIN 1.4301 + EPDM bahama RAL 10070	99431	99432	-	-	-	-	-	-	-	-
	stainless steel AISI 304 DIN 1.4301 + EPDM brown RAL 10071	99433	99434	-	-	-	-	-	-	-	-
euro/m											
STAINLESS STEEL											
NTO/	brass natural + EPDM grey polishable RAL 7046	-	-	99401	99405	99409	99413	99417			
	euro/m	-	-								

art. NTO/15 and NTO/20 pack 5 pcs

Projoint STA/ and STI/ are expansion joints for the division of floors laid with mortar, with inner section in vulcanized EPDM. The metal structure easily withstands the recurring pedestrian and vehicular traffic (forklift trucks, transpallets and cars), making them particularly suitable for shopping malls and frequent passage of loads. We suggest the use of the stainless steel hooks ST/7 for the installation.



STI/40 stainless steel AISI 304 DIN 1.4301 + EPDM grey polishable RAL 7046

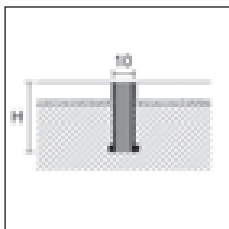

STA/
STI/

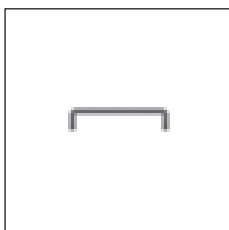

ST/7

PROJOINT DIL

length = 250 cm - pack 10 pcs

ART.	finishing	30	H		40	50
ALUMINIUM						
STA/	natural aluminium + EPDM grey polishable RAL 7046	99581			99585	99589
STAINLESS STEEL						
STI/	stainless steel AISI 304 DIN 1.4301 + EPDM grey polishable RAL 7046	99621			99625	99629
euro/m						

Upon request, we can make different measures and colours for articles STA/ and STI/. Please contact our sales department

ACCESSORIES

pack 100 pcs

ART.	finishing	
STAINLESS STEEL		
ST/7	steel hook for STA/ and STI/ profiles	99640
euro/pc (euro/pack)		

no partial packaging

Projoint NZA is an expansion joint in aluminium consisting of two interlocking and sliding profiles. Suitable for ceramic floors subjected to intense traffic, it ensures a high resistance to loads and high traffic both pedestrian and vehicular (forklifts, transpallet and cars).



NZA/10 natural aluminium

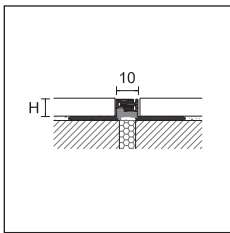

NZA/



PROJOINT DIL

length = 270 cm - pack 20 pcs

		H				
ART.	finishing	3	5	8	10	12,5
ALUMINIUM						
NZA/	natural aluminium	-	-	99910	99912	99914
	euro/m	-	-			
NZA/	silver anodised	99300	99320	-	-	-
	euro/m			-	-	-

individually packed

Projoint NZS is an expansion joint in aluminium with high absorption. Thanks to the 2 interlocking parts, the joint can absorb movements of +/- 5 mm with articulated flins that permit tridimensional movements. The structure of the joint protects the edge of the tile, and it bears the pedestrian and vehicular passage. NZS is also available as a joint cover (when tiles are already laid), NZS/A, or side joint for industrial buildings, NZS/L.



NZS/10 silver anodised aluminium



NZS/A/40 silver anodised aluminium

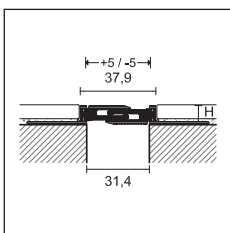

NZS/



PROJOINT DIL

length = 270 cm - pack 5 pcs

		H			
ART.	finishing	10	12,5	15	20
ALUMINIUM					
NZS/	silver anodised	99880	99881	99882	99883
	euro/m				

PROJOINT DIL

length = 270 cm - pack 5 pcs

		H
ART.	finishing	8
ALUMINIUM		
NZS/A/40	silver anodised	99885
	euro/m	

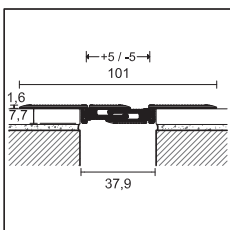

NZS/A/40

PROJOINT DIL

length = 270 cm - pack 5 pcs

		H			
ART.	finishing	10	12,5	15	20
ALUMINIUM					
NZS/L/	silver anodised	99890	99891	99892	99893
	euro/m				

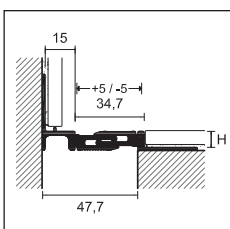

NZS/L/

Complete the article code with H measure (for example NZA/ for H=8 becomes NZA/8)

cerfix® projoint

Projoint DIL PBE is a structural joint composed of two L-shaped profiles in natural aluminium and an expanding part in interchangeable plasticized PVC, available in black or grey. The two L-shaped profiles have drilled bases to allow the mechanical fixing with screws to the underlying structure.



PBE/30 natural aluminium + striated black rubber

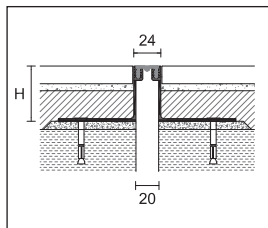

PBE/20 smooth rubber

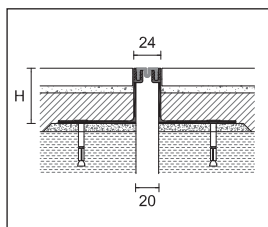

PBE/20 striated rubber

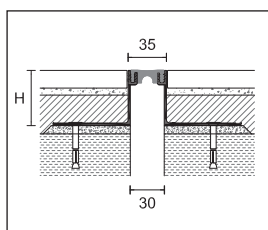

PBE/30 smooth rubber

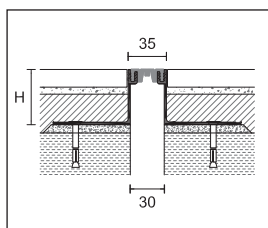

PBE/30 striated rubber

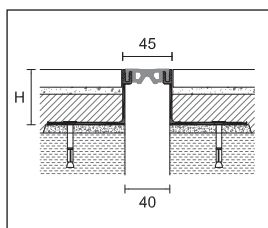

PBE/40 smooth rubber

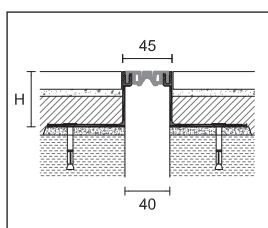

PBE/40 striated rubber

PROJOINT DIL

length = 300 cm - pack 5 pcs

ART.	finishing	14	24	42	50	82
ALUMINIUM						
	natural aluminium + smooth grey rubber	99321	99322	99323	99324	99325
	natural aluminium + smooth black rubber	99326	99327	99328	99329	99330
PBE/20 euro/m						
	natural aluminium + striated grey rubber	99331	99332	99333	99334	99335
	natural aluminium + striated black rubber	99336	99337	99338	99339	99340

no partial packaging - profiles are provided with accessories for mechanical fixing



smooth rubber



striated rubber

PROJOINT DIL

length = 300 cm - pack 5 pcs

ART.	finishing	14	24	42	50	82
ALUMINIUM						
	natural aluminium + smooth grey rubber	99341	99342	99343	99344	99345
	natural aluminium + smooth black rubber	99346	99347	99348	99349	99350
PBE/30 euro/m						
	natural aluminium + striated grey rubber	99351	99352	99353	99354	99355
	natural aluminium + striated black rubber	99356	99357	99358	99359	99360

no partial packaging - profiles are provided with accessories for mechanical fixing



smooth rubber



striated rubber

PROJOINT DIL

length = 300 cm - pack 5 pcs

ART.	finishing	14	24	42	50	82
ALUMINIUM						
	natural aluminium + smooth grey rubber	99361	99362	99363	99364	99365
	natural aluminium + smooth black rubber	99366	99367	99368	99369	99370
PBE/40 euro/m						
	natural aluminium + striated grey rubber	99371	99372	99373	99374	99375
	natural aluminium + striated black rubber	99376	99377	99378	99379	99380

no partial packaging - profiles are provided with accessories for mechanical fixing



smooth rubber



striated rubber

We suggest the use of the black insert.

Delivery times to be agreed.

Projoint DIL PBH and PAS are two structural joints composed of two L-shaped profiles in natural aluminium and an expanding part in interchangeable EPDM, available in black or grey. Projoint DIL PHDE is a structural joint composed of two interlocking and sliding profiles in natural aluminium. All profiles have drilled bases to allow the mechanical fixing with screws to the underlying structure and are designed to withstand structural movements of big buildings.



PBH/65/ natural aluminium + black EPDM insert

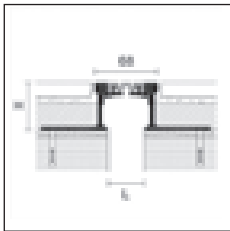

PBH/65



PROJOINT DIL

length = 300 cm - pack 2 pcs

		H			
ART.	finishing	18	35	50	80
ALUMINIUM		L=50	L=40	L=40	L=40
PBH/65/	natural aluminium + grey EPDM insert	99500	99501	99502	99503
	natural aluminium + black EPDM insert	99504	99505	99506	99507

euro/m

no partial packaging - profiles are provided with accessories for mechanical fixing

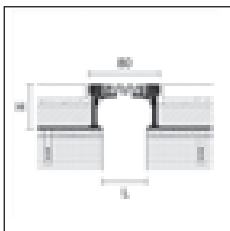

PBH/75

PROJOINT DIL

length = 300 cm - pack 2 pcs

		H			
ART.	finishing	18	35	50	80
ALUMINIUM		L=60	L=50	L=50	L=50
PBH/75/	natural aluminium + grey EPDM insert	99508	99509	99510	99511
	natural aluminium + black EPDM insert	99512	99513	99514	99515

euro/m

no partial packaging - profiles are provided with accessories for mechanical fixing

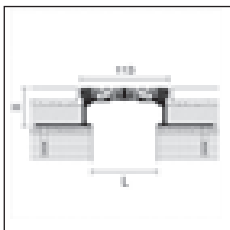

PAS/105



PROJOINT DIL

length = 300 cm - pack 2 pcs

		H			
ART.	finishing	18	35	50	80
ALUMINIUM		L=95	L=85	L=85	L=85
PAS/105/	natural aluminium + grey EPDM insert	99516	99517	99518	99519
	natural aluminium + black EPDM insert	99520	99521	99522	99523

euro/m

no partial packaging - profiles are provided with accessories for mechanical fixing

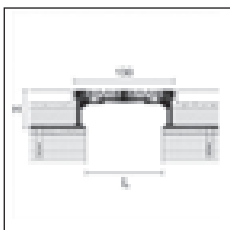

PAS/125

PROJOINT DIL

length = 300 cm - pack 2 pcs

		H			
ART.	finishing	18	35	50	80
ALUMINIUM		L=111	L=100	L=100	L=100
PAS/125/	natural aluminium + grey EPDM insert	99524	99525	99526	99527
	natural aluminium + black EPDM insert	99528	99529	99530	99531

euro/m

no partial packaging - profiles are provided with accessories for mechanical fixing

We suggest the use of the black insert.

cerfix® projoint

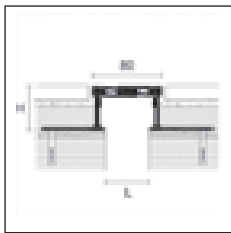

PHDE/80

PROJOINT DIL

length = 300 cm - pack 2 pcs		H			
ART.	finishing	18	35	50	80
ALUMINIUM		L=60	L=50	L=50	L=50
PHDE/80/	natural aluminium	99590	99591	99592	99593
	euro/m				

no partial packaging - profiles are provided with accessories for mechanical fixing

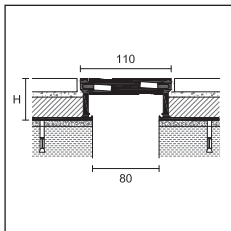

PHDE/110

PROJOINT DIL

length = 300 cm - pack 2 pcs		H			
ART.	finishing		50	80	
ALUMINIUM					
PHDE/110/	natural aluminium		99594		99595
	euro/m				

no partial packaging - profiles are provided with accessories for mechanical fixing

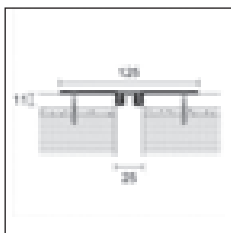

PFFE/20

PROJOINT DIL

length = 300 cm - pack 5 pcs					
ART.	finishing				
ALUMINIUM					
	natural aluminium + smooth grey rubber				99596
	natural aluminium + smooth black rubber				99597
PFFE/20	euro/m				
	natural aluminium + striated grey rubber				99598
	natural aluminium + striated black rubber				99599
	euro/m				

no partial packaging - profiles are provided with accessories for mechanical fixing



smooth rubber striated rubber

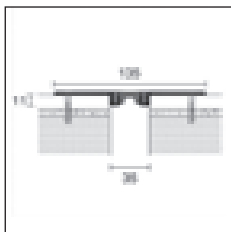

PFFE/30

PROJOINT DIL

length = 300 cm - pack 5 pcs					
ART.	finishing				
ALUMINIUM					
	natural aluminium + smooth grey rubber				99600
	natural aluminium + smooth black rubber				99601
PFFE/30	euro/m				
	natural aluminium + striated grey rubber				99602
	natural aluminium + striated black rubber				99603
	euro/m				

no partial packaging - profiles are provided with accessories for mechanical fixing



smooth rubber striated rubber

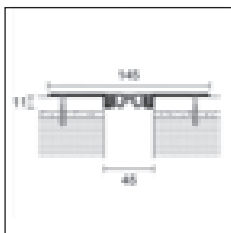

PFFE/40

PROJOINT DIL

length = 300 cm - pack 5 pcs					
ART.	finishing				
ALUMINIUM					
	natural aluminium + smooth grey rubber				99604
	natural aluminium + smooth black rubber				99605
PFFE/40	euro/m				
	natural aluminium + striated grey rubber				99606
	natural aluminium + striated black rubber				99607
	euro/m				

no partial packaging - profiles are provided with accessories for mechanical fixing



smooth rubber striated rubber

Procover Flex is a line of structural aluminium joint covers designed to withstand traction and compression transverse movements of large buildings.

They withstand both pedestrian and vehicular traffic with rubber wheels (cars).

Procover Fix is a line of flat joint cover profiles in aluminium for coplanar floors (GJA/) and perimeter joint cover profiles for the connection of floors and walls (GWA/), suitable to cover structural movements of expansion or compression of two different structures.

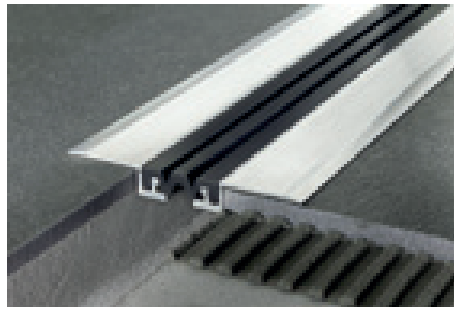

GJF/40 natural aluminium + EPDM black RAL 9005

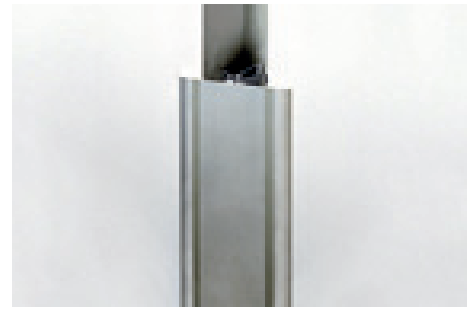

GJA/70 silver anodised aluminium

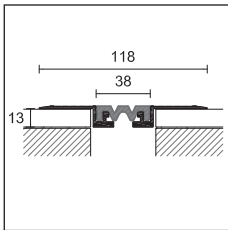

GJF/40



PROCOVER FLEX

length = 400 cm - pack 5 pcs

L

ART.	finishing	40	50
------	-----------	----	----

ALUMINIUM

GJF/	natural aluminium + EPDM black insert RAL 9005		74490	74492
	euro/m			

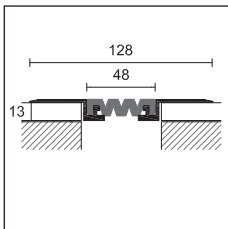

GJF/50

SPARE INSERT

length = 400 cm

L

ART.	finishing	40	50
------	-----------	----	----

ALUMINIUM

GM/	EPDM black RAL 9005		74491	74493
	euro/m			

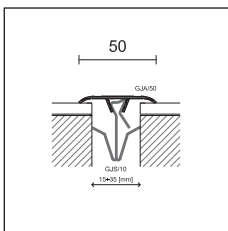

GJA/50



PROCOVER FIX

length = 300 cm - pack 10 pcs

L

ART.	finishing	50	70
------	-----------	----	----

ALUMINIUM

GJA/	silver anodised		74550	74610
	euro/m			
GWA/	silver anodised		-	74552
	euro/m		-	

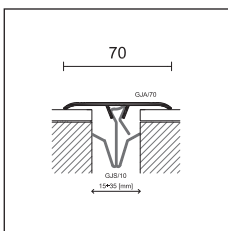

GJA/70

SPRING CLIP

from 15 to 35 mm - pack 50 pcs

STAINLESS STEEL

GJS/10	harmonic steel		74730
	euro/pc		

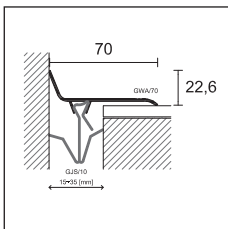

GWA/70

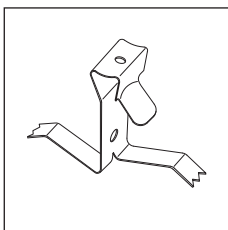

GJS/10

Complete the article code with L measure (for example GJF/ for L=40 becomes GJF/40)

cerfix® procover

Procover G in anodized aluminium are joint covering profiles, suitable for creating continuity on structures with continuous bays. These joint coverings are supplied with adhesive or are fixed with screws and dowels.

In this case it is perforated laterally, and fixed only to one structure allowing the free sliding over the other.



G/80/A silver anodised aluminium

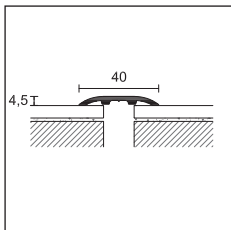

G/40/

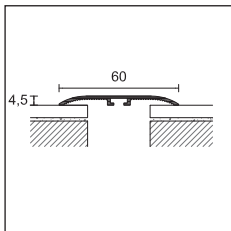

G/60/

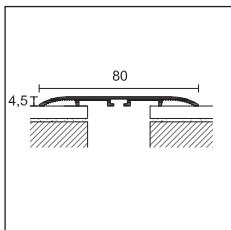

G/80/

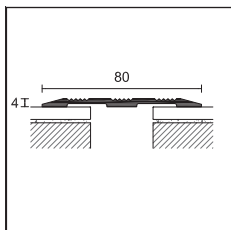

GR/80/SF

PROCOVER

pack	20 pcs	20 pcs	6 pcs / blister	20 pcs		
length cm	300	300	100	300		
ART.	G/40/	G/60/	G/460/	G/80/		
finishing	A	SF	A	AD	SF	A
ALUMINIUM						
silver anodised	74528	74558	74588	21982	74618	74648
euro/m				-		
euro/pc	-	-	-		-	-

art. G/40, G/60 and G/80 individually packed

PROCOVER

length = 270 cm - pack 10 pcs	L
width	80
ART.	GR/80/
finishing	SF
ALUMINIUM	
silver anodised	71855
euro/m	

individually packed



GR/80/SF silver anodised aluminium

Complete the article code with A-AD=adhesive, SF=undrilled (for example G/40/ adhesive becomes G/40/A)

packaging in blister no partial packaging

Procover G in stainless steel and polished brass are joint covering profiles, suitable for creating continuity on structures with continuous bays. These joint coverings are supplied with adhesive or are fixed with screws and dowels. In this case it is perforated laterally, and fixed only to one structure allowing the free sliding over the other. In these versions they are suitable even to vehicular traffic.

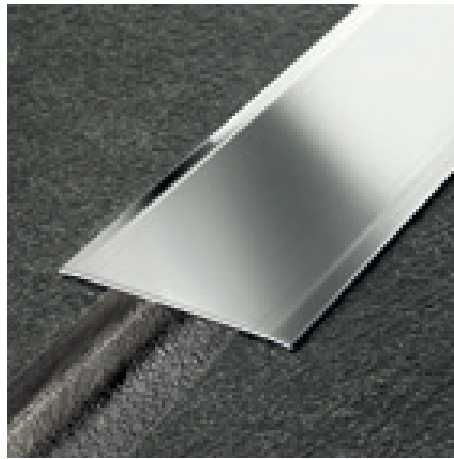

760/SF polished stainless steel AISI430-DIN 1.4016

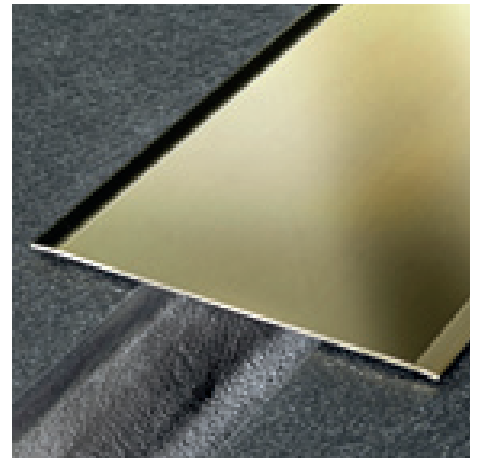

0100/A polished brass

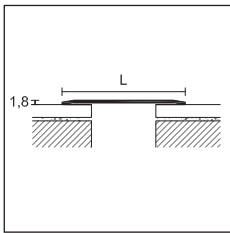

PROCOVER

	10 pcs		6 pcs / blister		10 pcs		6 pcs / blister		5 pcs		3 pcs / blister		5 pcs	
length cm	300		100		300		100		300		100		300	
width mm	50		50		60		60		80		80		100	
thickness	12/10													
ART.	750/		4750/		760/		4760/		780/		4780/		7100/	
finishing	SF	A	AD	SF	A	AD	SF	A	AD	SF	A	AD	SF	A

STAINLESS STEEL

polished stainless steel AISI 430 - DIN 1.4016	74818	74828	22090	74838	74848	40531	74858	74868	40553	74878	74888
euro/m	-	-	-	-	-	-	-	-	-	-	-
euro/pc	-	-	-	-	-	-	-	-	-	-	-

art. 750/, 760/, 780/, 7100/ individually packed

PROCOVER

	10 pcs		6 pcs / blister		5 pcs		6 pcs / blister		5 pcs		3 pcs / blister		5 pcs.	
length cm	300		100		300		100		300		100		300	
width mm	50		50		60		60		80		80		100	
thickness	13/10													
ART.	050/		4050/		060/		4060/		080/		4080/		0100/	
finishing	SF	A	AD	SF	A	AD	SF	A	AD	SF	A	AD	SF	A

STAINLESS STEEL

polished	74738	74748	22050	74758	74768	40504	-	74788	40512	74798	74808
euro/m	-	-	-	-	-	-	-	-	-	-	-
euro/pc	-	-	-	-	-	-	-	-	-	-	-

art. 050/, 060/, 080/, 0100/ individually packed

Complete the article code with A-AD=adhesive, SF=undrilled (eg. 050/ adhesive becomes 050/A)

 packaging in blister no partial packaging



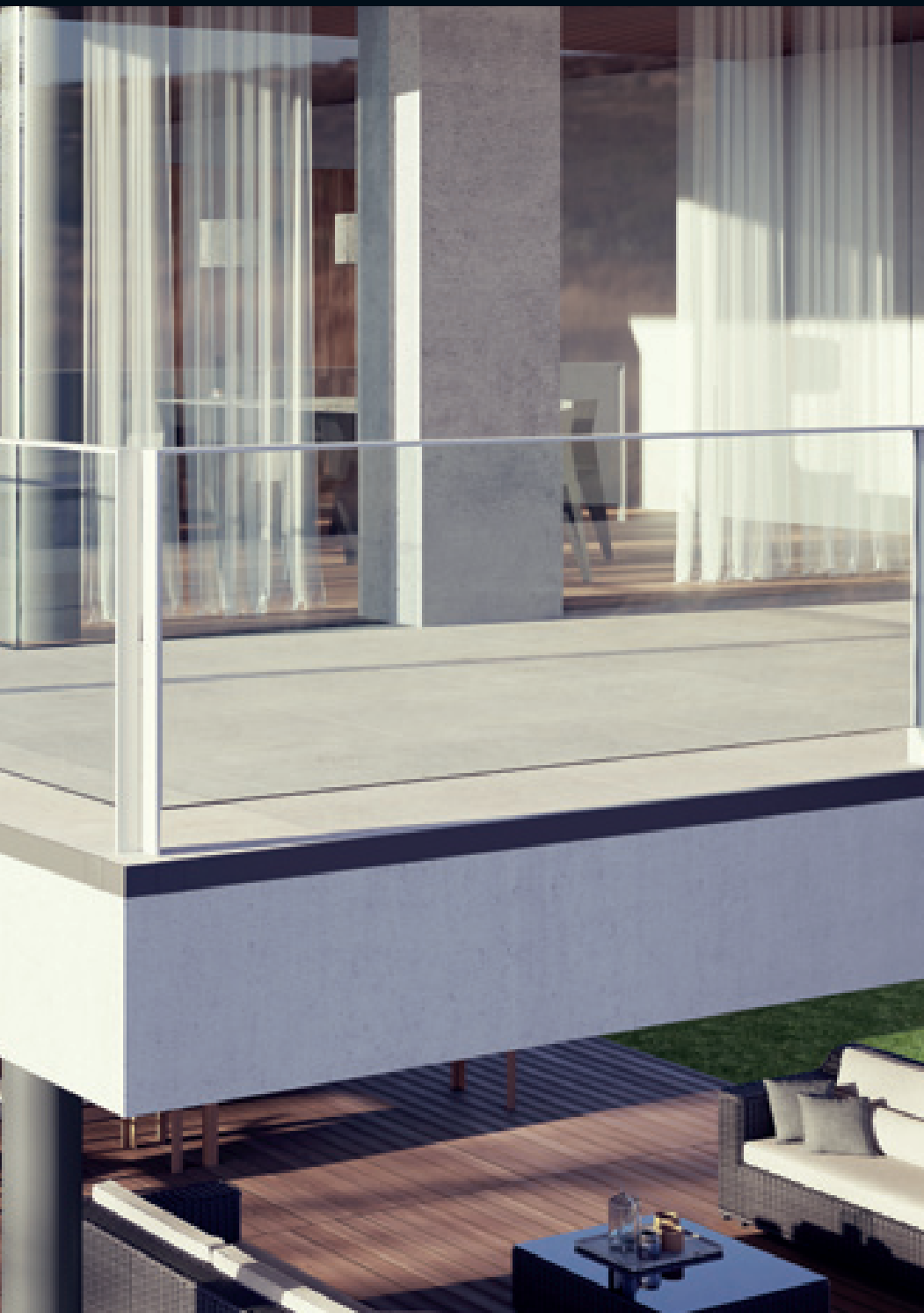

profiles for balconies and terraces

A functional and stylish line for the protection of terraces, balconies and pavements. The effectiveness of the protection decorates and completes every architectural detail.

Protec CPCV and CPCI are a series of edge profiles for the protection and the finishing of the outside edges of terraces and balconies. Available in colour-coated aluminium and stainless steel, they have been designed with a protruding section and can be used with tiles thicknesses up to 21 mm. In addition to protecting and finishing the outside edges, they guarantee the outflow of water from the floor, avoiding the contact with the outside border.

Protec CPCV is also available in the bendable version CPCVF, provided with a special cutout that allows to bend the profile with a radius up to 1 meter.

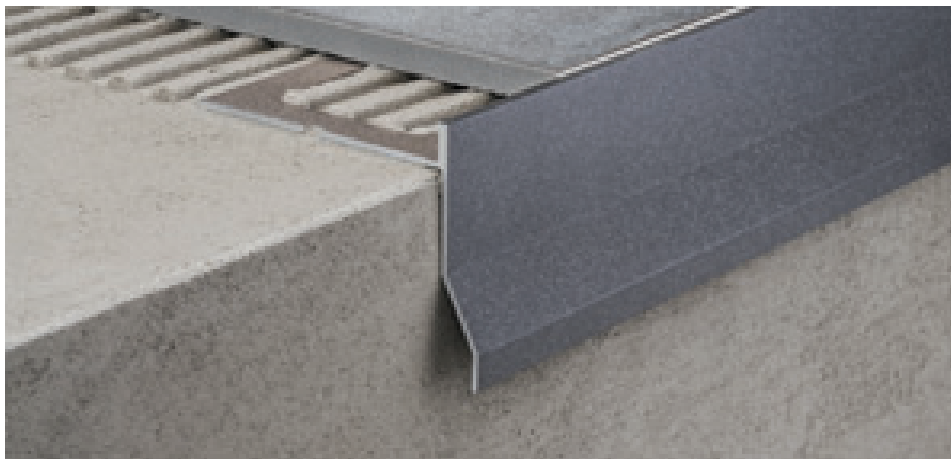

CPCV/55/10 ancient grey colour-coated aluminium

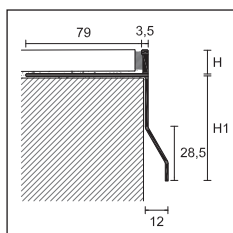

CPCV/



PROTEC

length = 270 cm - pack 5 pcs

ART.	H									
	10			12,5			21			
finishing	CPCV/55/			CPCV/75/			CPCV/95/			
COLOUR-COATED ALUMINIUM										
white RAL 9003		87677	87678	-	87687	87688	-	87697	87698	-
ash grey RAL 7038		87681	87682	87660	87691	87692	87661	87701	87702	87662
ash grey RAL 7038 embossed		87713	87714	-	87715	87716	-	87717	87718	-
dark brown RAL 8019		87683	87684	-	87693	87694	-	87703	87704	-
rust		87616	87617	-	87618	87619	-	-	-	-
metal grey RAL 9006		87720	87721	-	87723	87724	-	87726	87727	-
aluminium grey RAL 9007		87750	87751	-	87753	87754	-	87756	87757	-
ancient grey		87707	87708	-	87709	87710	-	87711	87712	-
euro/m										

For colours on request please contact our sales department

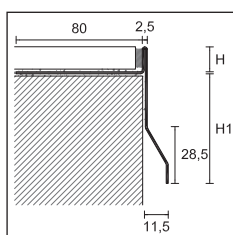

CPCI/

PROTEC

length = 270 cm - pack 5 pcs

ART.	H									
	10		12,5		21					
finishing	CPCI/55/		CPCI/75/		CPCI/95/					
STAINLESS STEEL										
polished stainless steel AISI 304 DIN 1.4301		87671	87672	-	87673	87674	-	87675	87676	-
euro/m										

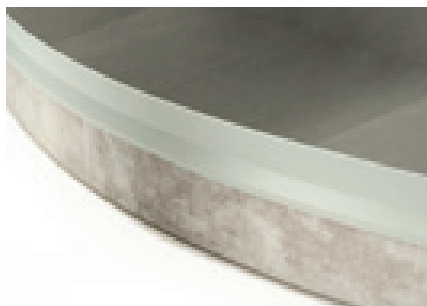

CPCVF/55/10 ash grey RAL 7038 embossed colour-coated aluminium

PROTEC FLEX FLEX LINE

length = 270 cm - pack 2 pcs

ART.	H		
	10	12,5	
finishing	CPCVF/55/		
COLOUR-COATED ALUMINIUM			
ash grey RAL 7038		87790	-
ash grey RAL 7038 embossed		87791	87793
ancient grey		87792	87794
euro/m			

no partial packaging

For colours on request and other heights please contact our sales department

Complete the article code with H measure (for example CPCV/55/ for H=10 becomes CPCV/55/10)

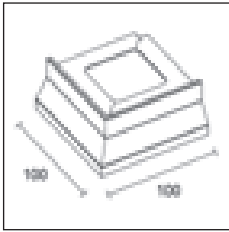

CPCV//E
CPCI//E

90° OUTSIDE CORNER

pack 5 pcs		H								
		10	12,5	21	10	12,5	21	10	12,5	21
ART.	finishing	CPCV/55/ /E			CPCV/75/ /E			CPCV/95/ /E		
COLOUR-COATED ALUMINIUM										
white RAL 9003		87817	87818	-	87827	87828	-	87837	87838	-
ash grey RAL 7038		87821	87822	87663	87831	87832	87664	87841	87842	87665
ash grey RAL 7038 embossed		87894	87895	-	87896	87897	-	87898	87899	-
dark brown RAL 8019		87825	87826	-	87835	87836	-	87845	87846	-
rust		87620	87621	-	87622	87623	-	-	-	-
metal grey RAL 9006		87730	87731	-	87733	87734	-	87736	87737	-
aluminium grey RAL 9007		87760	87761	-	87763	87764	-	87766	87767	-
ancient grey		87877	87878	-	87879	87880	-	87881	87882	-
euro/pc										

90° OUTSIDE CORNER

pack 5 pcs		H								
		10	12,5	10	12,5	10	12,5			
ART.	finishing	CPCI/55/ /E		CPCI/75/ /E		CPCI/95/ /E				
STAINLESS STEEL										
polished stainless steel AISI 304 DIN 1.4301		87801	87802	-	87803	87804	-	87805	87806	-
euro/pc										

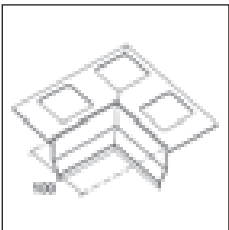

CPCV/55/ /I

90° INSIDE CORNER

pack 5 pcs		H					
		10	12,5				
ART.	finishing	CPCV/55/ /I					
COLOUR-COATED ALUMINIUM							
ash grey RAL 7038		87890	87891	-			
ash grey RAL 7038 embossed		87807	87808	-			
ancient grey		87892	87893	-			
euro/pc							

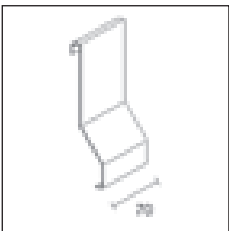

CPCV// /G
CPCI// /G

JUNCTION

width = 70 mm - pack 5 pcs		H								
		10	12,5	21	10	12,5	21	10	12,5	21
ART.	finishing	CPCV/55/ /G			CPCV/75/ /G			CPCV/95/ /G		
COLOUR-COATED ALUMINIUM										
white RAL 9003		87847	87848	-	87857	87858	-	87867	87868	-
ash grey RAL 7038		87851	87852	87666	87861	87862	87667	87871	87872	87668
ash grey RAL 7038 embossed		87748	87749	-	87758	87759	-	87768	87769	-
dark brown RAL 8019		87853	87854	-	87863	87864	-	87873	87874	-
rust		87624	87625	-	87626	87627	-	-	-	-
metal grey RAL 9006		87740	87741	-	87743	87744	-	87746	87747	-
aluminium grey RAL 9007		87770	87771	-	87773	87774	-	87776	87777	-
ancient grey		87883	87884	-	87885	87886	-	87887	87888	-
euro/pc										

no partial packaging

JUNCTION

width = 70 mm - pack 5 pcs		H								
		10	12,5	10	12,5	10	12,5			
ART.	finishing	CPCI/55/ /G		CPCI/75/ /G		CPCI/95/ /G				
STAINLESS STEEL										
polished stainless steel AISI 304 DIN 1.4301		87811	87812	-	87813	87814	-	87815	87816	-
euro/pc										

no partial packaging



CPCV/55/E + CPCV/55/G ancient grey colour-coated aluminium

Protec CPCV/30/ is the solution for old terraces. The reduced dimensions of the protruding section allow to avoid removing the perimetral balustrades in case of refurbishment.



CPCV/30/ ancient grey colour-coated aluminium

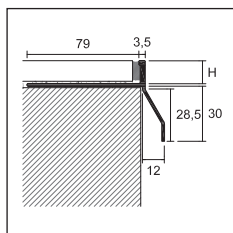

CPCV/30/



PROTEC

length = 270 cm - pack 5 pcs

		H	
		10	12,5
ART.		CPCV/30/10	CPCV/30/12
finishing			
COLOUR-COATED ALUMINIUM			
ash grey RAL 7038		87651	87652
ash grey RAL 7038 embossed		87655	87656
ancient grey		87653	87654
euro/m			

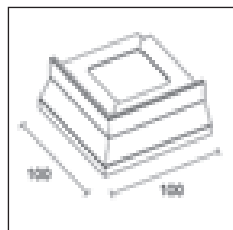

CPCV/30/ / E

90° OUTSIDE CORNER

pack 5 pcs

		H	
		10	12,5
ART.	finishing	CPCV/30/10/E	CPCV/30/12/E
COLOUR-COATED ALUMINIUM			
ash grey RAL 7038		87780	87781
ash grey RAL 7038 embossed		87784	87785
ancient grey		87782	87783
euro/pc			

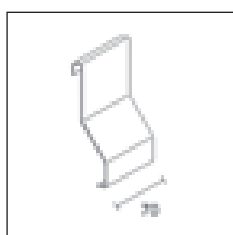

CPCV/30/ /G

JUNCTION

width = 70 mm - pack 5 pcs

		H	
		10	12,5
ART.	finishing	CPCV/30/10/G	CPCV/30/12/G
COLOUR-COATED ALUMINIUM			
ash grey RAL 7038		87631	87632
ash grey RAL 7038 embossed		87635	87636
ancient grey		87633	87634
euro/pc			

no partial packaging

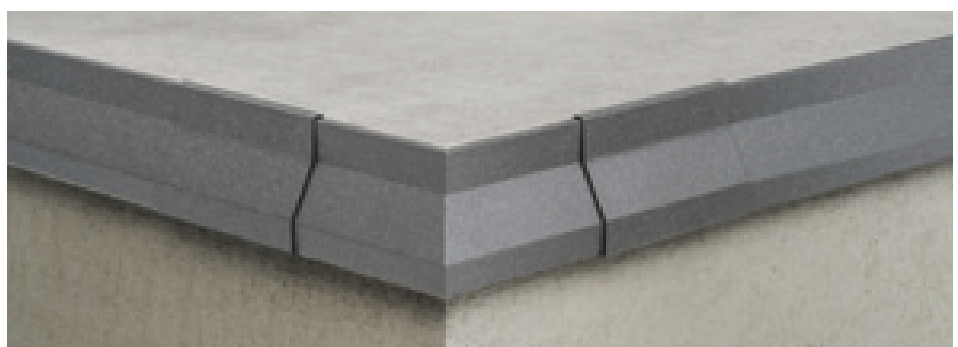

CPCV/30/ /E ancient grey colour-coated aluminium

Complete the article code with H measure (for example CPCV/30/ for H=10 becomes CPCV/30/10)

Protec CPCVD/30/ is a draining perimeter profile, provided with a visible part that facilitates the outflow of rainwater from the tiled surface and an underlying protruding part equipped with holes for a further discharge of the water seeped under the tiles. The reduced dimensions of the visible part allow to avoid removing the perimetral balustrades in case of refurbishment.



CPCVD/30/10 ash grey RAL 7038 embossed colour-coated aluminium

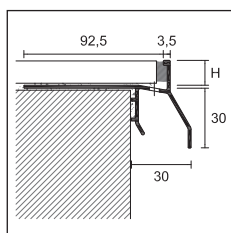

CPCVD/30/



PROTEC

length = 270 cm - pack 5 pcs

		H	
		10	12,5
ART.		CPCVD/30/10	CPCVD/30/12
finishing			
COLOUR-COATED ALUMINIUM			
ash grey RAL 7038		87613	87628
ash grey RAL 7038 embossed		87614	87629
ancient grey		87615	87630
euro/m			

NEW

90° OUTSIDE CORNER

pack 5 pcs

		H	
		10	12,5
ART.	finishing	CPCVD/30/10/E	CPCVD/30/12/E
COLOUR-COATED ALUMINIUM			
ash grey RAL 7038		87645	87648
ash grey RAL 7038 embossed		87646	87649
ancient grey		87647	87650
euro/pc			

NEW

JUNCTION

width = 70 mm - pack 5 pcs

		H	
		10	12,5
ART.	finishing	CPCVD/30/10/G	CPCVD/30/12/G
COLOUR-COATED ALUMINIUM			
ash grey RAL 7038		87657	87669
ash grey RAL 7038 embossed		87658	87670
ancient grey		87659	87719
euro/pc			

no partial packaging

white RAL 9003, dark brown RAL 8019, rust, metal grey RAL 9006 and aluminium grey RAL 9007 with a minimum of 270 meters, on request, without surcharge.

For colours on request please contact our sales department.

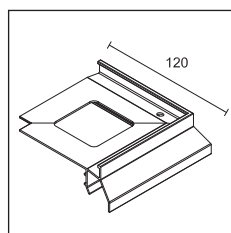

CPCVD/30/ E

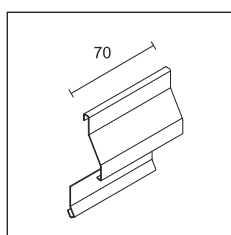

CPCVD/30/ G

Complete the article code with H measure (for example CPCVD/30/ for H=10 becomes CPCVD/30/10)

Protec CPGV is a perimetral profile for the protection and finishing of the outside edges of terraces and balconies. This profile is composed of a vertical part that facilitates the outflow of rainwater from the tiled surface and protects the border of the floor, and a sloping part equipped with holes for a further discharge of the water seeped under the tiles. This technical solution and the consequent drainage reduce the problems of freezing and thawing and the unsightly efflorescences on the tiles grouts. It can be used with tiles thicknesses up to 12,5 mm.



CPGV/55/10 ancient grey colour-coated aluminium

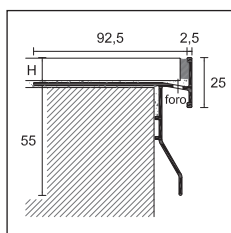

CPGV/55/



PROTEC

length = 270 cm - pack 5 pcs

		H	
		10	12,5
ART.	finishing	CPGV/55/10	CPGV/55/12
COLOUR-COATED ALUMINIUM			
	ash grey RAL 7038	87580	87581
	ash grey RAL 7038 embossed	87578	87579
	metal grey RAL 9006	87590	87591
	ancient grey	87582	87583
	white stone	87547	87548
<i>euro/m</i>			

white RAL 9003, dark brown RAL 8019 and aluminium grey RAL 9007 with a minimum of 270 meters, on request, without surcharge. For colours on request please contact our sales department.

90° OUTSIDE CORNER

pack 5 pcs

		H	
		10	12,5
ART.	finishing	CPGV/55/10/E	CPGV/55/12/E
COLOUR-COATED ALUMINIUM			
	ash grey RAL 7038	87584	87585
	ash grey RAL 7038 embossed	87595	87596
	metal grey RAL 9006	87592	87593
	ancient grey	87586	87587
	white stone	87536	87537
<i>euro/pc</i>			

90° INSIDE CORNER

pack 5 pcs

		H	
		10	12,5
ART.	finishing	CPGV/55/10/I	CPGV/55/12/I
COLOUR-COATED ALUMINIUM			
	ancient grey	87566	87567
	white stone	87538	87539
<i>euro/pc</i>			

JUNCTION

width = 70 mm - pack 5 pcs

		H	
		10	12,5
ART.	finishing	CPGV/55/10/G	CPGV/55/12/G
COLOUR-COATED ALUMINIUM			
	ash grey RAL 7038	87610	87610
	ash grey RAL 7038 embossed	87612	87612
	metal grey RAL 9006	87594	87594
	ancient grey	87611	87611
	white stone	87528	87528
<i>euro/pc</i>			

no partial packaging

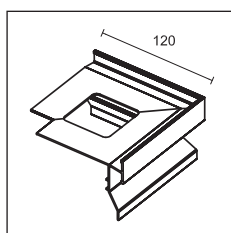

CPGV/55/ /E

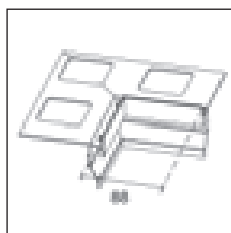

CPGV/55/ /I

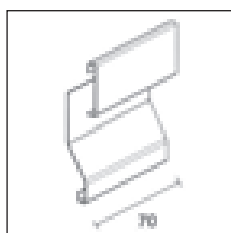

CPGV/55/ /G

Protec CPQV is a perimetral profile for the protection and finishing of the outside edges of terraces and balconies. This profile is composed of a vertical part that covers the border of the floor and facilitates the outflow of rainwater from the tiled surface, and a sloping part equipped with holes for a further discharge of the water seeped under the tiles. This technical solution and the consequent drainage reduce the problems of freezing and thawing and the unsightly efflorescences on the tiles grouts. It can be used with tiles thicknesses up to 12,5 mm.

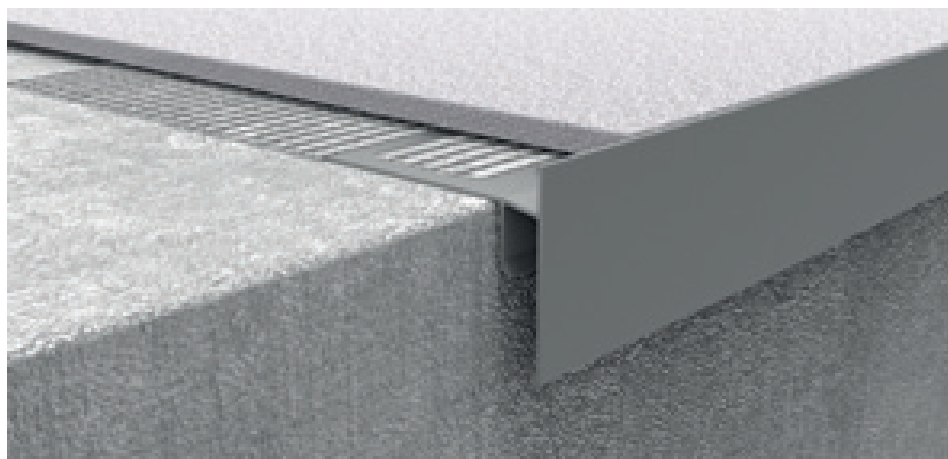

CPQV/50/10 ash grey RAL 7038 embossed colour-coated aluminium

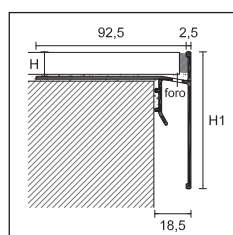

CPQV

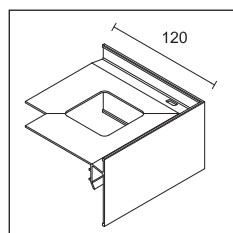

CPQV//E

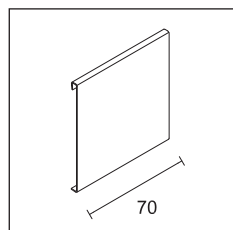

CPQV//G



CPQV ash grey RAL 7038

PROTEC

length = 270 cm - pack 5 pcs

		H			
		10	12,5	10	12,5
ART.	finishing	CPQV/50/ (H1=50)		CPQV/70/ (H1=70)	
COLOUR-COATED ALUMINIUM					
	ash grey RAL 7038	86960	86961	86962	86963
	ash grey RAL 7038 embossed	86964	86965	86966	86967
	metal grey RAL 9006	86968	86969	86970	86971
	ancient grey	86972	86973	86974	86975
	white stone	86976	86977	86978	86979
euro/m					

white RAL 9003, dark brown RAL 8019 and aluminium grey RAL 9007 with a minimum of 270 meters, on request, without surcharge. For colours on request please contact our sales department.

90° OUTSIDE CORNER

pack 5 pcs

		H			
		10	12,5	10	12,5
ART.	finishing	CPQV/50/ /E		CPQV/70/ /E	
COLOUR-COATED ALUMINIUM					
	ash grey RAL 7038	86980	86981	86982	86983
	ash grey RAL 7038 embossed	86984	86985	86986	86987
	metal grey RAL 9006	86988	86989	86990	86991
	ancient grey	86992	86993	86994	86995
	white stone	86996	86997	86998	86999
euro/pc					

JUNCTION

width = 70 mm - pack 5 pcs

		H	
		CPQV/50/G	CPQV/70/G
ART.	finishing	CPQV/50/G	
COLOUR-COATED ALUMINIUM			
	ash grey RAL 7038	87000	87001
	ash grey RAL 7038 embossed	87002	87003
	metal grey RAL 9006	87004	87005
	ancient grey	87006	87007
	white stone	87008	87009
euro/pc			

no partial packaging

Complete the article code with H measure (for example CPQV/50/ for H=12,5 becomes CPQV/50/12)

Protec CPEV and CPEI are a series of edge reversible profiles for the protection and finishing of the outside edges of terraces and balconies.

Available in stainless steel and colour-coated aluminium, they can be installed flush with the border or detached from it. They can be used with tiles or marble thicknesses from 11 to 32 mm.

The particular section is recommended to protect the stair nosing and sidewalk edge, hiding the connection between tread and riser.

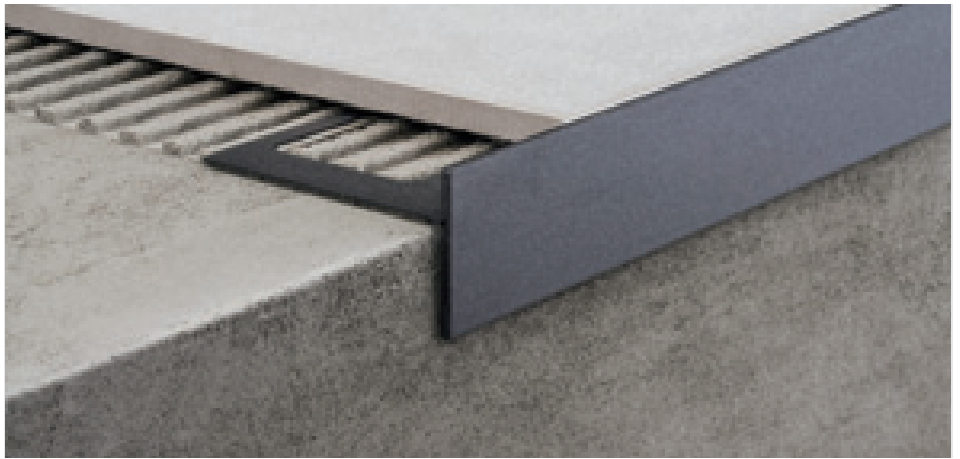

CPEV/45/12 ancient grey colour-coated aluminium

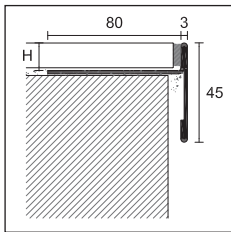

CPEV/45/

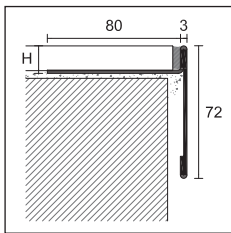

CPEV/72/

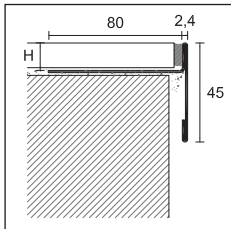

CPEI/



PROTEC

length = 270 cm - pack 5 pcs

		H				
		11	12,5	15	20	12,5

ART.	CPEV/45/				CPEV/72/
finishing					

COLOUR-COATED ALUMINIUM

ash grey RAL 7038		87530	87550	87551	87552	87252
metal grey RAL 9006		87531	87540	87541	87542	-
ancient grey		87532	87553	87554	87555	-

euro/m

for CPEV/72 white RAL 9003, dark brown RAL 8019, metal grey RAL 9006, aluminium grey RAL 9007, ancient grey, ash grey RAL 7038 embossed and rust with minimum 270 meters, on request, without surcharge. For different colours, please contact our Sales Department. For CPEV/45 white RAL 9003, dark brown RAL 8019, aluminium grey RAL 9007, ash grey RAL 7038 embossed and rust with minimum 270 meters, on request, without surcharge. For colours on request please contact our sales department.

PROTEC

length = 270 cm - pack 10 pcs

		H		
		12,5	15	20

ART.	CPEI/45/		
------	----------	--	--

STAINLESS STEEL

polished stainless steel AISI 304 DIN 1.4301		-	87570	87571	87572
---	---	---	-------	-------	-------

euro/m

Complete the article code with H measure
(for example CPEV/45/ for H=12,5 becomes
CPEV/45/12)

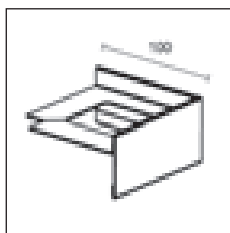

CPEV// /E
CPEI// /E

90° OUTSIDE CORNER

pack 5 pcs		H				
		11	12,5	15	20	12,5
ART.	CPEV/45/ /E					CPEV/72/ /E
finishing						
COLOUR-COATED ALUMINIUM						
ash grey RAL 7038		87533	87556	87557	87558	87255
metal grey RAL 9006		87534	87543	87544	87545	-
ancient grey		87535	87559	87560	87561	-
euro/pc						

90° OUTSIDE CORNER

pack 5 pcs		H				
		12,5	15	20		
ART.	CPEI/45/ /E					
finishing						
STAINLESS STEEL						
polished stainless steel AISI 304 DIN 1.4301		-	87573	87574	87575	
euro/pc						

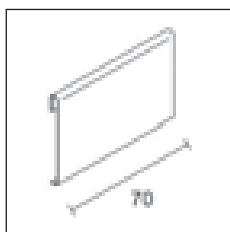

CPEV// /G
CPEI// /G

JUNCTION

width = 70 mm - pack 5 pcs		H				
		11	12,5	15	20	12,5
ART.	CPEV/45/ /G					CPEV/72/ /G
finishing						
COLOUR-COATED ALUMINIUM						
ash grey RAL 7038		87562	87562	87562	87562	87258
metal grey RAL 9006		87546	87546	87546	87546	-
ancient grey		87563	87563	87563	87563	-
euro/pc						

no partial packaging

JUNCTION

width = 70 mm - pack 5 pcs		H				
		12,5	15	20		
ART.	CPEI/45/ /G					
finishing						
STAINLESS STEEL						
polished stainless steel AISI 304 DIN 1.4301		-	87576	87576	87576	
euro/pc						

no partial packaging



CPEV/45/12/E + CPEV/45/12/G ancient grey colour-coated aluminium

Complete the article code with H measure
(for example CPEV/45/ for H=12,5 becomes
CPEV/45/12)

cerfix® protec

Protec CPNV is a series of edge profiles for the protection and the finishing of the outside edges of terraces and balconies. Available in colour-coated aluminium, they can be installed flush with the border or detached from it. Their special section makes them suitable for the protection of the borders of steps or sidewalks, since it hides the junction between the tread and the riser.

Protec CPNV is also available in the bendable version CPNVF, provided with a special cutout that allows to bend the profile with a radius up to 40 cm.



CPNV/45/ ash grey RAL 7038 embossed colour-coated aluminium

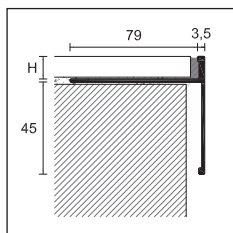

CPNV/45/



PROTEC

length = 270 cm - pack 5 pcs

ART.	finishing	10	11	12,5	NEW 21
------	-----------	----	----	------	--------

COLOUR-COATED ALUMINIUM

CPNV/45/	finishing	10	11	12,5	NEW 21
	ash grey	87270	87271	87272	87292
	RAL 7038 embossed				
	ancient grey	87273	87274	87275	87293

euro/m

white RAL 9003, dark brown RAL 8019, metal grey RAL 9006, aluminium grey RAL 9007, ash grey RAL 7038 and rust with a minimum of 270 meters, on request, without surcharge. For colours on request please contact our sales department.

90° OUTSIDE CORNER

pack 5 pcs

ART.	finishing	10	11	12,5	NEW 21
------	-----------	----	----	------	--------

COLOUR-COATED ALUMINIUM

CPNV/45/ /E	finishing	10	11	12,5	NEW 21
	ash grey	87276	87277	87278	87294
	RAL 7038 embossed				
	ancient grey	87279	87280	87281	87295

euro/pc

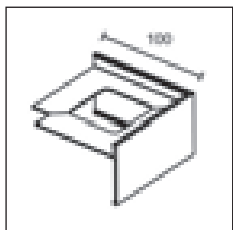

CPNV/45/ /E

JUNCTION

width = 70 mm - pack 5 pcs

ART.	finishing	10	11	12,5	NEW 21
------	-----------	----	----	------	--------

COLOUR-COATED ALUMINIUM

CPNV/45/ /G	finishing	10	11	12,5	NEW 21
	ash grey	87282	87283	87284	87296
	RAL 7038 embossed				
	ancient grey	87285	87286	87287	87297

euro/pc

no partial packaging

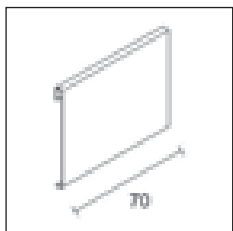

CPNV/45/ /G

PROTEC FLEX FLEX LINE

length = 270 cm - pack 2 pcs

ART.	finishing	10	12,5
------	-----------	----	------

COLOUR-COATED ALUMINIUM

CPNVF/45/	finishing	10	12,5
	ash grey	87288	87290
	RAL 7038 embossed		
	ancient grey	87289	87291

euro/m

no partial packaging

For colours on request and other heights please contact our sales department.



CPNVF/45/10 ancient grey colour-coated aluminium

Complete the article code with H measure (for example CPNV/45/ for H=10 becomes CPNV/45/10)

Protec CPBV is a series of edge profiles for the protection and the finishing of the outside edges of terraces and balconies. Available in colour-coated aluminium, they have been designed with a protruding section. In addition to protecting and finishing the outside edges, they guarantee the outflow of water from the floor, avoiding the contact with the outside border. They can be installed with tiles or marble of any thickness.

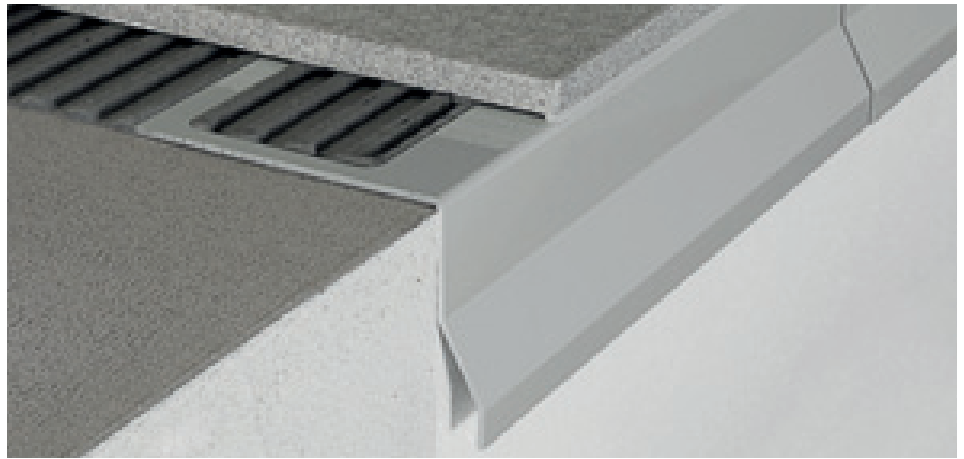

CPBV/55 ash grey RAL 7038 colour-coated aluminium

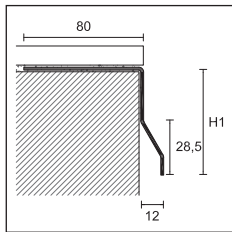

CPBV/

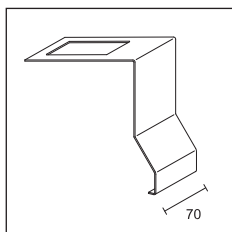
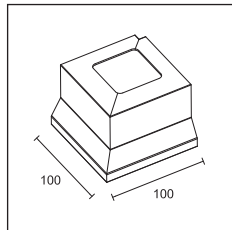

PROTEC

length = 270 cm - pack 5 pcs

ART.	finishing	55	75	95
------	-----------	----	----	----

COLOUR-COATED ALUMINIUM

CPBV/	ash grey RAL 7038		87332	87334	87336
	ancient grey		87333	87335	87337
<i>euro/m</i>					

white RAL 9003, dark brown RAL 8019, rust, metal grey RAL 9006 and aluminium grey RAL 9007 with a minimum of 270 meters, on request, without surcharge.
For colours on request please contact our sales department.

90° OUTSIDE CORNER

pack 5 pcs

ART.	finishing	55	75	95
------	-----------	----	----	----

COLOUR-COATED ALUMINIUM

CPBV/ /E	ash grey RAL 7038		87402	87404	87406
	ancient grey		87403	87405	87407
<i>euro/pc</i>					

JUNCTION

width = 70 mm - pack 5 pcs

ART.	finishing	55	75	95
------	-----------	----	----	----

COLOUR-COATED ALUMINIUM

CPBV/ /G	ash grey RAL 7038		87462	87464	87466
	ancient grey		87463	87465	87467
<i>euro/pc</i>					

no partial packaging



CPBV/55/E + CPBV/55/G ash grey RAL 7038 colour-coated aluminium

Complete the article code with H1 measure (for example CPBV/ for H1=55 becomes CPBV/55)

cerfix® protec

Protec CPHA - CPHV is an edge profile in anodised and colour-coated aluminium for terraces, balconies and sidewalks. The shape allows the outflow of water, avoiding the direct contact with the screed. Installed along the perimeter, it allows to outline the ceramic tiles and to protect the border in many fields of use. It can be used with tiles thicknesses up to 21 mm.



CPHA/10 silver anodised aluminium

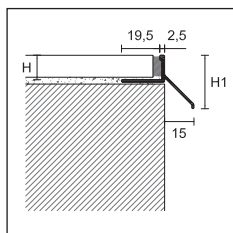

CPHA/
CPHV/



PROTEC

length = 270 cm - pack 10 pcs

		H (H1)			
ART.	finishing	8 (23)	10 (25)	12,5 (27)	21 (36)

ALUMINIUM

CPHA/	silver anodised		87599	87600	87601	87602
			<i>euro/m</i>			

COLOUR-COATED ALUMINIUM

CPHV/	ash grey RAL 7038		-	87606	87607	87608
	ash grey RAL 7038 embossed		-	87637	87638	-
	ancient grey		-	87639	87640	-
			<i>euro/m</i>			

white RAL 9003, dark brown RAL 8019, metal grey RAL 9006, aluminium grey RAL 9007 and ancient grey with a minimum of 270 meters, on request, without surcharge. For colours on request please contact our sales department.

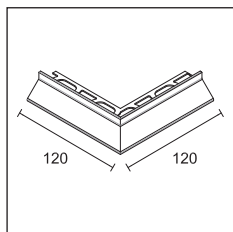

CPHA/ E
CPHV/ E

90° OUTSIDE CORNER

dimension = 12x12 cm - pack 5 pcs

		H (H1)			
ART.	finishing	8 (23)	10 (25)	12,5 (27)	21 (36)

ALUMINIUM

CPHA/ E	silver anodised		87564	87565	87597	87598
			<i>euro/pc</i>			

COLOUR-COATED ALUMINIUM

CPHV/ E	ash grey RAL 7038		-	87603	87604	87609
	ash grey RAL 7038 embossed		-	87641	87642	-
	ancient grey		-	87643	87644	-
			<i>euro/pc</i>			



CPHA/ E silver anodised aluminium

Complete the article code with H measure (for example CPHA/ for H=10 becomes CPHA/10)

Protec CPLV is a line of perimetral profiles in colour-coated aluminium, for the protection and finishing of the borders of outdoor raised floors, terraces or balconies. They are composed of a drilled base CPLB to be screwed to the supports, or, as an alternative, a cut base CPLB/2 for glued tiles, and a visible profile to be fixed with adhesive, available in 3 different heights according to the floor thickness. There are also special accessories for the creation of external corners and junctions.



CPLB + CPLV/60 ash grey RAL 7038 colour-coated aluminium

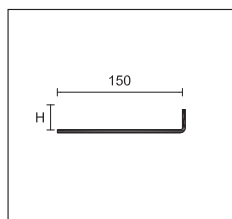
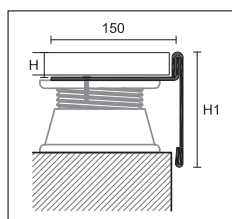

CPLB
base for raised
floors

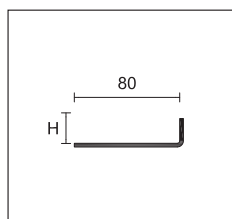

CPLB/2
punched base
for tiled floors

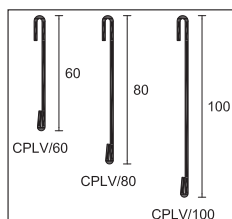

CPLV/

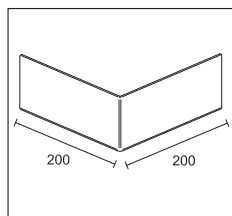

CPLV/ E

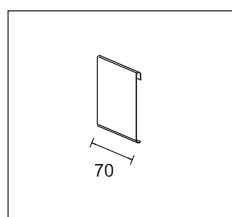

CPLV/ G

PROTEC

length = 270 cm - pack 10 pcs

H

BASE

ART. finishing

20

ALUMINIUM

CPLB natural aluminium
euro/m

86900

CPLB/2 natural aluminium
euro/m

86901

CPLB with draining holes available on request, extra euro/m
CPLB and CPLB/2 in 15 and 25 mm height available on request

possibility to choose noise-proof rubber PPL/GM, see Catalogue of Supports for raised floors 2024_01

PROTEC

length = 270 cm - pack 10 pcs

H1

FRONT

ART. finishing

60

80

100

COLOUR-COATED ALUMINIUM

CPLV/
ash grey RAL 7038
ancient grey
stone
greige
sand
beige
euro/m



86902
86903
86908
86911
86914
86917

86904
86905
86909
86912
86915
86918

86906
86907
86910
86913
86916
86919

white RAL 9003, dark brown RAL 8019, metal grey RAL 9006, aluminium grey RAL 9007, ash grey RAL 7038 embossed and rust with a minimum of 270 meters, on request, without surcharge. For other colours please contact our sales department.

90° OUTSIDE CORNER

pack 5 pcs

H1

ART. finishing

60

80

100

COLOUR-COATED ALUMINIUM

CPLV/ E
ash grey RAL 7038
ancient grey
stone
greige
sand
beige
euro/pc



86920
86921
86926
86929
86935
86938

86922
86923
86927
86931
86936
86939

86924
86925
86928
86933
86937
86940

JUNCTION

width = 70 mm - pack 5 pcs

H1

ART. finishing

60

80

100

COLOUR-COATED ALUMINIUM

CPLV/ G
ash grey RAL 7038
ancient grey
stone
greige
sand
beige
euro/pc



86930
86941
86944
86947
86950
86953

86932
86942
86945
86948
86951
86954

86934
86943
86946
86949
86952
86955

no partial packaging





stair nosing profiles

Protection, finishing and safety. Protect and Prostep are two ranges of stair nosing profiles for stairs for public and private use.

stair nosing profiles

cerfix® prostep

Prostep SGA, SGI, SGN and SGK are profiles for the realization and protection of ceramic, marble and stone steps. Thanks to the rounded section, they give elegance to the steps. The models in chromium-plated brass and anodized aluminium are not recommended in case of intense foot traffic, while those in stainless steel are particularly suitable for heavy foot traffic.



SGI/11 polished stainless steel AISI 304 DIN 1.4301

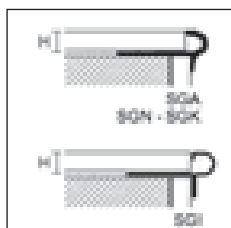

PROSTEP

length = 270 cm - pack 10 pcs

ART. finishing		H				
		7	9	11	13	
ALUMINIUM						
SGA/	silver anodised	94965	94966	94967	94968	
<i>euro/m</i>						
STAINLESS STEEL						
SGI/	polished stainless steel AISI 304 DIN 1.4301	-	94922	94924	-	-
<i>euro/m</i>		-			-	-
BRASS						
SGN/	natural brass	94970	94971	94972	-	-
<i>euro/m</i>						
CHROMIUM-PLATED BRASS						
SGK/	chromium-plated brass	94980	94981	94982	-	-
<i>euro/m</i>						

PPDESIGN

individually packed - art. SGK/9 and SGK/11 pack 5 pcs

Prostep SMA and SM are aluminium and brass profiles for realization and protection of ceramic, marble and stone steps. Thanks to the grooved top part, they are consistent with DIN 51131 law concerning non-slip stair nosing.



SMA/4,5 natural aluminium

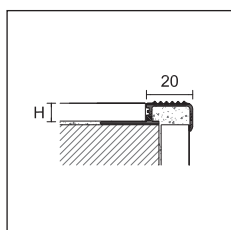

SMA/
SM/

PROSTEP

length= 270 cm - pack 10 pcs

ART. finishing		H				
		4,5	8	10	11	12,5
ALUMINIUM						
	natural aluminium	93967	93969	93970	93979	93971
<i>euro/m</i>						
SMA/	silver anodised	93975	93976	93977	93980	93978
<i>euro/m</i>						
BRASS						
SM/	natural brass	-	-	93972	-	93973
<i>euro/m</i>		-	-		-	

individually packed

Complete the article code with H measure (for example for SGA/ for H=11 becomes SGA/11)

Protrim IPI/ are minimal profiles in aluminium or stainless steel suitable for the edging of external corners that need the 45 degrees cut. These profiles allow a perfect laying both on coverings and on stairs or platforms in ceramic or wood.



IPA/11 silver anodised aluminium

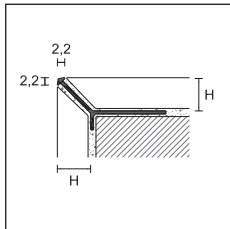

IPA/
IPB/



PROTRIM IP

length = 270 cm - pack 20 pcs

		H			
ART.	finishing	4,5	8	11	15
ALUMINIUM					
IPA/	silver anodised	95006	95178	95181	95185
	euro/m				
IPB/	bright polished silver	95008	-	-	-
	euro/m				

individually packed

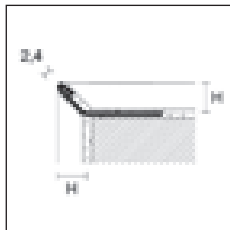

IPI/

PROTRIM IP

length = 270 cm - pack 20 pcs

		H			
ART.	finishing	7	8	11	12,5
STAINLESS STEEL					
IPI/	stainless steel AISI 304 - DIN 1.4301	95169	95170	95173	95174
	euro/m				

individually packed

Prostep SNG and SN are aluminium and brass profiles for realization and protection of ceramic, marble and stone steps.



SNG/10 silver anodised aluminium

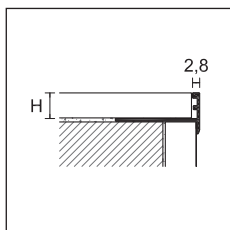

SNG/
SN/



PROSTEP

length = 270 cm - pack 20 pcs

		H			
ART.	finishing	8	10	12,5	15
ALUMINIUM					
	natural aluminium	90040	90042	90044	90046
	euro/m				
SNG/	silver anodised	90041	90043	90045	90047
	euro/m				
SN/	natural brass	93991	93992	93993	-
	euro/m				

individually packed - SN/ pack 10 pcs

Complete the article code with H measure (for example IPA/ for H=11 becomes IPA/11)

stair nosing profiles

cerfix® prostep

Prostep SAR and SIR are stair nosing profiles in aluminium and stainless steel, suitable for the protections of steps or pavements. Thanks to the reversible shapes, these two models can be used for tiles of four different thicknesses.



SAR/10/12 silver anodised aluminium



SIR/10/12 stainless steel AISI 304 DIN 1.4301

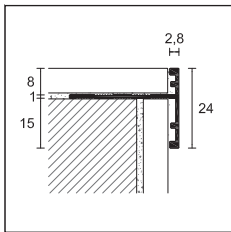

SAR/8

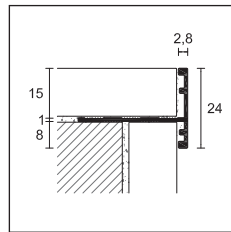

SAR/15

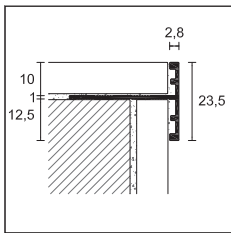

SAR/10

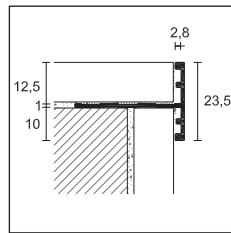

SAR/12

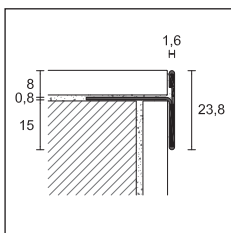

SIR/8
SIRS/8

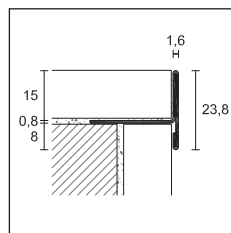

SIR/15
SIRS/15

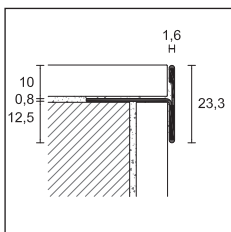

SIR/10
SIRS/10

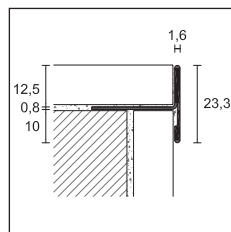

SIR/12
SIRS/12

PROSTEP

length = 270 cm - pack 10 pcs

ART. finishing

ALUMINIUM

SAR/8/15	silver anodised		93956
	euro/m		
SAR/10/12	silver anodised		93958
	euro/m		

individually packed

PROSTEP

length = 270 cm - pack 10 pcs

ART. finishing

STAINLESS STEEL

SIR/8/15	polished stainless steel AISI 304 DIN 1.4301		93952
	euro/m		
SIR/10/12	polished stainless steel AISI 304 DIN 1.4301		93954
	euro/m		
SIRS/8/15	brushed stainless steel AISI 304 DIN 1.4301		93953
	euro/m		
SIRS/10/12	brushed stainless steel AISI 304 DIN 1.4301		93955
	euro/m		

individually packed

Prostep SIS is a stainless steel profile for the realization and protection of ceramic, marble and stone steps. Thanks to the brushed and knurled tread, it is compliant with non-slip stair regulation DIN 51131. Prostep SIS is particularly suitable for the protection of steps subject to heavy pedestrian traffic.



SIS/10 brushed stainless steel AISI 304 - DIN 1.4301

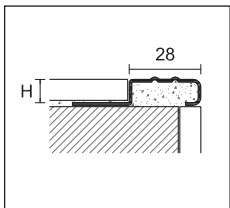

SIS/

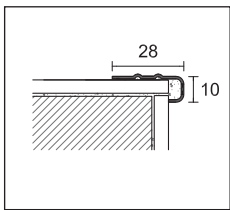

SIS/10/SF



PROSTEP

length = 270 cm - pack 10 pcs

ART.	finishing	10	11	12,5
------	-----------	----	----	------

STAINLESS STEEL

SIS/	brushed stainless steel AISI 304 DIN 1.4301		93987	93989	93988
	euro/m				
SIS/10/SF	brushed stainless steel AISI 304 DIN 1.4301		93997	-	-
	euro/m			-	-

individually packed

Prostep SIX is a stainless steel profile for realization and protection of ceramic, marble and stone steps. They are in accordance with DIN 51131 regulation of non-slip stair nosing thanks to the application of non-slip strips: Safety-Step. It is particularly suitable to protect the stairs in case of high pedestrian traffic.

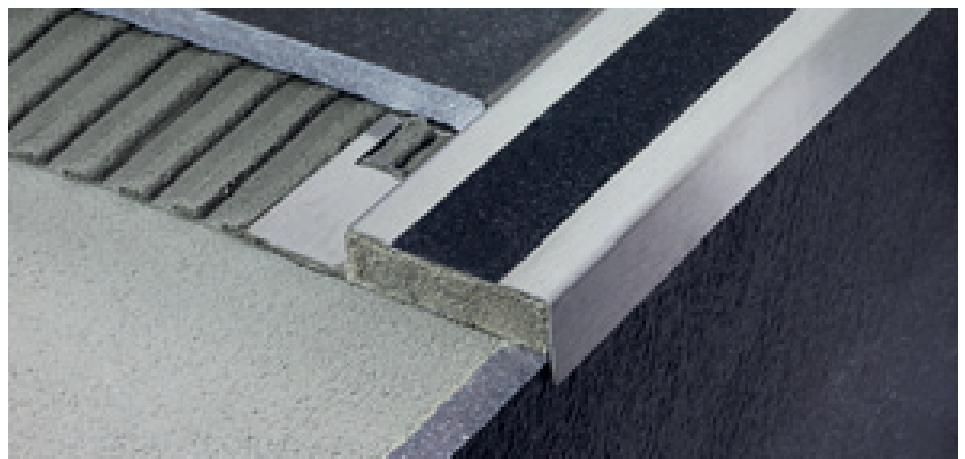

SIX/10 brushed stainless steel AISI 304 - DIN 1.4301 + black slip-resistant 25 mm

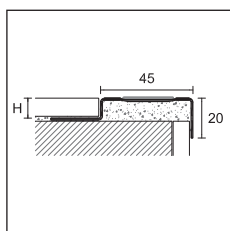

SIX/



PROSTEP

length = 270 cm - pack 10 pcs

ART.	finishing	8	10	12,5
------	-----------	---	----	------

STAINLESS STEEL

SIX/	brushed stainless steel AISI 304 DIN 1.4301 + black slip-resistant 25 mm		93981	93982	93983
	euro/m				

individually packed

Complete the article code with H measure (for example SIS/ for H=10 becomes SIS/10)

stair nosing profiles

cerfix® prostep

Prostep SP is a line of profiles in PVC with aluminium base for realization and protection of ceramic, stone or brick floors. The grooved PVC insert is in accordance with DIN 51131 regulation of non-slip stair nosing.



SP/10 aluminium + Black PVC

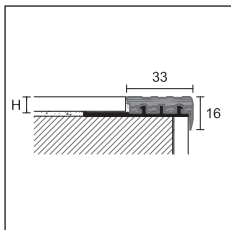

SP/



PROSTEP

length = 270 cm - pack 10 pcs		H		
ART.	finishing	8	10	12,5
SP/	aluminium + black PVC	95200	95210	95220
<i>euro/m</i>				

Prostep SA and SB is a line of profiles in PVC with aluminium base for realization and protection of ceramic, stone or brick floors. The grooved PVC insert is in accordance with DIN 51131 regulation of non-slip stair nosing.



SB/10 aluminium + dark grey PVC

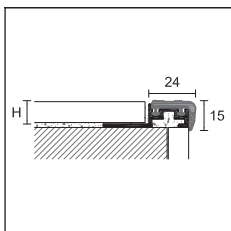

SA/



PROSTEP

length = 270 cm - pack 10 pcs		H			
ART.	finishing	8	10	12,5	15
SA/	aluminium + dark grey PVC	94041	94101	94161	-
<i>euro/m</i>					-

SPARE PVC - pack 10 pcs

SA/G	dark grey PVC	94913		
<i>euro/m</i>				

length = 270 cm - pack 10 pcs		H			
ART.	finishing	8	10	12,5	15

SB/	aluminium + dark grey PVC	94441	94501	94561	94621
<i>euro/m</i>					

SPARE PVC - pack 10 pcs

SB/G	dark grey PVC	94963		
<i>euro/m</i>				

no partial packaging with SA/G and SB/G

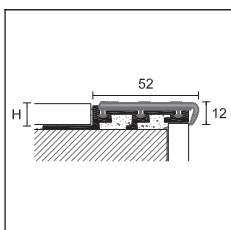

SB/

Complete the article code with H measure
(for example SWA/ for H=10 becomes SWA/10)

Prostep Flex is a line of bendable profiles for the protection of steps or platforms. These profiles can be curved through our Proflex Machine.

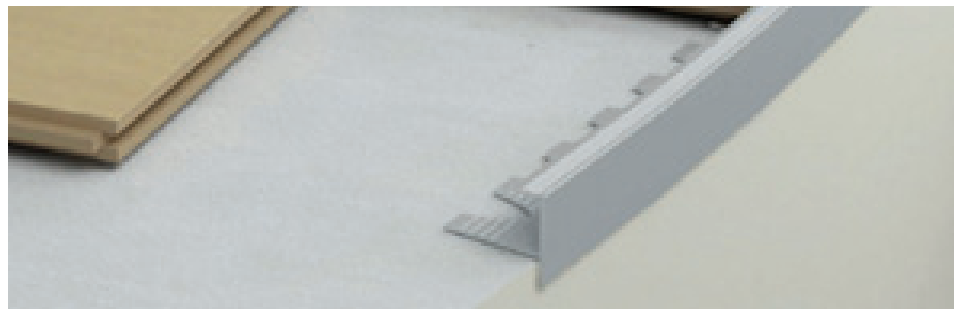

GF/710 silver anodised aluminium

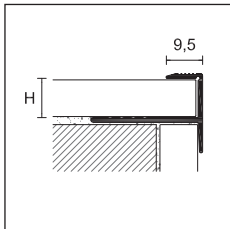

GF/

PRO FLEX LINE



PROSTEP FLEX

length = 270 cm - pack 10 pcs

		H		
ART.	finishing	10	15	
ALUMINIUM		710	715	
GF/	silver anodised		67569	67350
euro/m				

individually packed

Prostep 111 and 75 are anodised aluminium profiles for realization and protection of stairs with low-thickness floors. They are also suitable for LVT floors, provided that they are totally glued.



111/4/F silver anodised aluminium



75/F silver anodised aluminium

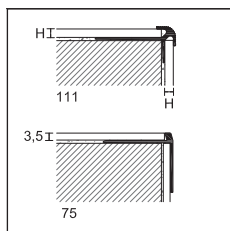

PROTECT

length = 270 cm - pack 20 pcs

		H			
ART.	finishing	2,5	4,5	5	6
ALUMINIUM					
111/ /F	silver anodised		75782	75784	75785
euro/m					

PROTECT

length = 340 cm - pack 20 pcs

		H
ART.	finishing	3,5
ALUMINIUM		
75/F	silver anodised	
euro/m		75388

Complete the article code with H measure (for example SA/ for H=8 becomes SA/8)

protect

Protect 73, 74 and 58 are profiles for protection of step edge in wood, ceramic or marble already laid.

Protec 87, 370 and 373 are in accordance with DIN 51131 regulation of non-slip stair nosing. They are available in version with the holes and self-adhesive.



74/SF silver anodised aluminium

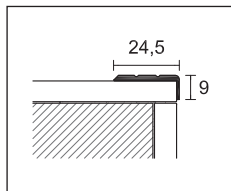

73/

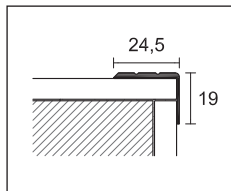

74/

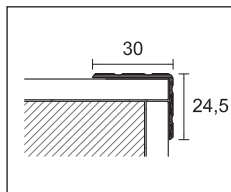

58/

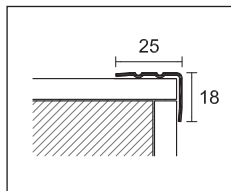

74/IF

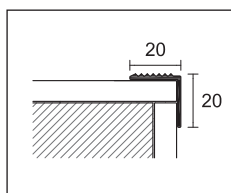

87/
370/

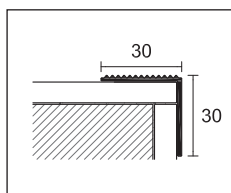

373/

PROTECT

pack		30 pcs	10 pcs / blister				
length cm		270	90	100	-		
ART.		73/	473/			-	
finishing		F SF A	CV	AD	CV	-	
ALUMINIUM							
silver anodised		75208 75209 75238	21422	21434	00337	-	
euro/m			-	-	-	-	
euro/pc		-	-	-	-	-	
gold anodised		75218 - 75248	21423	21435	00338	-	
euro/m		-	-	-	-	-	
euro/pc		-	-	-	-	-	
bronze anodised		- - 75258	-	-	-	-	
euro/m		-	-	-	-	-	
pack		20 pcs	30 pcs	10 pcs / blister		20 pcs	
ART.		58/	74/	474/		74/I	
finishing		A -	F SF A	CV	AD	CV F	
ALUMINIUM							
silver anodised		75900 - 75268 75269 75298	21512	21524	00390	-	
euro/m		-	-	-	-	-	
euro/pc		-	-	-	-	-	
gold anodised		- - 75278 - 75308	21513	21525	00392	-	
euro/m		-	-	-	-	-	
euro/pc		-	-	-	-	-	
bronze anodised		- - - 75318	-	-	-	-	
euro/m		-	-	-	-	-	
titanium anodised		- - - 75299	-	-	-	-	
euro/m		-	-	-	-	-	
length cm							270
STAINLESS STEEL							
brushed stainless steel AISI 304 DIN 1.4301		- - - - -	-	-	-	75275	
euro/m		-	-	-	-	-	

art. 73/, 58/ and 74/ individually packed

PROTECT

pack		30 pcs	10 pcs / blister		
length cm		340	113		
ART.		87/	487/		
finishing		F SF A	CV	AD	
ALUMINIUM					
silver anodised		75108 75109 75138	22615	22641	
euro/m			-	-	
euro/pc		-	-	-	
pack		10 pz	5 pz		
length cm		270	270		
ART.		370/	373/		
finishing		F SF A	F	A	
BRASS					
polished		- 75169 75178	75188	75198	
euro/m		-	-	-	

art. 87/ and 370/ individually packed

Complete the article code with F=drilled, A/AD=adhesive, SF=undrilled, CV=screws (eg. 73/ drilled becomes 73/F)

packaging in blister no partial packaging

Protect 70, 71 and 130 are profiles for protection of step edge in wood, ceramic or marble already laid. They are in accordance with DIN51131 regulation concerning non-slip stair nosing. They are available in the version with holes and self-adhesive and they are particularly suitable for public environments in adaptation to standards.

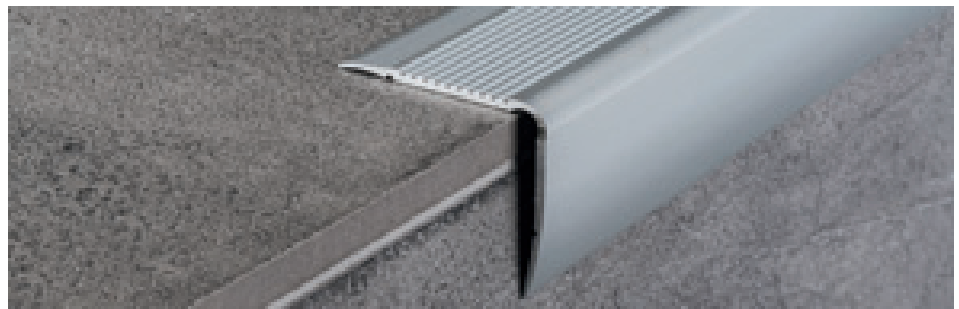

71/SF silver anodised aluminium

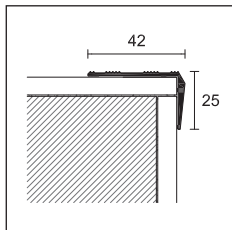

70/

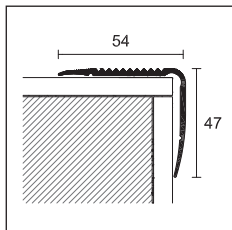

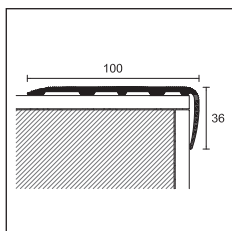

71/



130/

PROTECT

pack	20	10 pcs / blister 	
length cm	340	113	166
ART.	70/	470/	
finishing	F SF A	CV	CV
ALUMINIUM			
silver anodised	 75328 75329 75358	21560	21564
<i>euro/m</i>		-	-
<i>euro/pc</i>	- - -		
gold anodised	 75338 - 75368	-	-
<i>euro/m</i>		-	-

art. 70/ individually packed

PROTECT

pack	10 pcs	8 pcs
length cm	340	270
ART.	71/	130/
finishing	F SF	F SF
ALUMINIUM		
silver anodised	 64067 64066	75804 75805
<i>euro/m</i>		

Complete the article code with F=drilled, A/AD=adhesive, SF=undrilled, CV=with screws (eg. 87/ drilled becomes 87/F) -  packaging in blister no partial packaging

protect

Protect 76, 124, 110, 80 and 126 are anodised aluminium profiles with non-slip Safety-Step inserts or rubber for the protection of already-laid ceramic, wood or carpet steps. Compliant with DIN 51131 regulation regarding non-slip steps, they are available in drilled version and are particularly suitable for public spaces for the adaptation to standards.



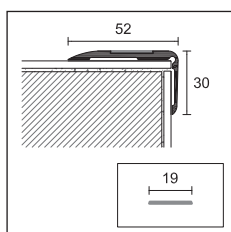

76/F silver anodised aluminium + black slip-resistant insert



76/



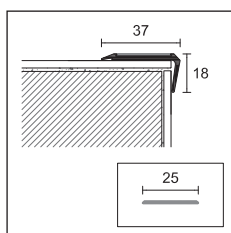

PROTECT

pack	10 pcs	5 pcs / blister 	
length cm	340	113	
ART.	76/	476/	
finishing	F	CV	AD
ALUMINIUM			
silver anodised	 75448	21680	21696
euro/m		-	-
euro/pc	-		
SLIP-RESISTANT ROLL			
length = 1820 cm - width mm		19	
4 rolls pack -			
black		23002	
euro/m			



124/

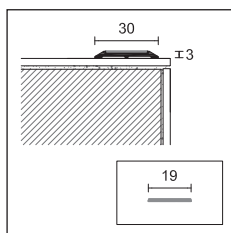

PROTECT

length = 270 cm - pack 24 pcs			
ART.		124/	
finishing		F	
ALUMINIUM			
silver anodised		75794	
euro/m			
SLIP-RESISTANT ROLL			
length = 1820 cm - width mm		25	
4 rolls pack -			
black		23004	
euro/m			



110/

PROTECT

length = 270 cm - pack 24 pcs			
ART.		110/	
finishing		F	
ALUMINIUM			
silver anodised		75780	
euro/m			
SLIP-RESISTANT ROLL			
length = 1820 cm - width mm		19	
4 rolls pack -			
black		23002	
euro/m			

The price per meter of 76/, 124/ and 110/ does not include the non-slip insert that must be ordered separately.

Complete the article code with F=drilled, AD=adhesive, CV=screws (eg. 110/ drilled becomes 110/F)

 packaging in blister no partial packaging



124/F silver anodised aluminium + black slip-resistant insert

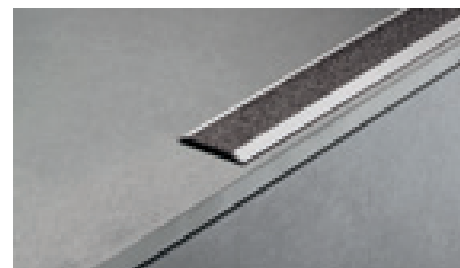

110/F silver anodised aluminium + black slip-resistant insert

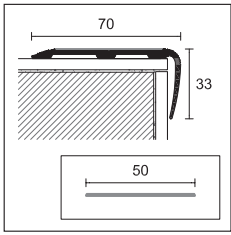

80/



PROTECT

length = 340 cm - pack 10 pcs

ART.	80/
finishing	F

ALUMINIUM

silver anodised		64077
euro/m		

SLIP-RESISTANT ROLL

length = 1820 cm - width mm	50	
2 rolls pack -		
black		23006
euro/m		

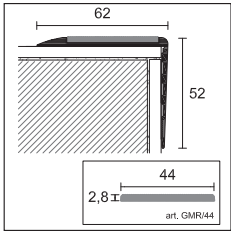

126/

PROTECT

length = 270 cm - pack 6 pcs

ART.	126/
finishing	F

ALUMINIUM

silver anodised		75798
euro/m		

GROOVED RUBBER

length = 1700 cm - 1 rolls pack		
ART.	GMR/44	
black		75706
euro/m		



80/F silver anodised aluminium

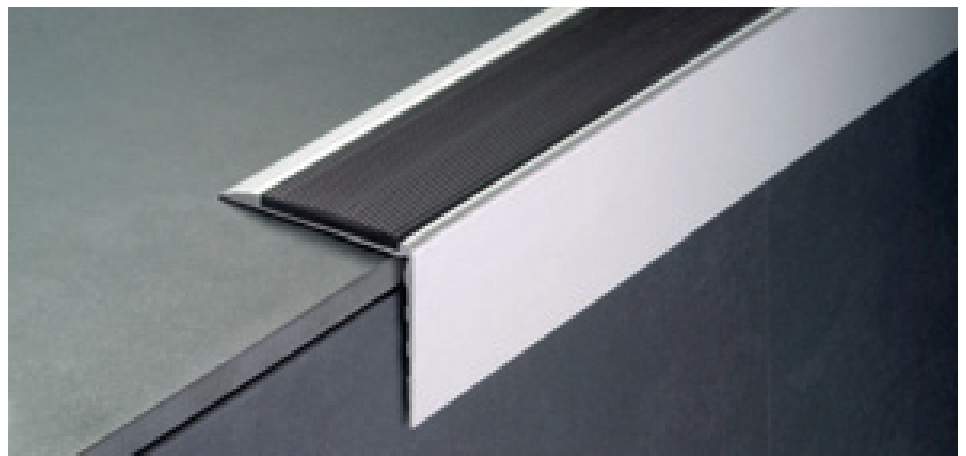

126/F silver anodised aluminium

The price per meter of 80/ does not include the non-slip insert that must be ordered separately.

The price per meter of 126/ does not include the grooved rubber that must be ordered separately.

Complete the article code with F=drilled (for example 80/ drilled becomes 80/F)

stair nosing profiles

protect

Protect 72, 79, 125 and 78 are anodised aluminium profiles with rubber insert replaceable for the protection fo step edge in ceramic, wood, marble and carpet already laid. They are in accordance with DIN 51131 regulation of non-slip stair nosing. They are available in the version with holes and they are particularly suitable for public environments in adaptation to standards.

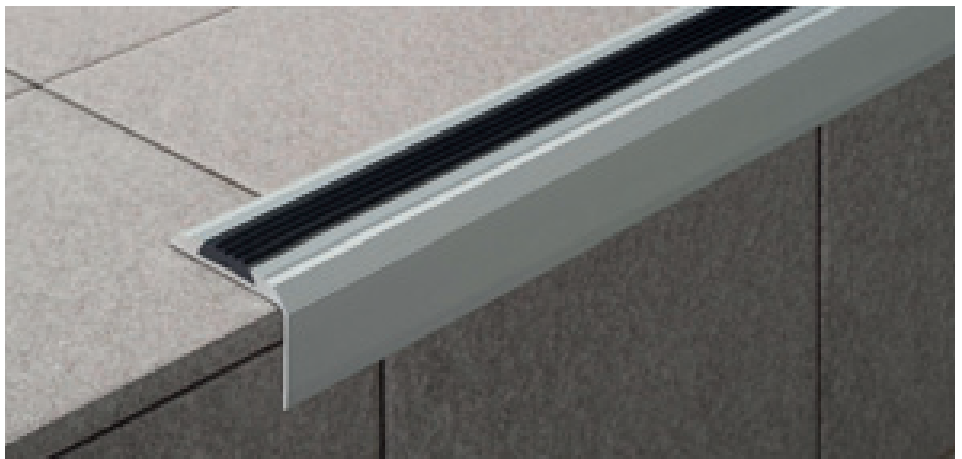

72/F silver anodised aluminium + GM/72 black

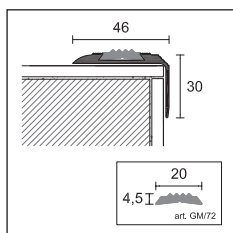

72/



PROTECT

length = 340 cm - pack 10 pcs

ART.	72/
-------------	------------

finishing	F
------------------	----------

ALUMINIUM

silver anodised		75508
euro/m		

gold anodised		75518
euro/m		

GROOVED RUBBER

length = 3400 cm - 2 rolls pack

ART.	GM/72
-------------	--------------

black		75565
euro/m		

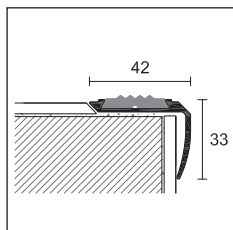

79/F + GM/R

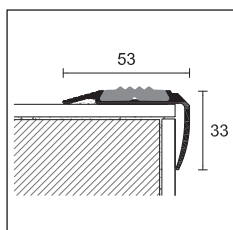

125/F + GM/R

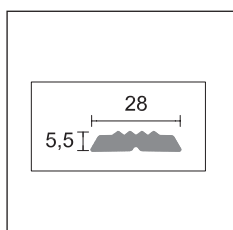

GM/R

PROTECT

pack	10	10
------	----	----

length cm	340	270
-----------	-----	-----

ART.	79/	125/
-------------	------------	-------------

finishing	F	F
------------------	----------	----------

ALUMINIUM

silver anodised		75728	75796
euro/m			

GROOVED RUBBER

length = 3400 cm - 2 rolls pack

ART.	GM/R
-------------	-------------

black		75705
euro/m		

The price per meter of 72/, 79/ and 125/ does not include the grooved rubber that must be ordered separately.

Complete the article code with F=drilled (for example 72/ drilled becomes 72/F)

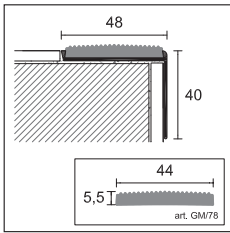

78/



PROTECT

length = 340 cm - pack 20 pcs

ART. **78/**

finishing **F**

ALUMINIUM

silver anodised  75578

euro/m

GROOVED RUBBER

length = 1700 cm - 2 rolls pack

ART. **GM/78**

black  75635

euro/m



125/F silver anodised aluminium + GM/R black

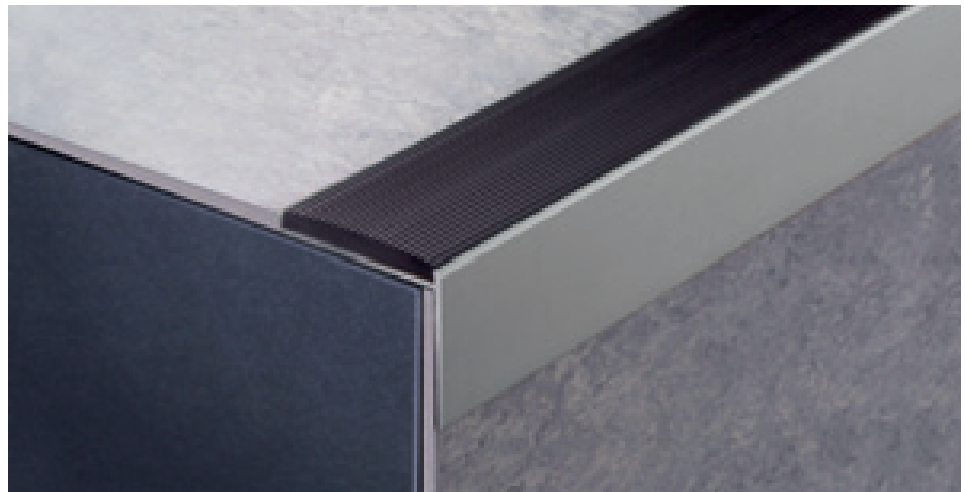

78/F silver anodised aluminium

The price per meter of 78/ does not include the grooved rubber that must be ordered separately.

Complete the article code with F=drilled (for example 78/ drilled becomes 78/F)

protect

Protect 150, 151, 152, 154, 155 and 156 are PVC profiles for the protection of step edge in ceramic, marble, wood, PVC, linoleum, carpet or LVT floors (provided that they are totally glued).

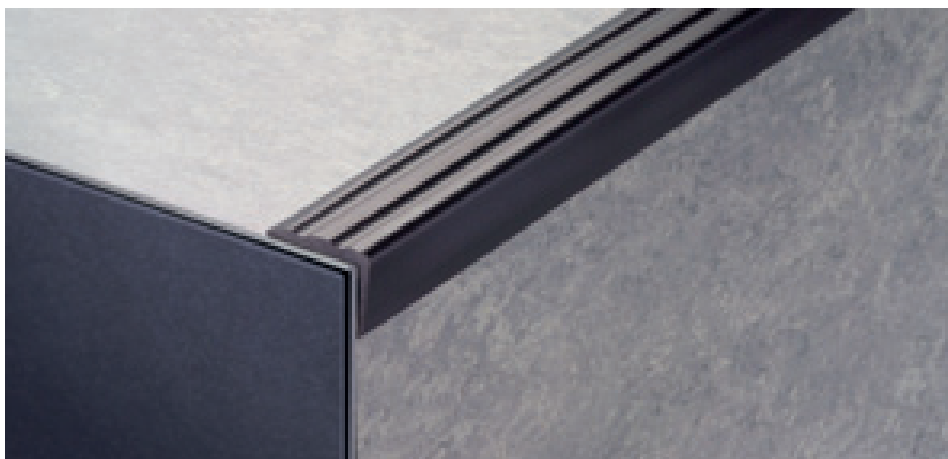

150 Black PVC

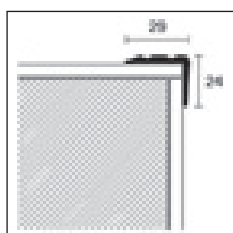

150



PROTECT

length = 300 cm - pack 15 pcs

ART. finishing

PVC

	black		19100
150	grey		19101
	brown		19102
	euro/m		

no partial packaging

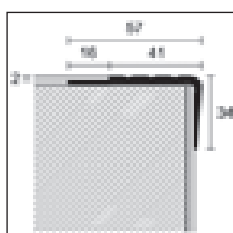

151

PROTECT

length = 300 cm - pack 15 pcs

ART. finishing

PVC

	black		19110
151	grey		19111
	brown		19112
	euro/m		

no partial packaging

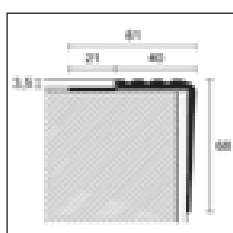

152

PROTECT

length = 300 cm - pack 15 pcs

ART. finishing

PVC

	black		19120
152	grey		19121
	brown		-
	euro/m		

no partial packaging



151 Black PVC

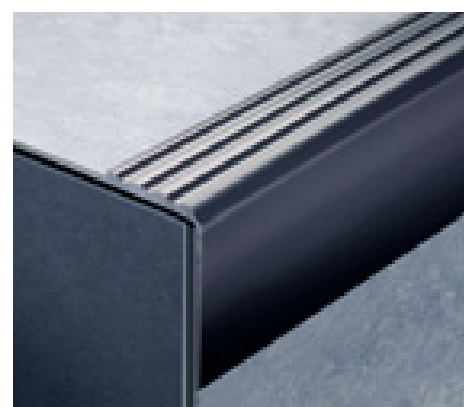

152 Grey PVC

All articles Protect in PVC should be stored horizontally

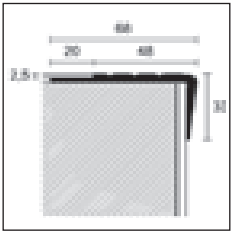

154



PROTECT

length = 300 cm - pack 15 pcs

ART. finishing

PVC

	black		19140
154	grey		19141
	brown		-
	euro/m		

no partial packaging

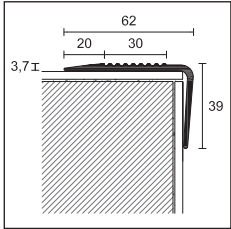

155

PROTECT

length = 300 cm - pack 15 pcs

ART. finishing

PVC

	black		19150
155	grey		19151
	brown		19152
	euro/m		

no partial packaging

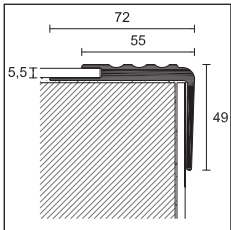

156

PROTECT

length = 300 cm - pack 10 pcs

ART. finishing

PVC

	black		19160
156	grey		19161
	brown		19162
	euro/m		

no partial packaging

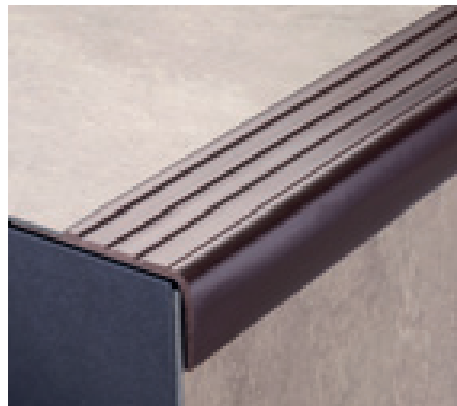

154 Brown PVC



155 Black PVC

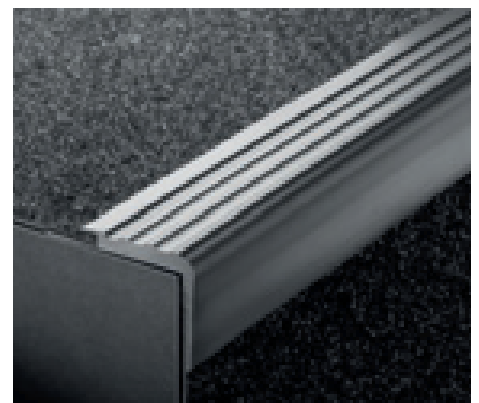

156 Grey PVC

All articles Protect in PVC should be stored horizontally

safety-step



Slip -resistant strips Safety-Step: it is a line of anti-slip adhesive coverings consisting of abrasive particles aggregated by synthetic resins on dimensionally stable support. Suitable for all surfaces subjected to heavy traffic, both pedestrian and vehicular, such as stairs, hall of office and apartment buildings, ramps, walkways, elevators, platforms machinery, emergency exits etc..



Safety-Step - slip-resistant strip



SAFETY-STEP - SLIP-RESISTANT STRIP

colour	width (mm)	length (cm)	code	euro/pc	pack
black	19	61	23000		50
black	25	61	23001		50
black	19	61	23100		10 pcs/ blister 
black	25	61	23101		10 pcs/ blister 
transparent	19	61	23016		50

no partial packaging - one blister contains 4 strips



Safety-Step - slip-resistant strip

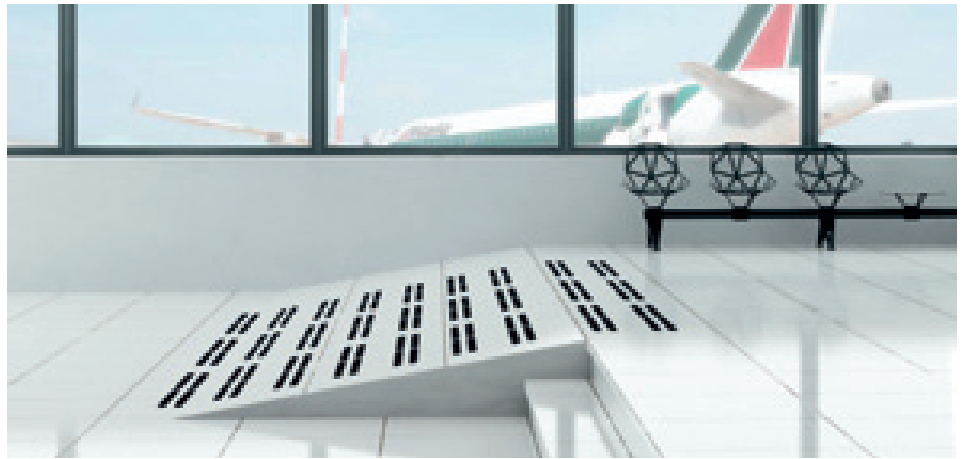

Slip-resistant rolls Safety-Step: it is a line of anti-slip adhesive coverings consisting of abrasive particles aggregated by synthetic resins on dimensionally stable support. Suitable for all surfaces subjected to heavy traffic, both pedestrian and vehicular, such as stairs, hall of office and apartment buildings, ramps, walkways, elevators, platforms machinery, emergency exits etc.. The grey versions (Resilient Medium / Fine) consist of a rubber surface, and are perfect for areas of the walkway also barefoot such as showers, locker rooms, saunas, boats, sports equipment and etc...



Safety-Step - slip-resistant strip



SAFETY-STEP - SLIP-RESISTANT ROLL

colour	width (mm)	length (cm)	code	euro/pc	pack
black	19	1820	23002		4
black	25	1820	23004		4
black	50	1820	23006		2
black	19	360	23103		10 pcs/blister 
black	25	360	23105		10 pcs/blister 
transparent	19	1820	23018		4
transparent	25	1820	23020		4
transparent	50	1820	23022		2
grey	25	1820	23044		4
grey	50	1820	23046		2



Safety-Step - slip-resistant roll

 packaging in blister no partial packaging

prostair

Prostair is a system composed of a profile and its relative accessories for the anchorage of stair rods on steps. The fixing accessories permit a quick removal of the stair rods for cleaning or replacement.

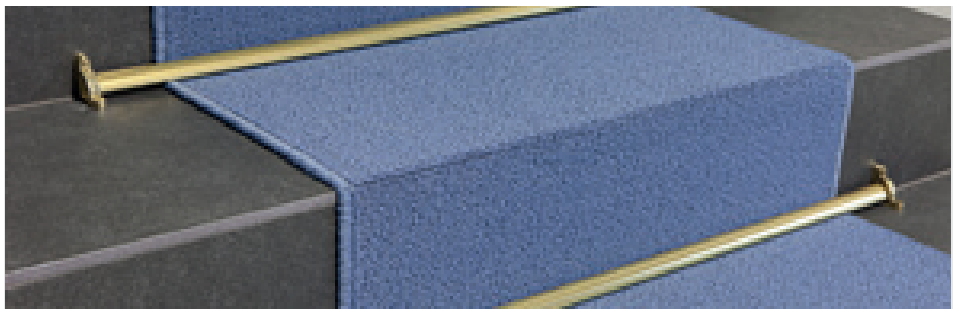

155/16 bright polished gold aluminium + 177/16

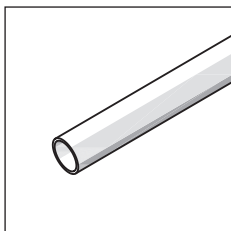

151/11



PROSTAIR

length = 380 cm - diameter 11 - pack 20 pcs

ART. finishing

ALUMINIUM

151/11 bright polished silver  78430
euro/m

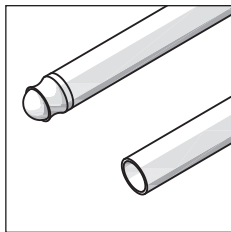

150/

PROSTAIR

pack 20 pcs

length cm	80	90	100	120	380
-----------	----	----	-----	-----	-----

ART. finishing

ALUMINIUM

		diameter				
	11	78311	78312	78313	78314	78319
	euro/pc					-
	euro/m	-	-	-	-	
150/	13	78321	-	78323	-	78329
	euro/pc					-
	euro/m	-	-	-	-	
	16	-	-	-	-	78339
	euro/m	-	-	-	-	

pack 10 pcs / blister 

4150/11/S	bright polished gold		11	21810	21811	21812	-	-
	euro/blister						-	-

articles 150/11, 150/13 and 150/16 of 380 cm partial packaging available and without knobs, for other articles no partial packaging - article 150/13 of 380 cm pack 40 pcs - article 150/16 of 380 cm pack 25 pcs

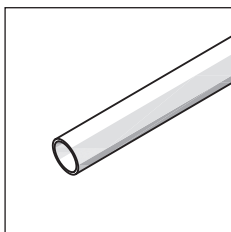

163/

PROSTAIR

pack	10 pcs	10 pcs	10 pcs		
length = 380 cm					
finishing					
BRASS	diameter				
	11	13	16		
163/	polished		78801	78802	78803
	euro/m				

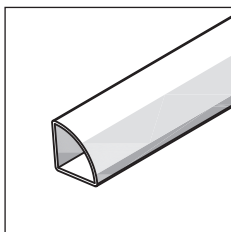

155/16

OTHER PROFILES

length = 300 cm - pack 20 pcs

ART. finishing 16x16

ALUMINIUM

155/16 bright polished gold  78379
euro/m

art. 163/ available in different lengths on request, extra €/pc

Complete the article code with the diameter measure (for example 150/ for diameter=11 becomes 150/11)

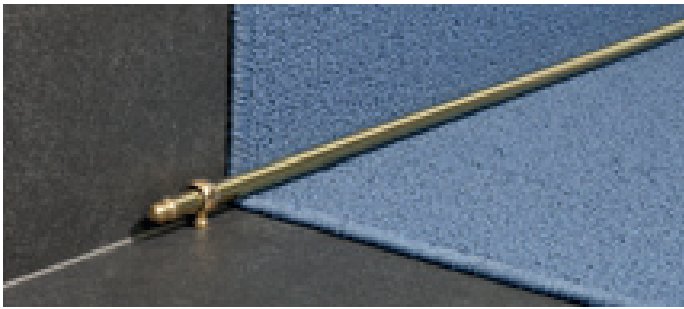

163/13 polished brass + 170/13



155/16 bright polished gold aluminium + 168/16 + 178/16

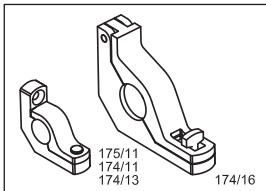

175/11 + 174/13

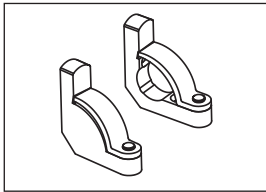

177/16

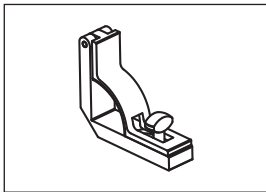

178/16

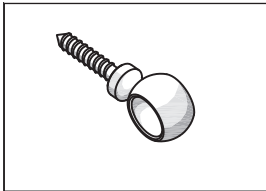

171/ + 170/

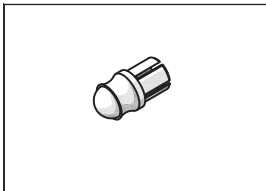

161/11 + 169/

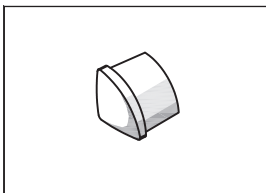

168/16

ACCESSORIES - BRACKETS

pack 20 pcs		diameter		
ART.	finishing	11	13	16
BRASS				
175/11	chromium plated	78445	-	-
	<i>euro/pc</i>		-	-
pack 20 pcs				
174/	polished	78410	-	78412
	<i>euro/pc</i>		-	-
pack 10 couples 2 pcs dx/sx				
177/16	polished	-	-	78415
	<i>euro/couple</i>	-	-	-
pack 20 pcs		measures		
		16x16		
178/16	polished	78420		
	<i>euro/pc</i>			

ACCESSORIES - RINGS

pack 20 pcs		diameter		
ART.	finishing	11	13	16
BRASS				
171/11	chromium plated	78440	-	-
	<i>euro/pc</i>		-	-
pack 20 pcs				
170/	polished	78400	78401	78402
	<i>euro/pc</i>			
10 blister packs/ 4 pcs/blister				
4170/ /S	polished	21852	-	-
	<i>euro/blister</i>		-	-
no partial packaging				

ACCESSORIES - KNOBS

pack 20 pcs		diameter		
ART.	finishing	11	13	16
BRASS				
161/11	chromium plated	78435	-	-
	<i>euro/pc</i>		-	-
pack 20 pcs				
169/	brass (for aluminium and brass profiles)	78395	78396	78397
	<i>euro/pc</i>			
pack 20 pcs		16x16		
168/16	polished	78418		
	<i>euro/pc</i>			
no partial packaging				

Complete the article code with diameter measure (eg. 174/ for diameter=11 becomes 174/11)





profiles for wooden, laminare and LVT floors

A full range of profiles for wooden, laminate and LVT floors (glue-down, loose-lay and click). A series of systems and professional solutions proposed in different colours of anodised aluminium and in the exclusive finishes Alcrom® Plus, with the possibility of further customization thanks to PDS technology.

profiles for wooden and laminate floors

unisystem plus



Unisystem Plus is a system for the floating installation of wooden and laminate floors from 6,5 to 22,6 mm thickness. Composed of connection profiles for same and different level floors, perimetral profiles and stair nosing profiles, Unisystem Plus is easy to lay and simple to remove. The system is composed of a top profile, an aluminium base and a fixing clip: after inserting the fixing clip in the top profile, just push the top profile to fix it to the aluminium base.

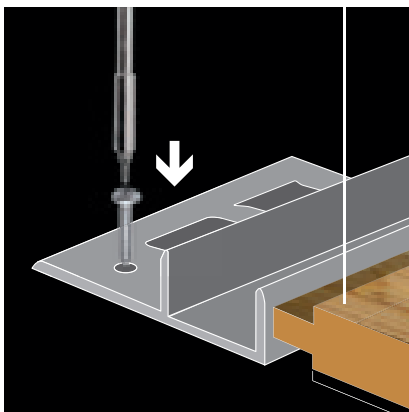

fix the aluminium base to the subfloor with screws or glue

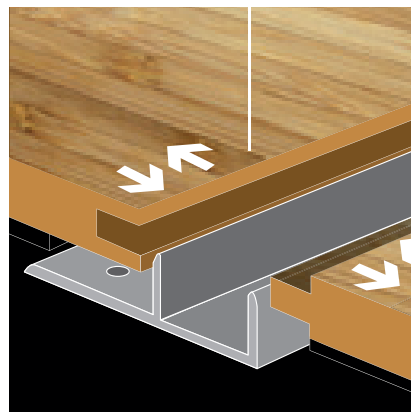

bring the floor planks closer

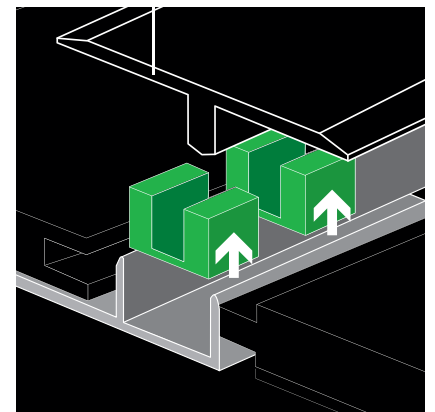

insert the clips in the top profile

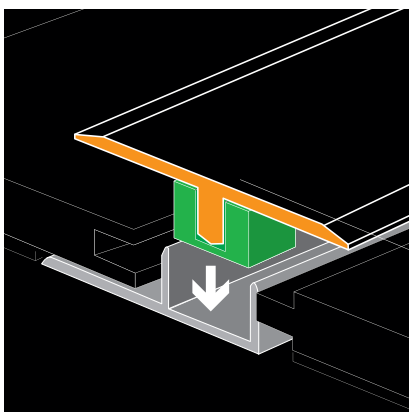

put the top profile in the base

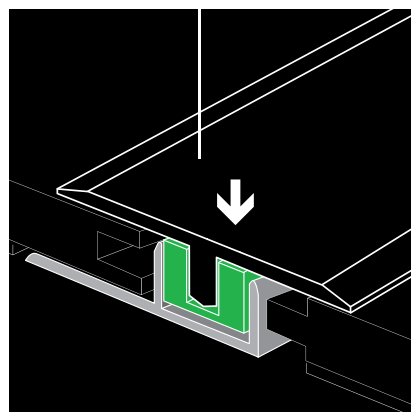

push the top profile in the base

Unisystem Plus line

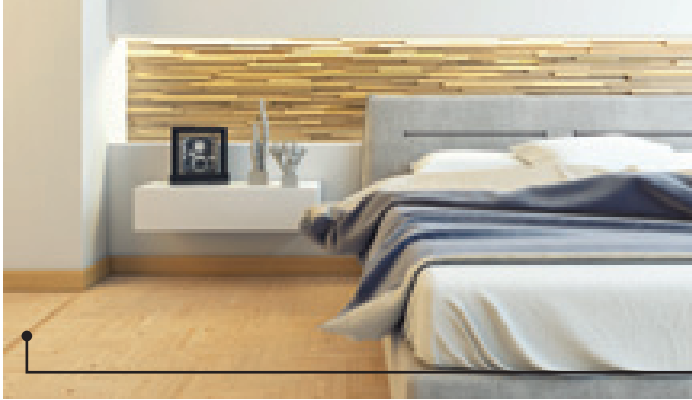

Connection profiles for floors of same level

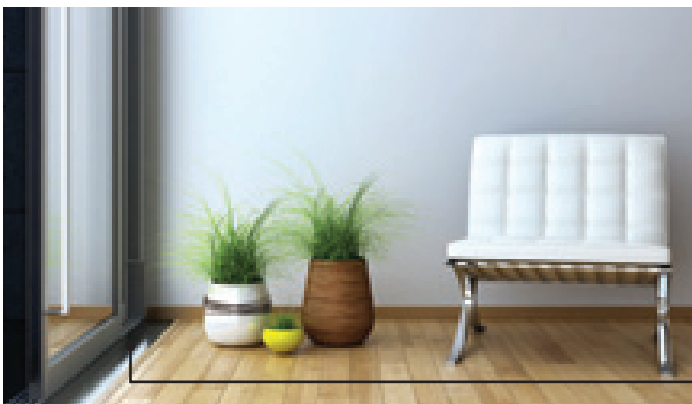

Connection profiles for floors of different level



Perimetral profiles

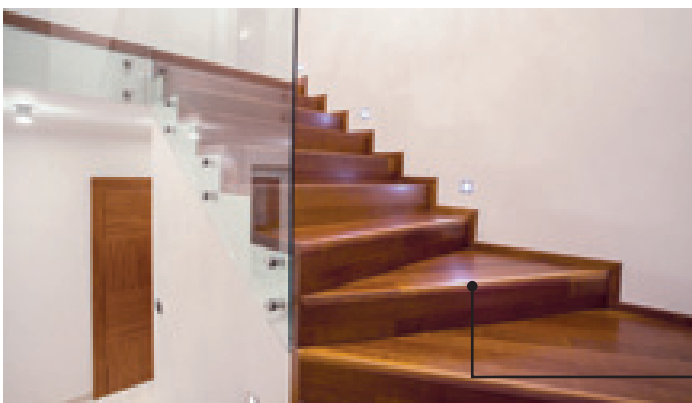

Stair nosing profiles



unisystem - unisystem plus

Unisystem Plus is a system for the floating installation of wooden and laminate floors from 6,5 to 22,6 mm thickness, composed of junction profiles for same level floors (Z/ series), connection profiles for different level floors (C/ series) and perimetral profiles (S/ series). The system is composed of a natural aluminium base and a top profile to be fixed on the base through a specific clip. The top profile is available in different finishes of anodised aluminium or covered with wood-effect Alcrom® Plus film for matching the floor perfectly.



Unisystem Plus S/9/SF, Z/1/SF and C/7/SF

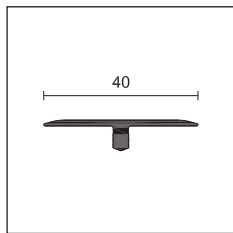

Z/1/SF

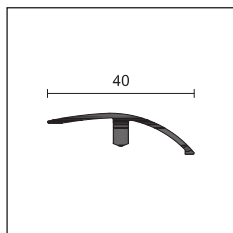

C/7/SF

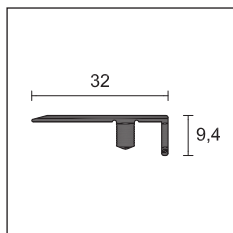

S/9/SF



UNISYSTEM PLUS

length = 270 cm - pack 10 pcs

ART.	finishing	Z/1/SF	C/7/SF	S/9/SF
floor thickness from / to mm		6,5/22,6	6,5/10	6,5/22,6

ALUMINIUM covered with ALCROM® PLUS film

02	66301	66001	65701
05	66306	66006	65706
08	66304	66004	65704
10	66307	66007	65707
11	66308	66008	65708
12	66309	66009	65709
13	66310	66010	65710
14	66311	66011	65711
18	66316	66016	65716
19	66318	66018	65718
20	66317	66017	65717
26	66321	66021	65721
31	66328	66028	65728
32	66329	66029	65729
34	66331	66031	65731
35	66332	66032	65732
36	66333	66033	65733
37	66334	66034	65734
38	66335	66035	65735
39	66336	66036	65736
40	66337	66037	65737
41	66338	66038	65738
42	66339	66039	65739
43	66340	66040	65740
44	66341	66041	65741
47	66344	66044	65744
65	66365	66065	65765
71	66368	66068	65768
72	66369	66069	65769
73	66370	66070	65770
74	66371	66071	65771
76	66374	66074	65774
77	66372	66072	65772
78	66376	66076	65776
79	66373	66073	65773
80	66377	66077	65777
81	66378	66078	65778
89	66386	66086	65784

euro/m

individually packed

UNISYSTEM PLUS

length = 270 cm - pack 10 pcs

ART.	finishing	Z/1/SF	C/7/SF	S/9/SF
floor thickness from / to mm		6,5/22,6	6,5/10	6,5/22,6

ALUMINIUM covered with ALCROM® PLUS film

91	66388	66088	65786
92	66389	66089	65789
93	66390	66090	65790
94	66391	66091	65791
95	66392	66092	65792
351	66393	66093	-
363	66394	66094	-
372	66395	66095	-
490	66397	66097	-
560	66398	66098	-
580	66399	66099	65793
590	66400	66100	-
665	66401	66101	65794
670	66402	66102	65795
951	66408	66108	65797
975	66409	66109	65798
1024	66410	66110	65799
1033	66411	66111	65800
1042	66412	66112	65801
1090	66414	66114	65803
1202	66416	66116	65805
1203	66417	66117	65806
1204	66418	66118	65807
1205	66419	66119	65808
1206	66420	66120	65809
1207	66421	66121	65810
1208	66422	66122	65811
1209	66423	66123	65812
1210	66424	66124	65813
1211	66425	66125	65814
1212	66426	66126	65815
1213	66427	66127	65816
1214	66428	66128	65817
1215	66429	66129	65818
1216	66430	66130	65819
1217	66431	66131	65820
100	66432	66132	-
black 97	66433	66133	65821

euro/m

individually packed

Profiles of 270 cm length: please order the base separately.

Customized PDS decors on request, see page 191



UNISYSTEM PLUS

length = 270 cm - pack 20 pcs

ART.	finishing	Z/1/SF	C/7/SF	S/9/SF
		6,5/22,6	6,5/10	6,5/22,6

ANODISED ALUMINIUM

silver		67217	67007	65680
--------	--	-------	-------	-------

euro/m

titanium		67238	67000	65691
----------	--	-------	-------	-------

gold		67227	67017	65685
------	--	-------	-------	-------

gold sand		67234	67024	65688
-----------	--	-------	-------	-------

bronze		67237	67027	65690
--------	--	-------	-------	-------

euro/m

Other models for thicker floors available on page 172 individually packed

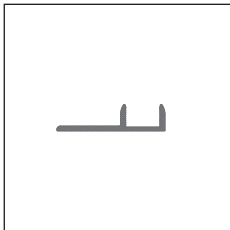

TPU/

UNISYSTEM PLUS - BASES

floor thickness from / to mm	6,5/10	9,6/12,5	12,6/15,5	15/19	19,6/22,6
------------------------------	--------	----------	-----------	-------	-----------

length = 270 cm
pack 20 pcs (15 clips TU/6 included)

ART.	finishing	6	10	13	15	22

ALUMINIUM

TPU/	natural aluminium		67437	67447	67457	67460	67467
------	-------------------	--	-------	-------	-------	-------	-------

euro/m

individually packed (art. TPU/22 pack 10 pcs)

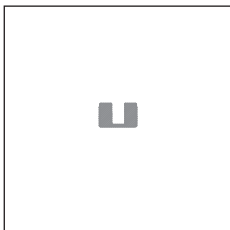

TU/6

SPARE CLIPS

pack of 150 pcs

	H
--	---

TU/6	68812/150
------	-----------

euro/pack

no partial packaging

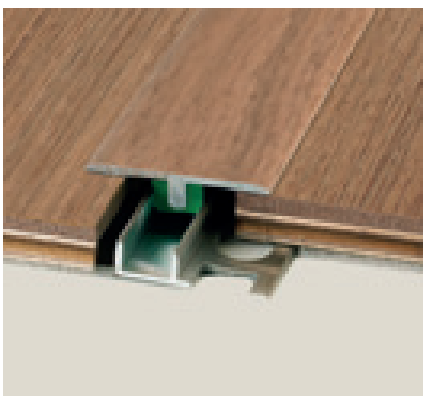

Z/1/SF aluminium covered with Alchrom® Plus film



C/7/SF aluminium covered with Alchrom® Plus film

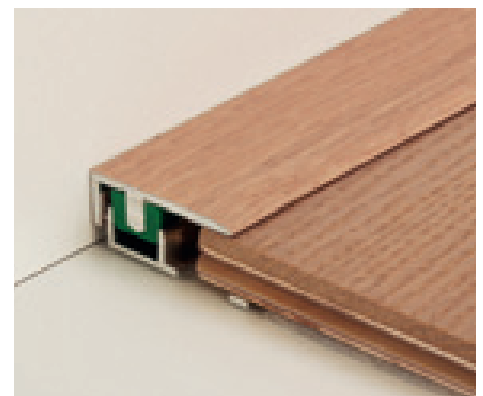

S/9/SF aluminium covered with Alchrom® Plus film

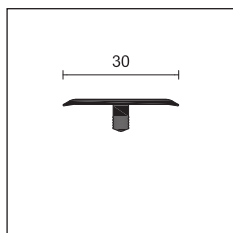

Z3/30/SF



UNISYSTEM PLUS

length = 270 cm	pack 20 pcs	pack 20 pcs	pack 10 pcs	pack 10 pcs	pack 10 pcs	
ART.	finishing	Z3/30/SF	C/10/SF	C/13/SF	C/22/SF	S/15/SF
floor thickness from / to mm		6,5/22,6	9,6/12,5	12,6/15,5	15/22,6	9,6/22,6

ANODISED ALUMINIUM

silver		63700	67077	67147	66907	65480
euro/m						
gold		63702	67087	67157	-	-
gold sand		63704	-	-	-	65488
euro/m						

individually packed

UNISYSTEM PLUS - BASES

floor thickness from / to mm 6,5/10 9,6/12,5 12,6/15,5 15/19 19,6/22,6

length = 270 cm	H				
pack 20 pcs (15 clips TU/6 included)	6	10	13	15	22

ART.	finishing	6	10	13	15	22
------	-----------	---	----	----	----	----

ALUMINIUM

TPU/	natural aluminium		67437	67447	67457	67460	67467
euro/m							

individually packed (art. TPU/22 pack 10 pcs)

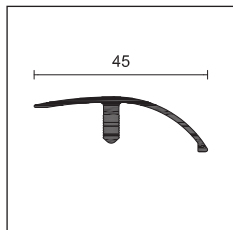

C/10/SF

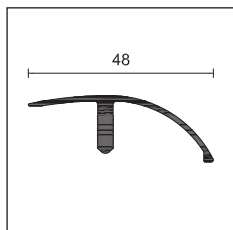

C/13/SF

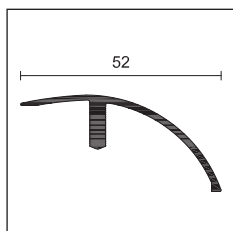

C/22/SF

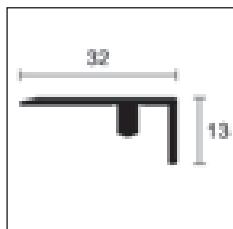

S/15/SF

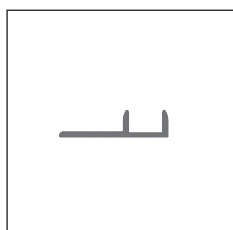

TPU/

SPARE CLIPS

pack da 150 pcs	H
	6

TU/6	68812/150
-------------	-----------

euro/pack

no partial packaging



unisystem - unisystem plus

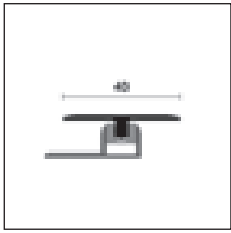

TPZ/

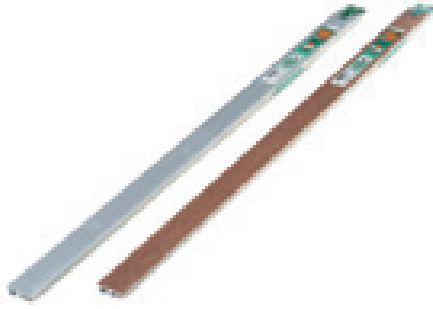

TPZ/47/CV silver anodised aluminium and aluminium covered with Alcrom® Plus film

UNISYSTEM PLUS

length = 90 cm - pack 10 pcs / blister - for floor thicknesses from 6,5 to 10 mm

ART. finishing

ALUMINIUM covered with ALCROM® PLUS film

	05	43005		77	43011		1208	43027
	10	43020		78	43066		1209	43029
	14	43006		80	43068		1210	43030
	19	43007		89	43012		1211	43031
	20	43028		91	43013		1212	43033
TPZ/47/CV	26	43008		580	43014		1213	43035
	31	43009		1202	43016		1214	43037
	38	43034		1203	43017		1215	43039
	39	43010		1204	43018		1216	43041
	40	43036		1205	43019		1217	43043
	42	43038		1206	43025			
	65	43056		1207	43026			

euro/pc

individually packed

UNISYSTEM PLUS

length = 90 cm - pack 10 pcs / blister

ART. finishing

ANODISED ALUMINIUM

ART.	finishing	TPZ/47/CV	TPZ/410/CV	TPZ/413/CV
	floor thickness from / to mm	6,5 / 10	9,6 / 12,5	12,6 / 15,5
	silver	43000	43072	43144
	gold	43004	43076	43148

euro/pc

individually packed - gold anodised extra euro/pc + 0,57

UNISYSTEM PLUS

length = 90 cm - pack 10 pcs / blister - for floor thicknesses from 6,5 to 10 mm

ART. finishing

ALUMINIUM covered with ALCROM® PLUS film

	05	43219		77	43225		1208	43239
	10	43234		78	43280		1209	43240
	14	43220		80	43282		1210	43241
	19	43221		89	43226		1211	43243
	20	43242		91	43227		1212	43244
TPC/47/CV	26	43222		580	43228		1213	43245
	31	43223		1202	43231		1214	43247
	38	43248		1203	43232		1215	43249
	39	43224		1204	43233		1216	43251
	40	43250		1205	43235		1217	43253
	42	43252		1206	43236			
	65	43270		1207	43237			

euro/pc

individually packed

UNISYSTEM PLUS

length = 90 cm - pack 10 pcs / blister

ART. finishing

ANODISED ALUMINIUM

ART.	finishing	TPC/47/CV	TPC/410/CV	TPC/413/CV
	floor thickness from / to mm	6,5 / 10	9,6 / 12,5	12,6 / 15,5
	silver	43214	43286	43358
	gold	43218	43290	43362

euro/pc

individually packed - gold anodised extra euro/pc + 0,57

UNISYSTEM PLUS

length = 90 cm - pack 10 pcs / blister

ART. finishing

ANODISED ALUMINIUM

ART.	finishing	TPS/47/CV	TPS/410/CV	TPS/413/CV
	floor thickness from / to mm	6,5 / 10	9,6 / 12,5	12,6 / 15,5
	silver	43430	43502	43574

euro/pc

individually packed

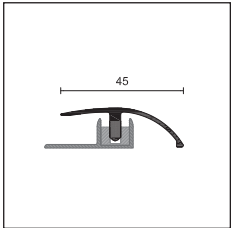

TPC/

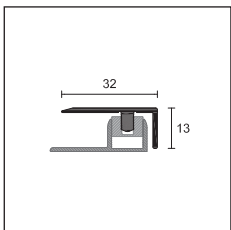

TPS/

The blister pack contains base, clips and profile.

unisystem plus

G/2/SF is a stair nosing profile of Unisystem Plus line. Composed of a base and a top profile, it is suitable for the installation of floating wooden and laminate with thicknesses from 6,5 to 12,5 mm.

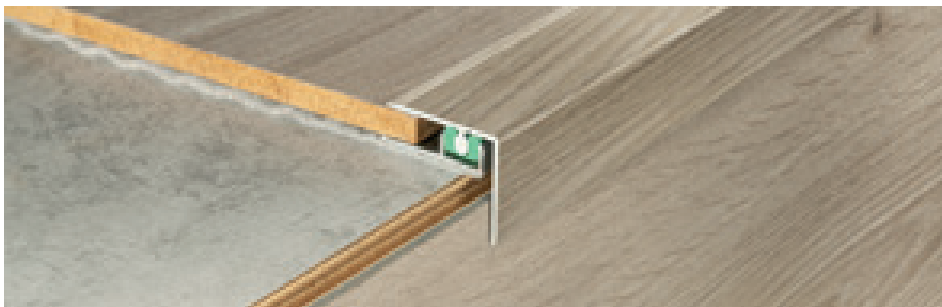

G/2/SF aluminium covered with Alcrom® Plus film

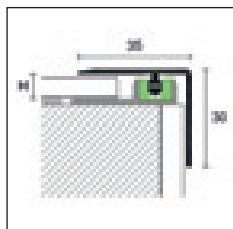

G/2/SF + TPU/



UNISYSTEM PLUS

length = 270 cm - pack 10 pcs - for floor thicknesses from 6,5 to 12,5 mm

ART. finishing

ALUMINIUM covered with ALCROM® PLUS film

	05	43645		41	43656		1207	43668
	08	43646		77	43657		1208	43669
	12	43647		89	43658		1209	43670
	13	43648		91	43659		1210	43671
	14	43649		93	43660		1211	43672
G/2/SF	19	43650		580	43661		1212	43673
	26	43651		1202	43663		1213	43674
	32	43652		1203	43664		1214	43675
	36	43653		1204	43665		1215	43676
	39	43654		1205	43666		1216	43677
	40	43655		1206	43667		1217	43678

euro/m

individually packed

UNISYSTEM PLUS

length = 270 cm - pack 10 pcs - for floor thicknesses from 6,5 to 12,5 mm

ART. finishing

ANODISED ALUMINIUM

	silver			43690
G/2/SF	euro/m			
	titanium			43691
	euro/m			

individually packed

UNISYSTEM PLUS - BASES

floor thickness from / to mm 6,5/10 9,6/12,5

length = 270 cm - pack 20 pcs (15 clips TU/6 included)

ART. finishing 6 10 H

ALUMINIUM

TPU/	natural aluminium		67437	67447
	euro/m			

individually packed

SPARE CLIPS

pack 150 pcs H

6

TU/6 68812/150

euro/pack

no partial packaging

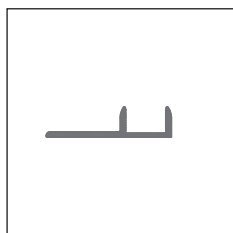

TPU/

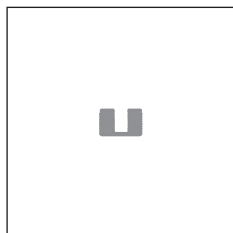

TU/6

Customized PDS decors on request, see page 191

Profiles of 270 cm length: please order the base separately.

G/4/SF is a stair nosing profile of Unisystem Plus range, composed of a base and a top profile, for the floating installation of wooden and laminate floors with thicknesses from 6,5 to 15,5 mm.



G/4/SF aluminium covered with Alcrom® Plus film

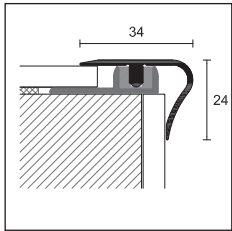

G/4/SF + TPU/



UNISYSTEM PLUS

length = 270 cm - pack 10 pcs - for floor thicknesses from 6,5 to 15,5 mm

ART. finishing

ALUMINIUM covered with ALCROM® PLUS film

G/4/SF	02	63905	37	63943	76	63956
	08	63907	38	63919	77	63937
	10	63910	40	63920	78	63934
	11	63911	41	63926	79	63938
	12	63913	42	63921	80	63935
	13	63916	43	63927	81	63939
	18	63914	44	63929	92	63941
	20	63915	65	63931	93	63944
	32	63917	71	63951	94	63945
	34	63923	72	63952	95	63946
	35	63924	73	63953		
	36	63942	74	63954		

euro/m

individually packed

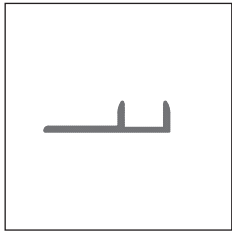

TPU/

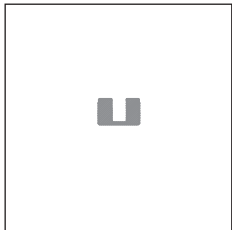

TU/6

UNISYSTEM PLUS

length = 270 cm - pack 10 pcs - for floor thicknesses from 6,5 to 15,5 mm

ART. finishing

ANODISED ALUMINIUM

G/4/SF	silver		63900
	euro/m		
	gold sand		63904
	euro/m		

individually packed

UNISYSTEM PLUS - BASES

floor thickness from / to mm	6,5/10	9,6/12,5	12,6/15,5
length = 270 cm pack 20 pcs (15 clips TU/6 included)		H	
ART. finishing	6	10	13
ALUMINIUM			
TPU/ natural aluminium	67437	67447	67457
euro/m			

individually packed

SPARE CLIPS

pack da 150 pcs	H
	6
TU/6	68812/150

euro/pack

no partial packaging

Profiles of 270 cm length: please order the base separately.

Customized PDS decors on request, see page 191

profix thin

Profix Thin is a system designed to allow the expansion of Click LVT floors, also suitable for loose-lay LVT floors. Profix Thin is suitable for floors from 4 to 8 mm thick and is composed of junction profiles for same level floors (Z/4), connection profiles for different level floors (C/4) and perimetral profiles (S/4). The system is composed of PVC base and a top profile available in different finishes of anodised aluminium or covered with wood-, stone- or concrete-effect Alcrom® Plus film for matching the floor perfectly.

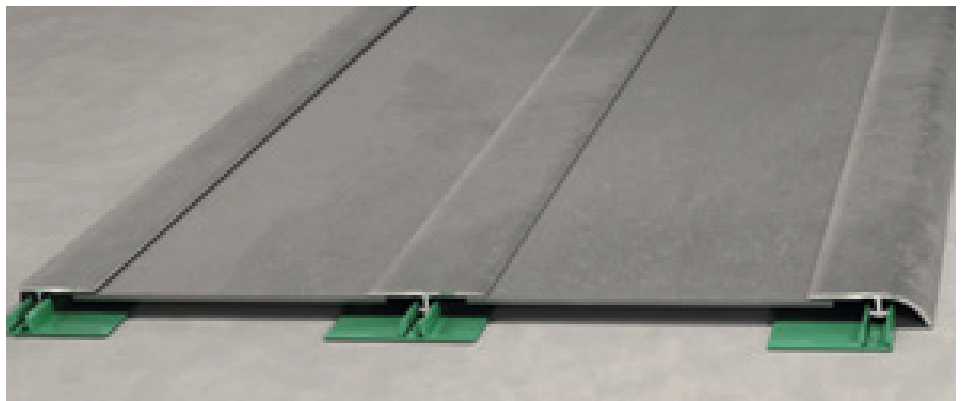

Profix Thin S/4, Z/4 and C/4

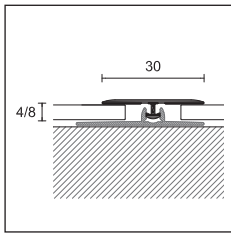

Z/4 + PT/4

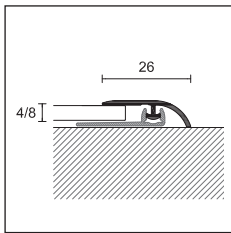

C/4 + PT/4/SA

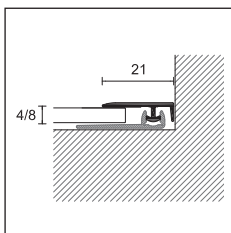

S/4 + PT/4/SA

PROFIX THIN

length = 270 cm - pack 20 pcs

for floor thickness (from 4 to 8 mm)

ALUMINIUM covered with ALCROM® PLUS film

	Z/4	C/4	S/4
1003	85101	85201	85301
1006	85102	85202	85302
1009	85103	85203	85303
1012	85104	85204	85304
1021	85107	85207	85307
1024	85108	85208	85308
1030	85110	85210	85310
1033	85111	85211	85311
1036	85112	85212	85312
1042	85114	85214	85314
1045	85115	85215	85315
1051	85117	85217	85317
1054	85118	85218	85318
1057	85119	85219	85319
1060	85120	85220	85320
1063	85121	85221	85321
1066	85122	85222	85322
1069	85123	85223	85323
1081	85127	85227	85327
1084	85128	85228	85328
1090	85130	85230	85330
1105	85135	85235	85335
1108	85136	85236	85336
1111	85137	85237	85337





euro/m

individually packed

PROFIX THIN

length = 270 cm - pack 20 pcs

for floor thickness (from 4 to 8 mm)

ART.	Z/4	C/4	S/4
finishing			
ANODISED ALUMINIUM			
silver	 85050	85060	85070
euro/m			
gold sand	 85052	85062	85072
titanium	 85054	85064	85074
euro/m			
bronze elox	 85056	85066	85076
euro/m			

Customized PDS decors on request, see page 191

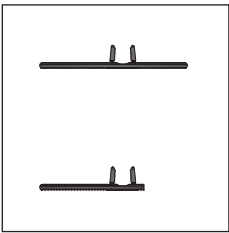

PT/4
PT/4/SA

PROFIX THIN - BASES

length = 270 cm - pack 20 pcs

for floor thickness (from 4 to 6 mm)

ART.	PT/4	PT/4/SA
finishing		
PVC		
green		85081
<i>euro/m</i>		85083

To order PT/4 and PT/4/SA in pack of 100 pcs mark /100 after the article code (for example code 85081 becomes 85081/100). Pack of 100 pcs of PT/4 and PT/4/SA €/m

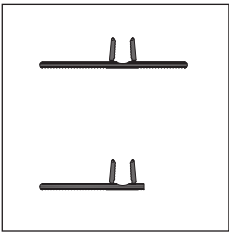

PT/6
PT/6/SA

PROFIX THIN - BASES

length = 270 cm - pack 20 pcs

for floor thickness (from 6 to 8 mm)

ART.	PT/6	PT/6/SA
finishing		
PVC		
green		85086
<i>euro/m</i>		85088

To order PT/6 and PT/6/SA in pack of 100 pcs mark /100 after the article code (for example code 85086 becomes 85086/100). Pack of 100 pcs of PT/6 and PT/6/SA €/m

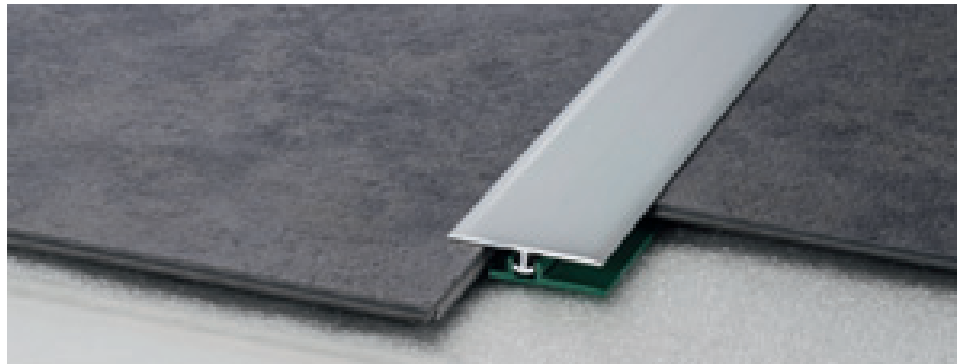

Z/4 + PT/4

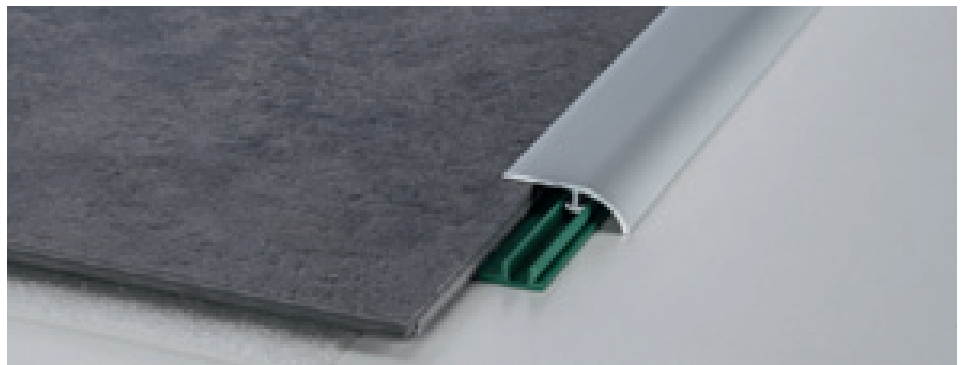

C/4 + PT/4/SA

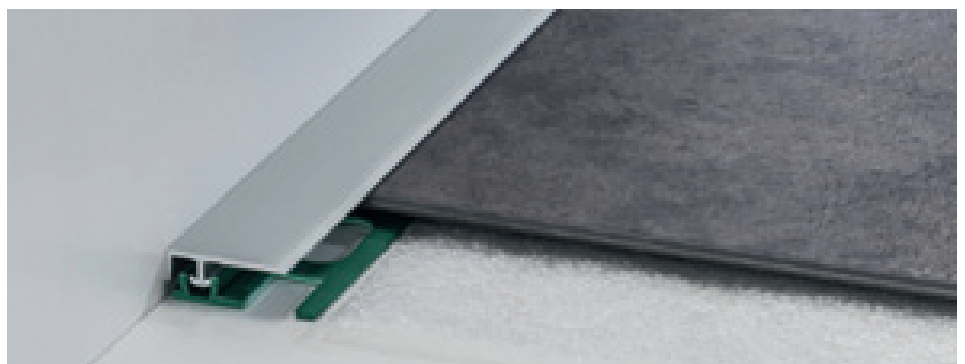

S/4 + PT/4/SA

prestowood

Prestowood 22/A, 50/A and 63/A are adhesive profiles for wooden floors of same level, different level and stairs that have been already installed. In anodised aluminium, or covered with Alcrom® Plus film, they are particularly easy and quick to install, thus becoming suitable also for the DIY.



22/A aluminium covered with Alcrom® Plus film

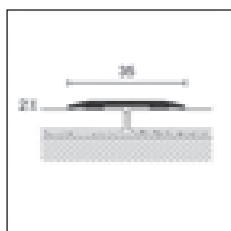

422/AD
22/A

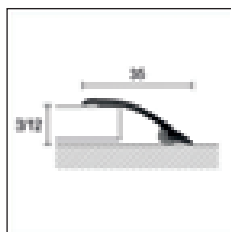

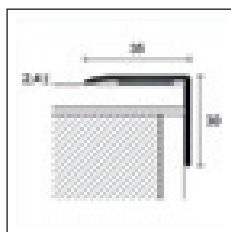

450/AD
50/A









































63/A



PRESTOWOOD

pack	10 pcs / blister 	10 pcs	10 pcs / blister 	10 pcs	10 pcs
length cm	90	270	90	270	270
ART.	422/AD	22/A	450/AD	50/A	63/A

ALUMINIUM covered with ALCROM® PLUS film

	05	43700	43932	44949	45031	45140
	08	43701	43933	44950	45032	45141
	12	43702	43934	44951	45033	45142
	13	43703	43935	44952	45034	45143
	14	43704	43936	44953	45035	45144
	19	43705	43937	44954	45036	45145
	26	43706	43938	44955	45037	45146
	31	43707	43939	44956	45038	-
	32	43708	43940	44957	45039	45147
	34	43709	43941	44958	45040	-
	36	43710	43942	44959	45041	45148
	39	43711	43943	44960	45042	45149
	40	43712	43944	44961	45043	45150
	41	43713	43945	44962	45044	45151
	73	43714	43946	44963	45045	-
	74	43715	43947	44964	45046	-
	77	43716	43948	44965	45047	45152
	79	43717	43949	44966	45048	-
	81	43718	43950	44967	45049	-
	89	43719	43951	44968	45050	45153
	91	43720	43952	44969	45051	45154
	92	43721	43953	44970	45052	-
	93	43762	43995	45013	45094	45155
	94	43722	43954	44971	45053	-
	351	43723	43955	44972	45054	-
	363	43724	43956	44973	45055	-
	372	43725	43957	44974	45056	-
	490	43727	43959	44976	45058	-
	560	43728	43960	44977	45059	-
	580	43729	43961	44978	45060	45156
	590	43730	43962	44979	45061	-
	665	43731	43963	44980	45062	-
	670	43732	43964	44981	45063	-
	951	43738	43970	44987	45069	-
	975	43739	43971	44988	45070	-
	1024	43740	43972	44989	45071	-
	1033	43741	43973	44990	45072	-
	1042	43742	43974	44991	45073	-
	1090	43744	43976	44993	45075	-

 packaging in blister no partial packaging

Customized PDS decors on request, see page 191



pack	10 pcs/blister	10 pcs	10 pcs/blister	10 pcs	10 pcs	
length cm	90	270	90	270	270	
ART.	422/AD	22/A	450/AD	50/A	63/A	
ALUMINIUM covered with ALCROM® PLUS film						
	1202	43746	43978	44995	45077	45158
	1203	43747	43979	44996	45078	45159
	1204	43748	43980	44997	45079	45160
	1205	43749	43981	44998	45080	45161
	1206	43750	43982	44999	45081	45162
	1207	43751	43983	45000	45082	45163
	1208	43752	43984	45001	45083	45164
	1209	43753	43985	45002	45084	45165
	1210	43754	43986	45003	45085	45166
	1211	43755	43987	45004	45086	45167
	1212	43756	43988	45005	45087	45168
	1213	43757	43989	45007	45088	45169
	1214	43758	43990	45008	45089	45170
	1215	43759	43991	45009	45090	45171
	1216	43760	43992	45010	45091	45172
	1217	43761	43993	45011	45092	45173
	100	-	43994	-	45093	-
	black 97	-	43996	-	45095	45175
euro/pc			-		-	-
euro/m			-		-	-

individually packed

PROCLASSIC F / PROLEVEL HIGH / PROTECT

pack	10 pcs/blister	10 pcs	10 pcs/blister	10 pcs	10 pcs	
length cm	90	270	90	270	270	
ART.	422/AD	22/A	450/AD	50/A	63/A	
ANODISED ALUMINIUM						
	silver	43790	44000	45019	45100	45190
euro/pc			-		-	-
euro/m			-		-	-
	titanium	43791	44001	45020	45101	45191
euro/pc			-		-	-
euro/m			-		-	-

individually packed



50/A titanium anodised aluminium



63/A silver anodised aluminium

prestowood

Prestowood 74/A is a line of stair nosing profiles covered with wood-effect Alcrom® Plus film, for the protection of already-laid wooden step edges. Available in adhesive version, they are particularly recommended for DIY installations.

74/ is also available in different finishes of anodised aluminium, as the stair nosing profiles 73/ and 58/.



74/A aluminium covered with Alcrom® Plus film

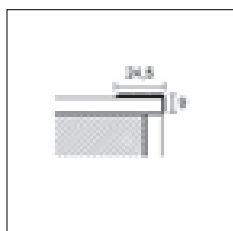

73/

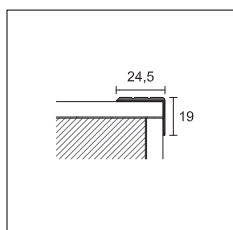

74/

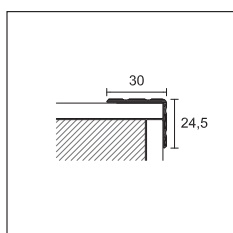

58/A

PRESTOWOOD

pack	10 pcs
length cm	270
ART.	74/A

finishing





ALUMINIUM covered with ALCROM® PLUS film

10	75319
12	75297
13	75301
20	75320
32	75303
36	75304
37	75305
38	75306
40	75322
47	75307
65	75294
71	75309
76	75334
78	75311
80	75326
92	75312
94	75313
95	75314

euro/m

individually packed

PROTECT

pack	30 pcs						20 pcs	
length cm	270							
ART.	73/			74/			58/	
finishing	F	SF	A	F	SF	A	A	
ALUMINIUM								
silver anodised	 75208	75209	75238	75268	75269	75298	75900	
euro/m								
gold anodised	 75218	-	75248	75278	-	75308	-	
euro/m								
bronze anodised	 -	-	75258	-	-	75318	-	
euro/m								
titanium anodised	 -						75299	-
euro/m								

RC is a line of edge profiles for the floating installation of wooden and laminate floors, available in different finishes of anodised aluminium or covered with wood-effect Alcrom® Plus film. This profile is also available in the bendable version RCF that can be curved with the specific Proflex Machine.

Prolevel High 732/ is a line of profiles for the protection of the perimetral border of wooden and laminate floors.



RC/9/F silver anodised aluminium

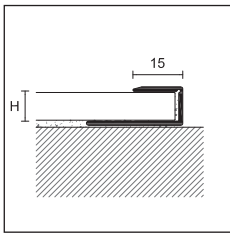

RC/ /F
RCF/



RCF/ silver anodised aluminium

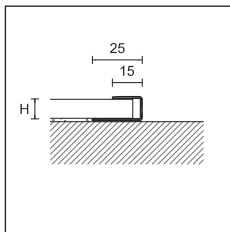

732/SF/



Complete the article code with H measure (for example RC/ /F for H = 9 becomes RC/9/F)

Customized PDS decors on request, see page 191

TERMINAL RC

length = 270 cm - pack 20 pcs

ART.	finishing	7	9	11	13	15	
ALUMINIUM							
	silver anodised		67407	67477	67547	67617	67687
	<i>euro/m</i>						
RC/ /F	gold anodised		-	67487	-	-	-
	<i>euro/m</i>		-	-	-	-	-
	bronze anodised		-	67497	-	-	-
	<i>euro/m</i>		-	-	-	-	-

length = 270 cm - pack 10 pcs

ART.	finishing	7	9	11	13	15
ALUMINIUM covered with ALCROM® PLUS film						
				H		
RC/ /F	10	-	66731	-	-	-
	20	-	66734	-	-	-
	38	-	66739	-	-	-
	40	-	66740	-	-	-
	42	-	66758	-	-	-
	65	-	66747	-	-	-
	78	-	66751	-	-	-
	80	-	66752	-	-	-
	<i>euro/m</i>					

TERMINAL RC

length = 90 cm - pack 10 pcs / blister

ART.	finishing	7	9	11	15	
ALUMINIUM						
	silver anodised		42782	41832	41877	42822
	<i>euro/pc</i>					
	gold anodised		-	41839	-	-
	<i>euro/pc</i>		-	-	-	-

TERMINAL RC FLEX

length = 270 cm - pack 10 pcs

ART.	finishing	9	11	
ALUMINIUM				
RCF/	silver anodised		67712	67714
	<i>euro/m</i>			
individually packed				

PROLEVEL HIGH

length = 270 cm - pack 15 pcs

ART.	finishing	10	12,5	
STAINLESS STEEL				
732/SF/	polished stainless steel AISI 430 DIN 1.4016		74217	74227
	<i>euro/m</i>			
individually packed				

alfix 616

Alfix 616 is a professional system for the laying of wooden and laminate floors with thickness from 6 to 16 mm. The system is composed of a top profile in anodised aluminium fixed with screws on a natural aluminium base. The screws, included in the packaging, have the same colour of the top profile in order to perfectly match it.



FIX/L/55 silver anodised aluminium

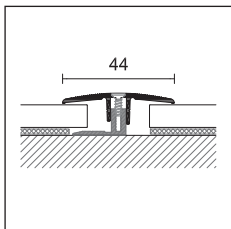

FIX/J/44







ALFIX 616

pack	10 pcs	10 pcs / blister 	
length cm	270	90	100

ART. FIX/J/44

for floor thicknesses from 6 to 16 mm

finishing			
ALUMINIUM			
silver anodised		37010	37012 37014
sand gold anodised		37210	37212 -
euro/m			-
euro/pc		-	
titanium anodised		37410	- 37414
elox bronze anodised		37310	37312 37314
euro/m			-
euro/pc		-	

individually packed

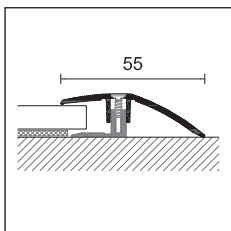





FIX/L/55

ALFIX 616

pack	10 pcs	10 pcs / blister 	
length cm	270	90	100

ART. FIX/L/55

for floor thicknesses from 6 to 16 mm

finishing			
ALUMINIUM			
silver anodised		37040	37042 37044
sand gold anodised		37240	37242 37244
euro/m			-
euro/pc		-	
titanium anodised		37440	37442 37444
elox bronze anodised		37340	- -
euro/m			-
euro/pc		-	

individually packed

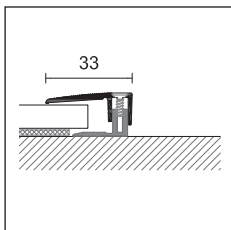





FIX/T/33

ALFIX 616

pack	10 pcs	10 pcs / blister 	
length cm	270	90	100

ART. FIX/T/33

for floor thicknesses from 6 to 16 mm

finishing			
ALUMINIUM			
silver anodised		37070	- 37074
sand gold anodised		37270	37272 -
euro/m			-
euro/pc		-	
titanium anodised		37470	- 37474
elox bronze anodised		-	- 37374
euro/m			-
euro/pc		-	

individually packed

 packaging in blister no partial packaging

Alfix 46 is a professional system designed to allow the expansion of Click LVT floors, also suitable for loose-lay LVTs. This system is characterized by top profiles in anodised aluminium, fixed with a screw system on a natural aluminium base. Screws, included in the package, have the same colour of the anodisation and, once fixed, integrate with the top profile.



FIX/J/30 silver anodised aluminium



FIX/L/32 silver anodised aluminium



FIX/T/19 silver anodised aluminium

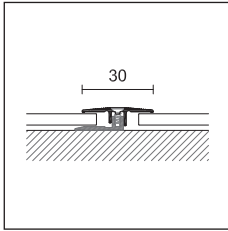

FIX/J/30

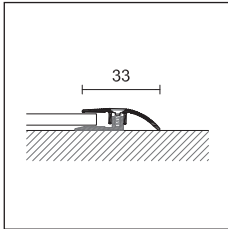

FIX/L/32

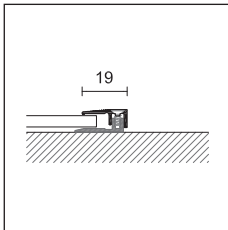

FIX/T/19

ALFIX 46

pack	10 pcs
length cm	270

ART. FIX/J/30

for floor thicknesses from 4 to 6 mm

finishing

ALUMINIUM

silver anodised		35500
-----------------	--	-------

euro/m

individually packed

ALFIX 46

pack	10 pcs
length cm	270

ART. FIX/L/32

for floor thicknesses from 4 to 6 mm

finishing

ALUMINIUM

silver anodised		35510
-----------------	--	-------

euro/m

individually packed

ALFIX 46

pack	10 pcs
length cm	270

ART. FIX/T/19

for floor thicknesses from 4 to 6 mm

finishing

ALUMINIUM

silver anodised		35520
-----------------	--	-------

euro/m

individually packed

cerfix® projoint DIL - pronivel

NZA/ is a dynamic expansion joint in aluminium composed of two interlocking sliding profiles. Suitable for Click LVT floors, it guarantees a good resistance to loads and intense foot traffic. Thanks to the exclusive solution with adhesive integrated into the internal anchor flange, it can be fixed directly to the plank and it is the perfect expansion joint for Click LVT floors with uninterrupted and perfectly flat surface.



NZA/5A silver anodised aluminium

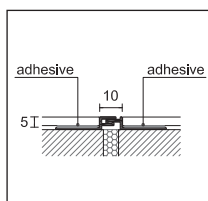

NZA/5A



PROJOINT DIL

length = 270 cm - pack 20 pcs

ART.	finishing	5A
ALUMINIUM		
	silver anodised	99310
	<i>euro/m</i>	
NZA/	titanium anodised	99314
	elox bronze anodised	99316
	<i>euro/m</i>	

individually packed

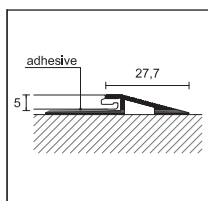

PBA/5/A



PRONIVEL PB

length = 270 cm - pack 10 pcs

ART.	finishing	H
ALUMINIUM		
PBA/5/A	silver anodised	93205
	<i>euro/m</i>	

individually packed

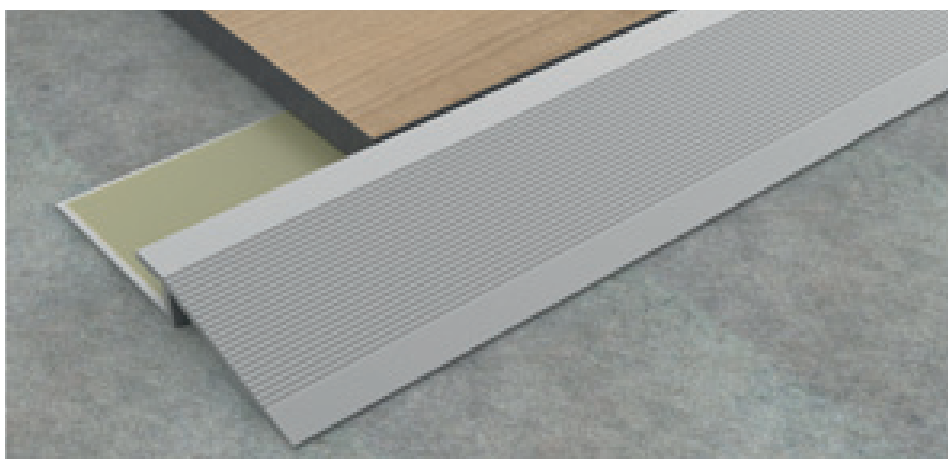

PBA/5A silver anodised aluminium

cerfix® projoint - pronivel

H/5/F, PBAS/5/F, RC/5/F and 99/TR/26 are connection profiles in anodised aluminium, for floating Click LVT floors and suitable as profiles for same height, different height and for borders.

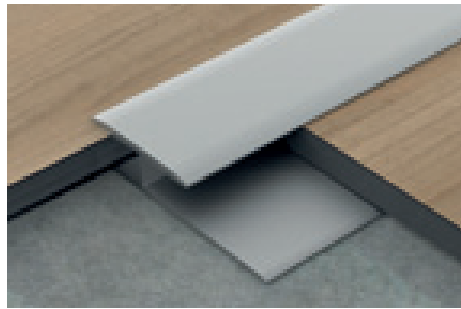

H/5/F silver anodised aluminium



PBAS/5/S silver anodised aluminium

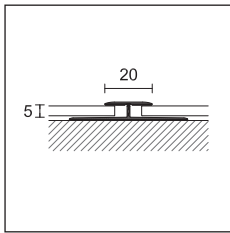

H/5/F



PROJOINT T

length = 270 cm - pack 20 pcs

H

ART. finishing

5

ALUMINIUM

H/5/F drilled silver anodised



75000

euro/m

individually packed

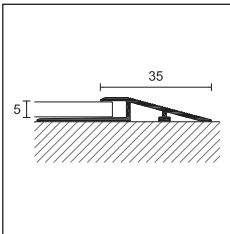

PBAS/5/F



PRONIVEL PB

length = 270 cm - pack 20 pcs

H

ART. finishing

5

ALUMINIUM

PBAS/5/F drilled silver anodised



95203

euro/m

individually packed

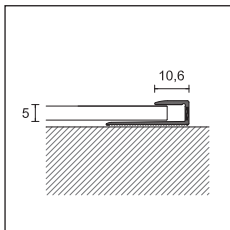

RC/5/F



TERMINAL RC

length = 270 cm - pack 20 pcs

H

ART. finishing

5

ALUMINIUM

RC/5/F drilled silver anodised



67475

euro/m

individually packed

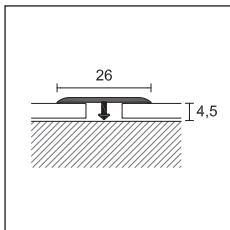

99/TR/26



PROJOINT T

length = 270 cm - pack 20 pcs

LxH

ART. finishing

26 x 4,5

ALUMINIUM

99/TR/26 silver anodised



75081

euro/m

individually packed

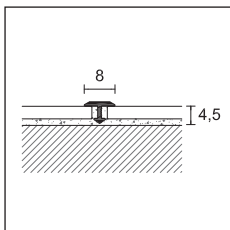

99/T/8



PROJOINT T

length = 270 cm - pack

50 pcs

width

8

ART. finishing

ALUMINIUM

99/T/ silver anodised



75075

euro/m

length = 270 cm - pack

50 pcs

BRASS

399/T/ polished



75070

euro/m

pack

30 pcs

399/TC/ chromium plated



75071

euro/m

individually packed

proststep - protect

SMA/, 75/F, 111/ /F and G/705/F are profiles in anodised aluminium suitable for stairs covered glue-down or loose-lay LVT.
ZGF/ is a profile in aluminium suitable for following the curvilinear course of stair or floors in glue-down or loose-lay LVT.



SMA/4 silver anodised aluminium

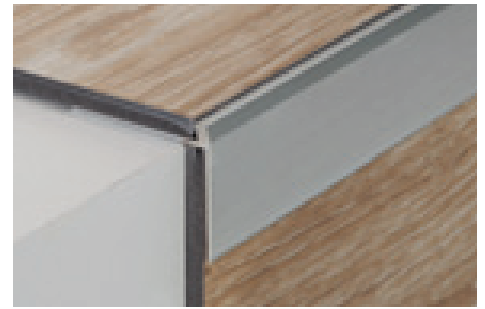

75/F silver anodised aluminium

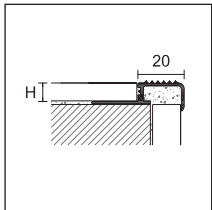

SMA/4



PROSTEP

length = 270 cm - pack 10 pcs

H

ART. finishing

4,5

ALUMINIUM

SMA/ natural aluminium

93967

euro/m

SMA/ silver anodised

93975

euro/m

individually packed

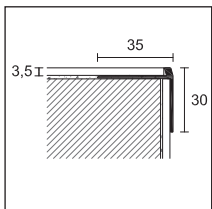

75/F



PROTECT

length = 340 cm - pack 20 pcs

H

ART. finishing

3,5

ALUMINIUM

75/F drilled silver anodised

75388

euro/m

PROTECT

length = 270 cm - pack 20 pcs

H

ART. finishing

2,5

4,5

5

ALUMINIUM

111/ /F silver anodised

75782

75784

75785

euro/m

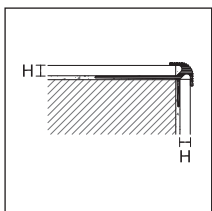

111/



PROSTEP

length = 270 cm - pack 10 pcs

H

ART. finishing

5

ALUMINIUM

G/705/F silver anodised

67580

euro/m

individually packed

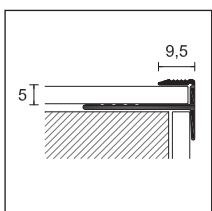

G/705/F



PRO FLEX LINE

PROANGLE FLEX

length = 270 cm - pack 10 pcs

H

ART. finishing

4,5

ALUMINIUM

ZGF/ natural aluminium

88721

euro/m

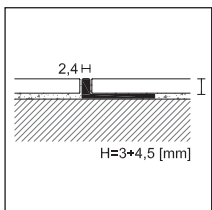

ZGF/



111/2,5/F silver anodised aluminium



G/705/F silver anodised aluminium

cerfix® protrim - proangle

RA/ and RI/ are profiles that are suitable for glue-down or loose-lay LVT floors and are recommended as border profiles for floors or stairs finishing.

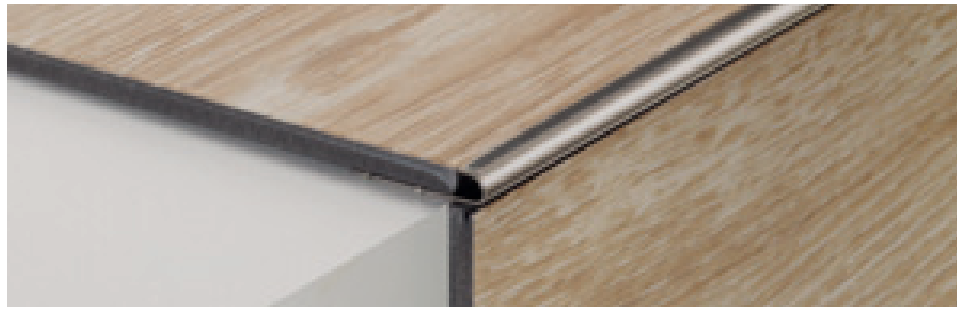

RI/4 stainless steel AISI 304 - DIN 1.4301

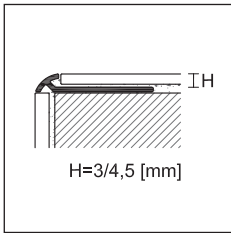

RA/

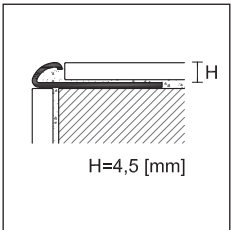

RI/

PROTRIM

length = 270 cm - pack 20 pcs

ART.	finishing	3	H	4,5
------	-----------	---	---	-----

ALUMINIUM

	silver anodised		92055	92056
--	-----------------	--	-------	-------

euro/m

RA/	gold anodised		92025	92026
-----	---------------	--	-------	-------

euro/m

	titanium anodised		92085	92086
--	-------------------	--	-------	-------

euro/m

individually packed

PROTRIM

length = 270 cm - pack 20 pcs

ART.	finishing	4,5	H	4,5
------	-----------	-----	---	-----

STAINLESS STEEL

RI/	stainless steel AISI 304 DIN 1.4301		92413	
-----	--	--	-------	--

euro/m

individually packed

ZA/, AI/, ZQAN/ and ZQKN/ are profiles suitable for glue-down or loose-lay LVT and are recommended as connection and border profiles.



ZA/4 silver anodised aluminium

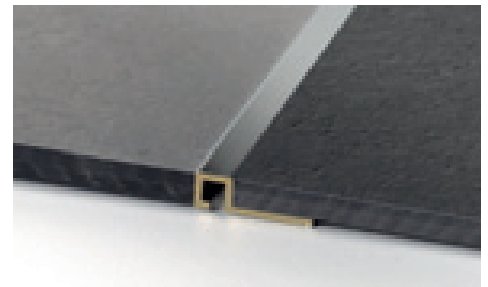

ZQKN/4 chromium-plated brass

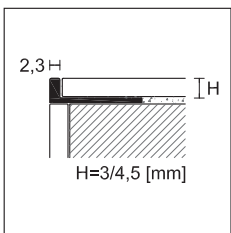

ZA/

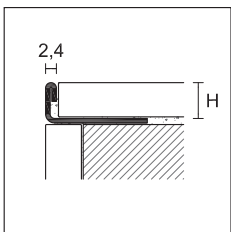

AI/

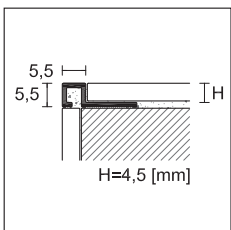

ZQAN/
ZQKN/

PROANGLE

length = 270 cm - pack 20 pcs

ART.	finishing	2,5	3	H	4,5
------	-----------	-----	---	---	-----

ALUMINIUM

ZA/	silver anodised		90337	90338	90340
-----	-----------------	--	-------	-------	-------

euro/m

STAINLESS STEEL

AI/	stainless steel AISI 304 DIN 1.4301		-	91636	91638
-----	--	--	---	-------	-------

euro/m

individually packed - version chromium - plated brass article ZK/4,5 see page 29

PROANGLE Q

length = 270 cm - pack 20 pcs

ART.	finishing	4,5	H	4,5
------	-----------	-----	---	-----

ALUMINIUM

	silver anodised		88772	
--	-----------------	--	-------	--

euro/m

ZQAN/	titanium anodised		88902	
-------	-------------------	--	-------	--

euro/m

BRASS

ZQKN/	chromium plated		88870	
-------	-----------------	--	-------	--

euro/m

individually packed

cerfix® proround

GA/, JGA/ and PIA/ are connection profiles for stairs in glue-down or loose-lay LVT floors. Easy to lay, they facilitate the hygienic maintenance of the connection between tread and riser.



GA/4 silver anodised aluminium



JGA/4 silver anodised aluminium

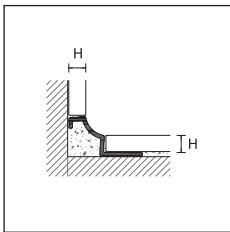

GA/



PROROUND M

length = 270 cm - pack 20 pcs

ART.	finishing	4,5
ALUMINIUM		
GA/	silver anodised	95730
<i>euro/m</i>		

individually packed

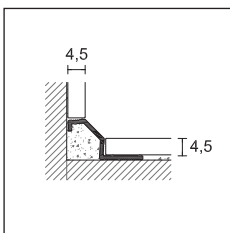

JGA/

PROROUND M

length = 270 cm - pack 20 pcs

ART.	finishing	4,5
ALUMINIUM		
JGA/	silver anodised	95732
<i>euro/m</i>		

individually packed

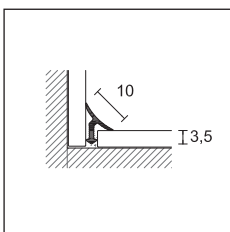

PIA/



PROINT

length = 270 cm - pack 20 pcs

ART.	finishing	3,5
ALUMINIUM		
PIA/	silver anodised	95431
<i>euro/m</i>		

individually packed



PIA/3 silver anodised aluminium

PVC Line skirting boards for wooden, laminate and LVT floors



PVC Line 8605 covered with Alcrom® Plus film, see page 212



PVC Line 8608 covered with Alcrom® Plus film, see page 213



PVC Line 8615 covered with Alcrom® Plus film, see page 214



PVC Line 8613 covered with Alcrom® Plus film, see page 215



PVC Line 8612 covered with Alcrom® Plus film, see page 216



PVC Line 8614 covered with Alcrom® Plus film, see page 216

Profilpas Digital System no limits to imagination



Profilpas gives the possibility to choose between over 400 standard decors Alcrom® Plus to combine the chosen profile or skirting board with the floor perfectly: indeed, a wide selection of wood, stone or concrete decors is available in our database to meet every need. Just consult our PDS bunch to discover the decor that best suits to your wish of combination.

But that's not all. The possibility of customization is really limitless with Profilpas. We just need to

receive a sample for creating any further decor, even a fantasy one!

This is possible thanks to Profilpas Digital System (PDS), the innovative digital printing technology of Profilpas to reproduce any decor on Alcrom Plus film and not to give limits to imagination! The whole production process is made inside our factory: from the scanner to the printing and the application of the film.

Please note: for customizations with decors that are not in our database, there is an extra of € for decor.

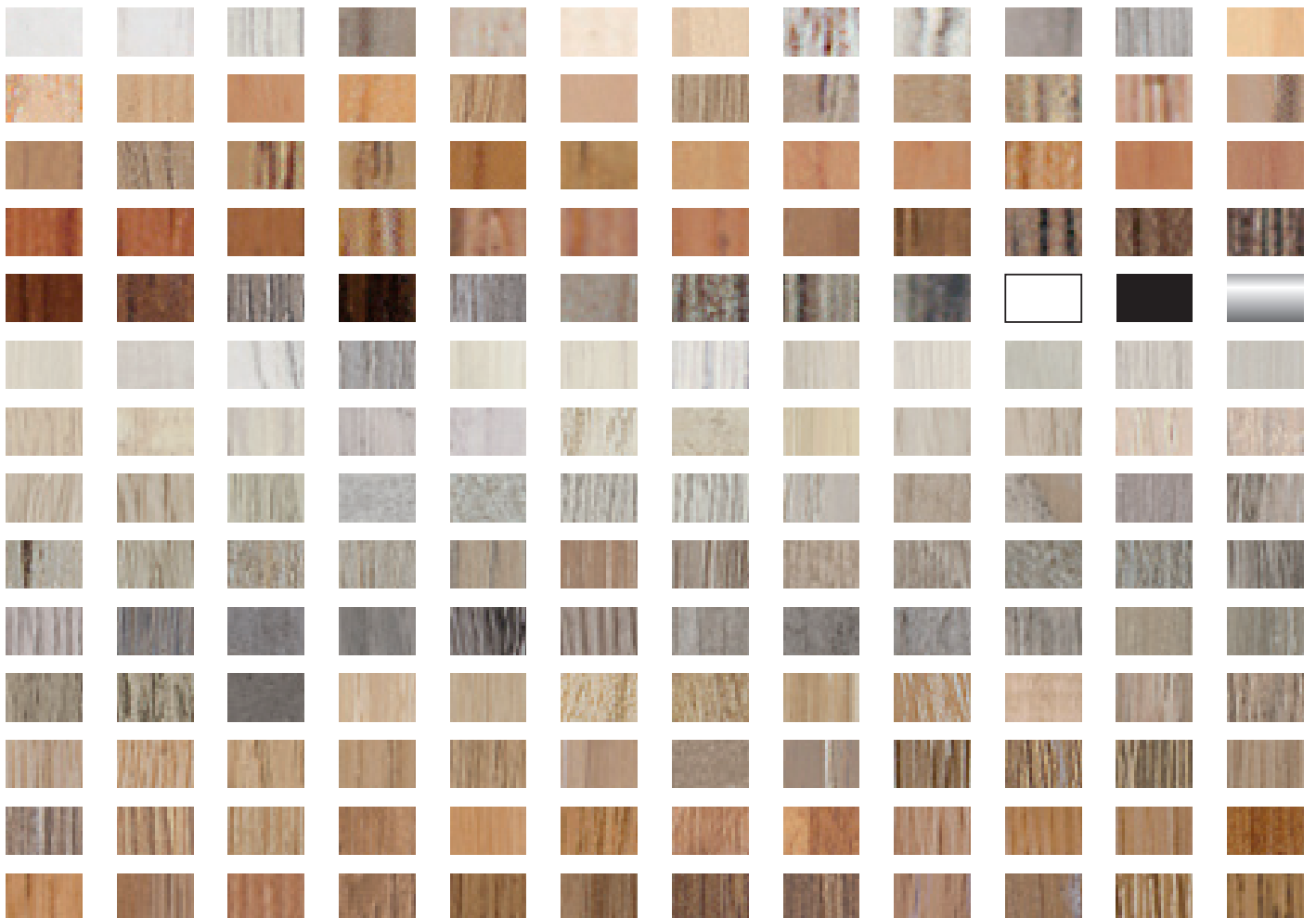



**UNISYSTEM PLUS Z/1, C/7, S/9
PROFIX THIN Z/4, C/4 AND S/4**

Quantity 20 pcs / 54 m = +	€/m
Quantity 40 pcs / 108 m = +	€/m
Quantity 60 pcs / 162 m = +	€/m
Quantity 80 pcs / 216 m = +	€/m
Quantity 100 pcs / 270 m = +	€/m

min. 54 m

Quantity 120 pcs / 324 m = +	€/m
Quantity 140 pcs / 378 m = +	€/m
Quantity 160 pcs / 432 m = +	€/m
Quantity 180 pcs / 486 m = +	€/m
Quantity 200 pcs / 540 m = +	€/m

Z3/30, C/10, C/13, C/22 E S/15

min. 540 m divisible into 5 decors

UNISYSTEM PLUS G/2 AND G/4

min. 540 m divisible into 5 decors

22/A, 50/A AND 63/A

min. 540 m divisible into 5 decors

74/A

min. 540 m divisible into 5 decors

RC/ /F

min. 540 m divisible into 5 decors

PVC LINE 8605, 8606, 8608, 8615, 8616, 8612, 8613 AND 8614

min. 540 m divisible into 2 decors

For the customization of other articles, please contact our Sales Department.

Please note: for customizations with decors that are not in our database, there is an extra of € for decor.



WOOD,
LAMINATE, LVT





metal line skirting board

To choose Metal Line means giving importance to details because they are the ones who make the difference. Metal Line is distinguished by its versatility and functionality, but also for its inspiration to contemporary design. It is an innovative line, rich of solutions with a wide variety of combinations and colours capable of satisfying every housing need, from small and large gathering places. Stainless steel and aluminium, materials that give shape, colour and size to the space, minimalist signs that follow the flow of everyday life. Metal Line can provide a continuum of profiles that integrate perfectly into environments and different styles, enhancing their aesthetic and architectural appeal. Metal Line becomes a trend line, thanks to Profilpas research on materials and shapes and to the attention of the company to the world of furniture and design.

skirting board metal line

Metal Line 90 is an aluminium skirting board, available in different finishes, that creates an elegant junction between the wall and the floor. Thanks to the curved section, this skirting board perfectly hides the perimetral expansion gap of a floating floor. Metal Line 90 is also available in white and black Trend Color Stone, two matt colours that perfectly match the most modern ceramic coverings. All the models can be curved through the specific Proflex Machine.

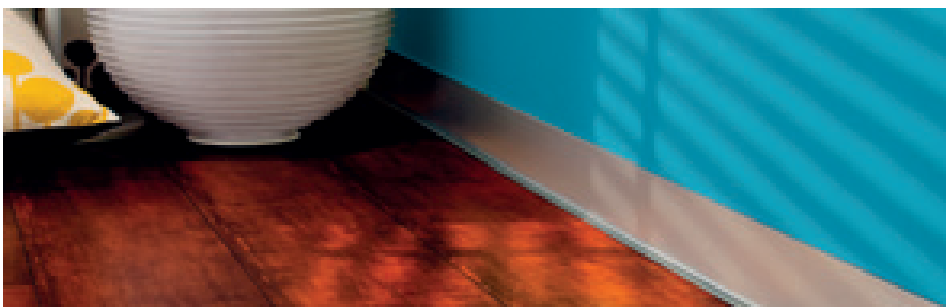

90/10 silver anodised aluminium

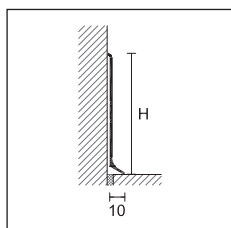

Metal Line 90 white stone colour-coated aluminium



Metal Line 90/6 silver anodised aluminium

TREND
COLOR

METAL LINE 90

length = 200 cm- pack 25 pcs

		H cm						
ART.	finishing	4	5	6	7	8	10	
ALUMINIUM								
	silver anodised		78080	78084	78100	78138	78130	78137
	euro/m							
	colour-coated polished white RAL 9010		-	-	78112	-	-	-
	colour-coated matt white RAL 9010		-	-	78110	-	-	-
	euro/m							
90/ SF	titanium anodised		-	-	78103	-	-	-
	euro/m							
	colour-coated anthracite grey		-	-	78118	-	-	-
	colour-coated ancient grey		-	-	78119	-	-	-
	euro/m							
90/ A	self-adhesive silver anodised		-	-	78106	-	78136	-
	euro/m							
90/ BSF	bright polished titanium		-	-	78142	-	78149	-
90/ SSF	bright brushed silver		78082	-	78105	-	78133	-
	bright brushed gold		-	-	78107	-	78135	-
	euro/m							
90/ TMSF	bright brushed titanium		78088	-	78102	-	78134	-
	euro/m							
TREND COLOR STONE								
90/ SF	colour-coated white stone		-	-	78094	-	-	-
	colour-coated black stone		-	-	78099	-	-	-
	euro/m							
ANTIBACTERIAL COLOUR-COATED ALUMINIUM								
90H/ SF	colour-coated white RAL 9003 antibacterial		-	-	78104	-	-	-
	euro/m							

individually packed

90/4SF, 90/5SF, 90/6SF and 90/8SF in silver anodised aluminium, available also in length 400 cm

PRO FLEX LINE

Metal Line 90 can be curved by using Proflex Machine + wheels kit for Metal Line 90 (vedi pag 250)

The self-adhesive version in height 4, 5, 7, and 10 is available on request, with a minimum order of 200 meters and a surcharge of

RAL 9003, RAL 7038, RAL 8019, RAL 9006, RAL 9007 colour-coated aluminium skirting boards are available on request, with a minimum order of 300 meters. For other colours, please contact our sales department.

Complete the article code with H measure (for example 90/SF for H=4 becomes 90/4SF)



inside corner, outside corner, junction and right-left end caps

INSIDE CORNER

pack 4 pcs		H cm					
ART.	finishing	4	5	6	7	8	10
METAL							
	silver		78630	78640	78650	78660	78670 78680
	<i>euro/pc</i>						
	titanium		-	-	78654	-	-
	polished white RAL 9010		-	-	78664	-	-
	matt white RAL 9010		-	-	78674	-	-
90/ MI	anthracite grey		-	-	78684	-	-
	ancient grey		-	-	78694	-	-
	polished titanium		-	-	78700	-	78712
	brushed silver		78718	-	78720	-	78722
	brushed gold		-	-	78724	-	78744
	brushed titanium		78714	-	78734	-	78754
	<i>euro/pc</i>						
90/ MI	white stone		-	-	78172	-	-
	black stone		-	-	78173	-	-
	<i>euro/pc</i>						
90H/ MI	white RAL 9003 antibacterial		-	-	78690	-	-
	<i>euro/pc</i>						

POLYPROPYLENE

90/ I	silver anodised		78236	78231	78190	78370	78195 78091
	<i>euro/pc</i>						

no partial packaging

JUNCTION

pack 4 pcs		H cm					
ART.	finishing	4	5	6	7	8	10
METAL							
	silver		78632	78642	78652	78662	78672 78682
	<i>euro/pc</i>						
	titanium		-	-	78656	-	-
	polished white RAL 9010		-	-	78666	-	-
	matt white RAL 9010		-	-	78676	-	-
90/ MG	anthracite grey		-	-	78686	-	-
	ancient grey		-	-	78696	-	-
	polished titanium		-	-	78699	-	78703
	brushed silver		78738	-	78740	-	78742
	brushed gold		-	-	78726	-	78746
	brushed titanium		78716	-	78736	-	78756
	<i>euro/pc</i>						
90/ MG	white stone		-	-	78187	-	-
	black stone		-	-	78188	-	-
	<i>euro/pc</i>						
90H/ MG	white RAL 9003 antibacterial		-	-	78692	-	-
	<i>euro/pc</i>						

POLYPROPYLENE

90/ G	silver anodised		78237	78232	78192	78372	78197 78092
	<i>euro/pc</i>						

no partial packaging

OUTSIDE CORNER

pack 4 pcs		H cm					
ART.	finishing	4	5	6	7	8	10
METAL							
	silver		78631	78641	78651	78661	78671 78681
	<i>euro/pc</i>						
	titanium		-	-	78655	-	-
	polished white RAL 9010		-	-	78665	-	-
	matt white RAL 9010		-	-	78675	-	-
90/ ME	anthracite grey		-	-	78685	-	-
	ancient grey		-	-	78695	-	-
	polished titanium		-	-	78698	-	78702
	brushed silver		78728	-	78730	-	78732
	brushed gold		-	-	78725	-	78745
	brushed titanium		78715	-	78735	-	78755
	<i>euro/pc</i>						
90/ ME	white stone		-	-	78174	-	-
	black stone		-	-	78178	-	-
	<i>euro/pc</i>						
90H/ ME	white RAL 9003 antibacterial		-	-	78691	-	-
	<i>euro/pc</i>						

POLYPROPYLENE

90/ E	silver anodised		78235	78230	78191	78371	78196 78090
	<i>euro/pc</i>						

no partial packaging

RIGHT/LEFT END CAPS

4 couples pack		H cm					
ART.	finishing	4	5	6	7	8	10
METAL							
	silver		78633	78643	78653	78663	78673 78683
	<i>euro/couple</i>						
	titanium		-	-	78657	-	-
	polished white RAL 9010		-	-	78667	-	-
	matt white RAL 9010		-	-	78677	-	-
90/ MP	anthracite grey		-	-	78687	-	-
	ancient grey		-	-	78697	-	-
	polished titanium		-	-	78701	-	78721
	brushed silver		78748	-	78750	-	78752
	brushed gold		-	-	78727	-	78747
	brushed titanium		78717	-	78737	-	78757
	<i>euro/couple</i>						
90/ MP	white stone		-	-	78189	-	-
	black stone		-	-	78199	-	-
	<i>euro/couple</i>						
90H/ MP	white RAL 9003 antibacterial		-	-	78693	-	-
	<i>euro/couple</i>						

POLYPROPYLENE

90/ P	silver anodised		78238	78233	78193	78373	78198 78093
	<i>euro/couple</i>						

no partial packaging

skirting board

metal line

Metal Line 790 is a skirting board in polished or brushed stainless steel, available in different heights, that follows the minimalist trends of modern design. Thanks to the curved section, this skirting board perfectly hides the perimetral expansion gap of a floating floor. Metal Line 790 can be easily and quickly installed through specific adhesives.



790/6 polished stainless steel AISI 304 DIN 1.4301

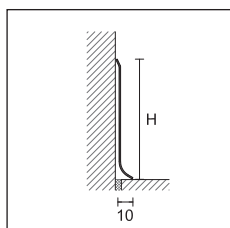

METAL LINE 790

length = 270 cm - pack 10 pcs

		H cm					
ART.	finishing	4	5	6	8	10	
STAINLESS STEEL							
790/ SF	polished stainless steel AISI 304 DIN 1.4301		78120	78108	78129	78132	78139
	brushed stainless steel AISI 304 DIN 1.4301		78128	78109	78126	78127	78140

individually packed - art. 790/10 SF pack 5 pcs

INSIDE CORNER IN METAL

pack 4 pcs

		H cm					
ART.	finishing	4	5	6	8	10	
790/ MI	finishing polished		78760	78761	78762	78763	78764
	<i>euro/pc</i>						
790/ MIS	finishing brushed		78780	78781	78782	78783	78784
	<i>euro/pc</i>						

no partial packaging

OUTSIDE CORNER IN METAL

pack 4 pcs

		H cm					
ART.	finishing	4	5	6	8	10	
790/ ME	finishing polished		78765	78766	78767	78768	78769
	<i>euro/pc</i>						
790/ MES	finishing brushed		78785	78786	78787	78788	78789
	<i>euro/pc</i>						

no partial packaging

JUNCTION IN METAL

pack 4 pcs

		H cm					
ART.	finishing	4	5	6	8	10	
790/ MG	finishing polished		78770	78771	78772	78773	78774
	<i>euro/pc</i>						
790/ MGS	finishing brushed		78790	78791	78792	78793	78794
	<i>euro/pc</i>						

no partial packaging

RIGHT/LEFT END CAPS IN METAL

4 couples pack

		H cm					
ART.	finishing	4	5	6	8	10	
790/ MP	finishing polished		78775	78776	78777	78778	78779
	<i>euro/couple</i>						
790/ MPS	finishing brushed		78795	78796	78797	78798	78799
	<i>euro/couple</i>						

no partial packaging



790/MI
790/MIS



790/ME
790/MES



790/MG
790/MGS



790/MP
790/MPS

The self-adhesive version is available in every height on request, with a minimum order of 200 meters and a surcharge of

Complete the article code with H measure (for example 790/SF for H=4 becomes 790/4SF)

Metal Line 92 and 93 are two skirting boards in aluminium, characterized by a simple design and a slightly-rounded shape, that create a perfect junction between the floor and the wall. These two elements are easy to install thanks to the interlocking system with supports, in natural aluminium or PVC, to be fixed to the wall with screws and dowels.



92/7 silver anodised aluminium + S/95 aluminium support

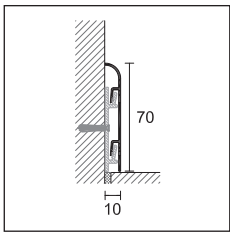

92/7



METAL LINE 92

length = 200 cm + 3 supports - pack 20 pcs

H cm

ART. finishing

7

ALUMINIUM

92/7 silver anodised
euro/m

78490

individually packed

ALUMINIUM SUPPORT

pack 100 pcs

S/95

78295

euro/pc

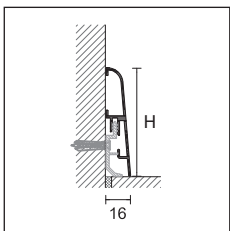

93/



METAL LINE 93

length = 200 cm + 5 supports - pack 20 pcs

H cm

ART. finishing

7

9

ALUMINIUM

93/ silver anodised
euro/m

78495

78496

individually packed

FIXING CLIPS

pack 100 pcs

8608/C

29751

euro/pack

Ancient grey, RAL 9003, RAL 7038, RAL 8019, RAL 9006, RAL 9007 colour-coated aluminium skirting boards are available on request, with a minimum order of 300 meters. For other colours, please contact our sales department.



93/7 silver anodised aluminium + 8608/C fixing clips

skirting board

metal line

Metal Line 89 is a skirting board in aluminium, in different finishes, characterized by square and minimalist lines; available in different heights, it outlines the space with simplicity and elegance. Fixed on the wall through specific adhesives, it perfectly hides the perimetral expansion gap of a floating floor, as well as having a decorative role. Metal Line 89 is also available in white and black Trend Color Stone, two matt colours that perfectly combines with the most modern ceramic coverings.

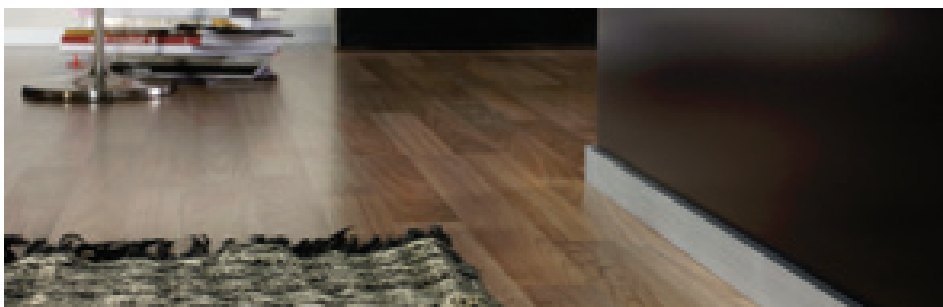

89/4 silver anodised aluminium

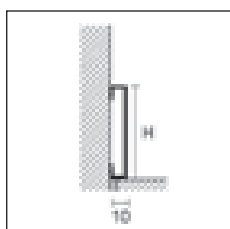

89/
89/ TM
89H/



89/ EI

TREND
COLOR



Metal Line 89 bright brushed titanium



89/4 ancient grey colour-coated aluminium + 89/4EI

METAL LINE 89

length = 200 cm - pack 25 pcs

		H cm		
ART.	finishing	4	6	8
ALUMINIUM				
	silver anodised	78378	78478	78487
	<i>euro/m</i>			
	titanium anodised	78521	78522	-
	<i>euro/m</i>			
89/	colour-coated matt white RAL 9010	78517	78518	-
	<i>euro/m</i>			
	colour-coated ancient grey	78515	78485	-
	colour-coated rust	78516	-	-
	<i>euro/m</i>			
89/ TM	bright brushed titanium	78388	78480	-
	<i>euro/m</i>			
TREND COLOR STONE				
89/	colour-coated white stone	78481	-	-
	colour-coated black stone	78482	-	-
	<i>euro/m</i>			
COLOUR-COATED ALUMINIUM ANTIBACTERIAL				
89H/	colour-coated white RAL 9003 antibacterial	-	78531	-
	<i>euro/m</i>			

individually packed

Ancient grey, RAL 9003, RAL 7038, RAL 8019, RAL 9006, RAL 9007 colour-coated aluminium skirting boards are available on request, with a minimum order of 300 meters. For other colours, please contact our sales department.

INSIDE/OUTSIDE CORNER - RIGHT/LEFT END CAP

		H cm		
ART.	finishing	4	6	8
pack 4 pcs				
ALUMINIUM				
	silver anodised	78505	78506	78527
	<i>euro/pc</i>			
	titanium anodised	78523	78524	-
	<i>euro/pc</i>			
89/ EI	colour-coated matt white RAL 9010	78519	78520	-
	<i>euro/pc</i>			
	colour-coated ancient grey	78512	78513	-
	colour-coated rust	78514	-	-
	<i>euro/pc</i>			
89/ TMEI	bright brushed titanium	78509	78510	-
	<i>euro/pc</i>			
89/ EI	colour-coated white stone	78507	-	-
	colour-coated black stone	78508	-	-
	<i>euro/pc</i>			
89H/ EI	colour-coated white RAL 9003 antibacterial	-	78533	-
	<i>euro/pc</i>			

no partial packaging

Complete the article code with H measure (for example 89/ for H=4 becomes 89/4).

In anodised aluminium, Metal Line 89 I Design is characterized by a special scratched finish and original colours that allow different chromatic combinations, created for interior designers and architects by following the latest trends of modern design.

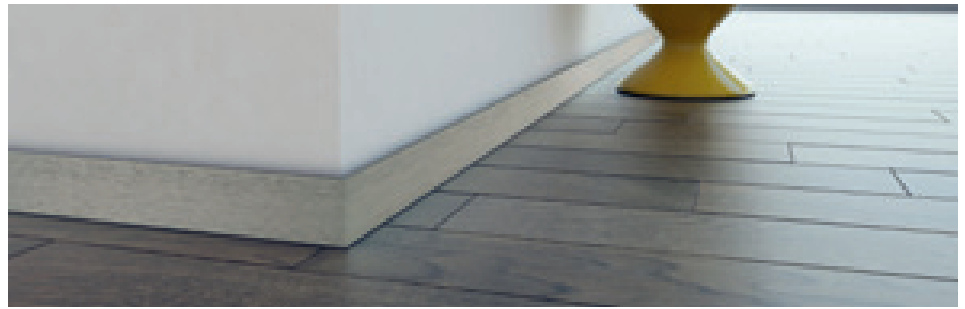

89/6 titanium anodised aluminium

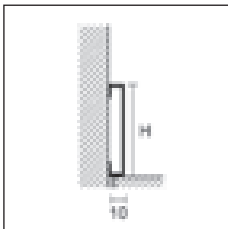

89/



METAL LINE - I DESIGN

length = 200 cm - pack 25 pcs

		H	
ART.	finishing	4	6
ANODISED ALUMINIUM			
89/	platinum		31400 31402
	titanium		31410 31412
	brown		31420 31422
	dark brown		31430 31432
	carbon		31440 31442
euro/m			

individually packed

INSIDE/OUTSIDE CORNER - RIGHT/LEFT END CAP

pack 2 pcs

		H	
ART.	finishing	4	6
ANODISED ALUMINIUM			
89/ EI	platinum		31450 31452
	titanium		31460 31462
	brown		31470 31472
	dark brown		31480 31482
	carbon		31490 31492
euro/pc			

no partial packaging

Complete the article code with H measure (for example 89/ for H=4 becomes 89/4)

Metal Line 89 is a skirting board in anodised aluminium with LED-strip lighting system. The light is distributed along the entire length of the profile through a diffuser element. It is possible to insert the dimmer in order to adjust the luminous intensity of the skirting board to decorate and light up the room.

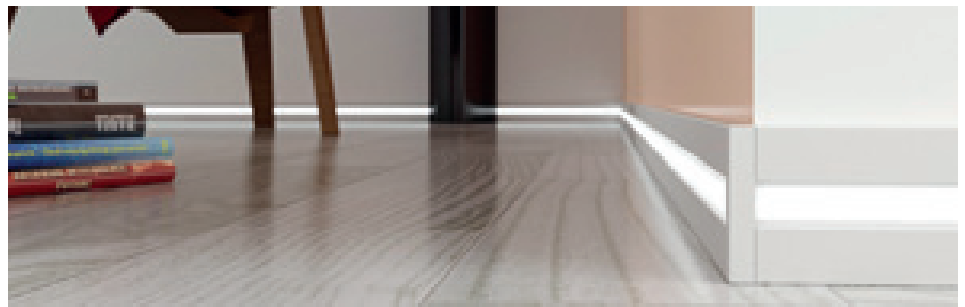

89/6L silver anodised aluminium

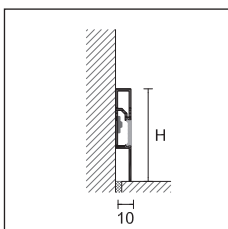

89/6L



PROLIGHT METAL LINE 89

length = 200 cm - pack 25 pcs

		H cm	
ART.	finishing	6	
ALUMINIUM			
89/6L	silver anodised		86000
euro/m			

individually packed

INSIDE/OUTSIDE CORNER - RIGHT/LEFT END CAP

pack 4 pcs

		H cm	
ART.	finishing	6	
ALUMINIUM			
89/6EI	silver anodised		78506
euro/pc			

no partial packaging



89/6EI

For the best aesthetic result and the validity of the warranty, we suggest the exclusive use of our electrical components. See page 236

skirting board

metal line

Metal Line 89/613 is a skirting board in aluminium characterized by square and minimalist lines. With a thickness of 13 mm, it perfectly hides the perimetral expansion gap of a floating floor.



89/613 silver anodised aluminium

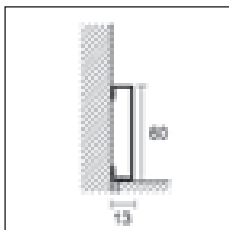

89/613



METAL LINE 89/613

length = 200 cm - pack 25 pcs

H cm

ART. finishing

6

ALUMINIUM

silver anodised		78486
euro/m		
89/613 colour-coated matt white RAL 9010	<input type="checkbox"/>	78488
euro/m		

individually packed

INSIDE/OUTSIDE CORNER - RIGHT/LEFT END CAP

pack 4 pcs

H cm

ART. finishing

6

ALUMINIUM

silver anodised		78525
euro/pc		
89/613E colour-coated matt white RAL 9010	<input type="checkbox"/>	78526
euro/pc		

no partial packaging



89/613 EI

Metal Line 105 is a skirting board in aluminium, characterized by square and minimalist lines. This model stands out for a simple and quick interlocking installation system with a coextruded PVC base to be fixed to the wall through screws and dowels.



Metal Line 105 silver anodised aluminium

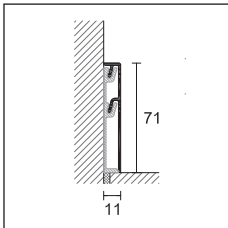

105/7
105/CB



METAL LINE

pack 10 pcs **H cm**

ART. finishing length 7

ALUMINIUM

105/7	silver anodised		200 cm	78900
	silver anodised		400 cm	78910

euro/m

individually packed

FIXING BASE

pack 10 pcs **H cm**

ART. length 7

CO-EXTRUDED PVC

105/CB	white		200 cm	78920
--------	-------	--	--------	-------

euro/m

no partial packaging

INSIDE CORNER

pack 4 pcs **H cm**

ART. finishing 7

METAL

105/7I	silver			78932
--------	--------	--	--	-------

euro/pc

no partial packaging

OUTSIDE CORNER

pack 4 pcs **H cm**

ART. finishing 7

METAL

105/7E	silver			78934
--------	--------	--	--	-------

euro/pc

no partial packaging

JUNCTION

pack 4 pcs **H cm**

ART. finishing 7

METAL

105/7G	silver			78936
--------	--------	--	--	-------

euro/pc

no partial packaging

RIGHT/LEFT END CAP

4 couples pack **H cm**

ART. finishing 7

METAL

105/7P	silver			78938
--------	--------	--	--	-------

euro/couple

no partial packaging

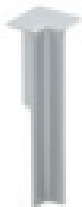

105/7I



105/7E



105/7G



105/7P

metal line

Metal Line 87/6 and 88/6 are two flush recessed skirting boards for plaster and plasterboards. Both are composed of two separate elements: a base in natural aluminium and an insert in silver anodised or matt white colour-coated aluminium. Once installed, the skirting board integrates perfectly into the wall surface, outlining the perimeter of the space without limiting it. There are two different phases of installation: the base element must be installed when the room is still in its rough state, while the chosen insert must be put after the laying of the floor.



87/6 e 88/6 natural aluminium + 88/16L/A aluminium insert for LED light

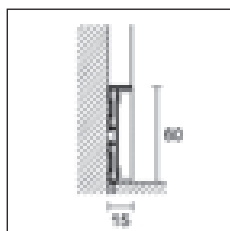

87/6 + 88/16SF
aluminium insert

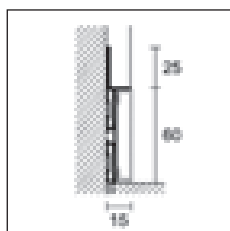

88/6 + 88/16SF
aluminium insert

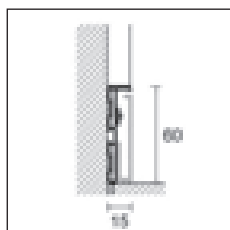

87/6 + 88/16L/A
aluminium insert for
LED light

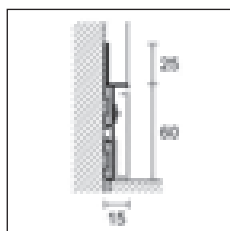

88/6 + 88/16L/A
aluminium insert for
LED light



88/6E

METAL LINE 87 E 88

length = 200 cm - pack 20 pcs

H cm

ART. finishing

6

ALUMINIUM

87/6 natural aluminium (drilled)

78338

euro/m

88/6 natural aluminium (drilled)

78310

euro/m

individually packed

ALUMINIUM INSERT

length = 200 cm - pack 20 pcs

H cm

ART. finishing

6

88/16SF silver anodised

78563

88/16SF matt white RAL 9010
colour-coated

78558

euro/m

individually packed

ALUMINIUM INSERT FOR LED LIGHT

length = 200 cm - pack 20 pcs

H cm

88/16L/A silver anodised

78559

88/16L/A matt white RAL 9010
colour-coated

78560

euro/m

adhesive - individually packed
for electrical components, see page 236

METAL OUTSIDE CORNER

pack 4 pcs

H cm

ART. finishing

6

88/6E silver

78561

88/6E matt white RAL 9010
colour-coated

78562

euro/pc

no partial packaging



88/6 natural aluminium + 88/16SF matt white aluminium insert

For the best aesthetic result and the validity of the warranty, we suggest the exclusive use of our electrical components. See page 236

Prolight Metal Line SKL/2 is a skirting board in aluminium with indirect LED light. Its special section allows to create an original play of light along the wall, thus adding value to the whole surface. In addition to the silver anodised and the white stone versions, SKL/2 is available in a wide range of colours including five original cement effects, two special metal tonalities and a white characterized by an extremely solid and full colour.

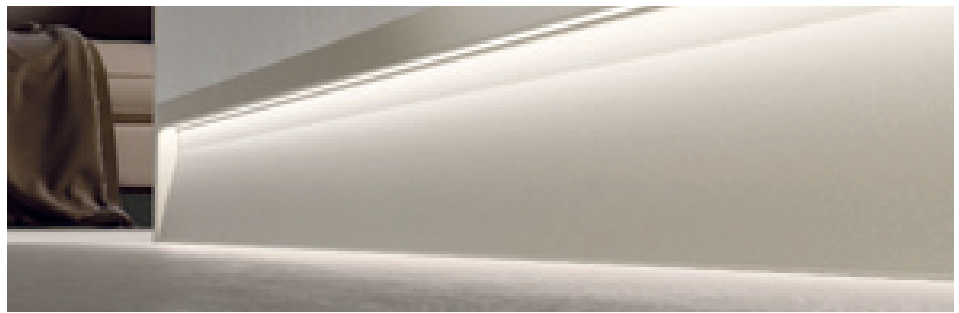

SKL/2 concrete white colour-coated aluminium

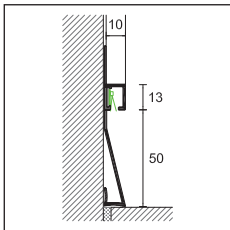

SKL/2



TREND
COLOR

PROLIGHT METAL LINE S

length = 270 cm - pack 5 pcs

H

ART. finishing

10

ALUMINIUM

SKL/2 silver anodised
euro/m

78579

COLOUR-COATED ALUMINIUM

SKL/2	white stone	78591
	concrete white	78592
	concrete graphite	78593
	concrete smoke	78594
SKL/2	concrete mud	78595
	concrete sand	78596
	metal dark	78597
	metal light	78598
	solid white	78599
	euro/m	

individually packed

ELECTRICAL COMPONENTS AND ACCESSORIES FOR LIGHTING

ART.	description	
L5/NW/65 L	spool 5 m LED strips, lateral light, neutral colour 4000 °K, 9,6W/m IP65	84136
	euro/mt (euro/pack)	

For other electrical components see page 236

Metal Line AF M Design is a skirting board in aluminium characterized by modern and minimalist lines that mark the connection between floors and coverings of same or different materials. The empty space creates an elegant shadow that highlights the two surfaces distinctly.



AF/1/ silver anodised aluminium

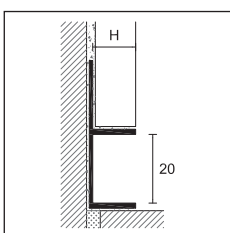

AF/1/



METAL LINE AF - M DESIGN

length = 270 cm - pack 10 pcs

H

ART. finishing

6

10

12,5

ALUMINIUM

	silver anodised	13198	13199	13200
	euro/m			
AF/1/	titanium anodised	13201	13203	13202
	colour-coated polished white RAL 9010	13196	13197	13204
	euro/m			

individually packed

metal line

Metal Line 100 is an anodized aluminium baseboard available in two heights and suitable for application of plasterboard, directly into the wall. The profile is easy to apply through the use of appropriate adhesives.

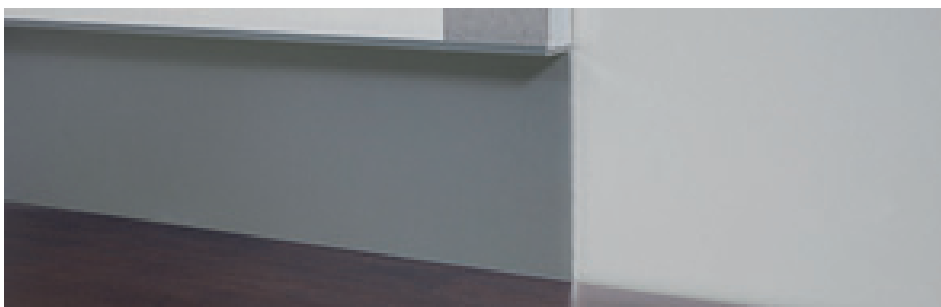

100/70 silver anodised aluminium

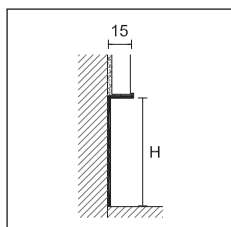

100/



METAL LINE 100

length = 200 cm - pack 20 pcs

H mm

ART.	finishing	40	70
------	-----------	----	----

ALUMINIUM

100/	silver anodised		78277	78279
------	-----------------	--	-------	-------

individually packed

Metal Line 101, ideal for plaster and made of anodized aluminium, is suitable for application directly on the rough wall. The profile is applied using special adhesives, before making the plastering of the wall.



101/74 silver anodised aluminium

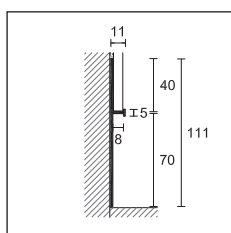

101/74



METAL LINE 101

length = 200 cm - pack 20 pcs

H mm

ART.	finishing	70
------	-----------	----

ALUMINIUM

101/74	silver anodised		78281
--------	-----------------	--	-------

individually packed

ADHESIVE

Cartridges 12 pcs - 300 ml (MS 45) and 290 ml (MS 55)

ART.

MAPEFLEX MS 45	white	<input type="checkbox"/>	6PB010043
----------------	-------	--------------------------	-----------

MAPEFLEX MS 55	white	<input type="checkbox"/>	6PV010043
----------------	-------	--------------------------	-----------

For further information, please see Mapei price list.

Ancient grey, RAL 9003, RAL 7038, RAL 8019, RAL 9006, RAL 9007 colour-coated aluminium skirting boards are available on request, with a minimum order of 300 meters. For other colours, please contact our sales department.

Metal Line 95 is a skirting board in aluminium, available in two different heights, that allows to hide service cables (telephone, computers, TV etc.). This model is characterized by a simple and quick interlocking installation system with natural aluminium supports that, fixed to the wall with screws and dowels, facilitate the removal for the maintenance of the service cables.

Metal Line 94/7SF is a skirting board with a section that facilitates fixing to the wall with cement-based adhesives.

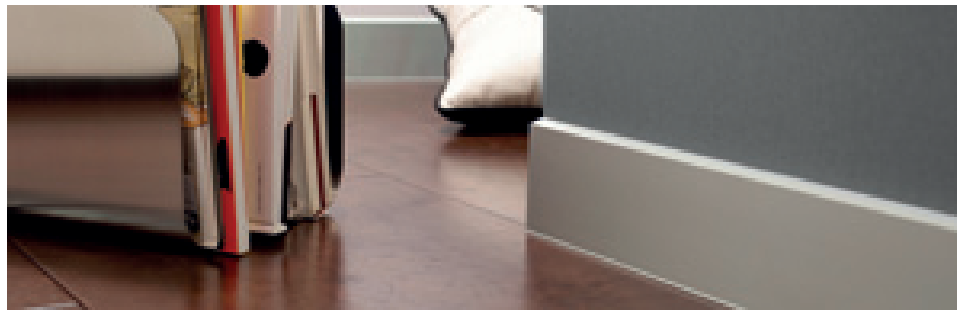

95/7SF silver anodised aluminium

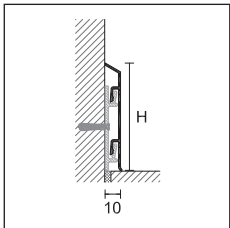

95/



METAL LINE 95

pack 25 pcs	length	H cm	
ART. finishing		7	10
ALUMINIUM			
95/ SF silver anodised	200 cm + 3 supports	78160	78175
	400 cm + 6 supports	78161	78176
euro/m			

individually packed - length 400 cm pack 10 pcs

ALUMINIUM SUPPORT

pack 100 pcs	
S/95	78295
euro/pc	
no partial packaging	

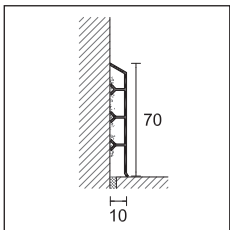

94/7SF

NEW

METAL LINE 94

length = 200 cm - pack 25 pcs	
ART. finishing	
ALUMINIUM	
94/7SF silver anodised	78354
euro/m	
individually packed	



95/7I inside corner

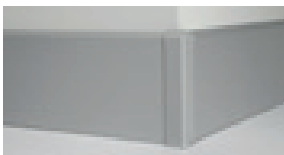

95/7E outside corner



95/7G junction

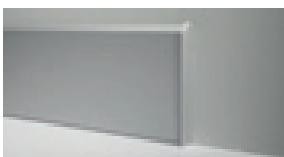

95/7P right end cap

INSIDE CORNER IN POLYPROPYLENE

pack 4 pcs		H cm
ART. finishing	7	10
95/ I silver anodised	78201	78206
euro/pc		
no partial packaging		

OUTSIDE CORNER IN POLYPROPYLENE

pack 4 pcs		H cm
ART. finishing	7	10
95/ E silver anodised	78200	78205
euro/pc		
no partial packaging		

JUNCTION IN POLYPROPYLENE

pack 4 pcs		H cm
ART. finishing	7	10
95/ G silver anodised	78202	78207
euro/pc		
no partial packaging		

RIGHT/LEFT END CAPS IN POLYPROPYLENE

4 couples pack		H cm
ART. finishing	7	10
95/ P silver anodised	78203	78208
euro/couple		
no partial packaging		

Ancient grey, RAL 9003, RAL 7038, RAL 8019, RAL 9006, RAL 9007 colour-coated aluminium skirting boards are available on request, with a minimum order of 300 meters. For other colours, please contact our sales department.

Complete the article code with H measure (for example 95/SF for H=7 becomes 95/7SF)

metal line

Metal Line 98 is a skirting board in aluminium characterized by round and soft lines and a thickness that allows the housing of service cables (telephone, computer, TV, etc.). A simple and functional interlocking installation system with natural aluminium supports to be fixed to the wall provides easy access to the cables for their maintenance.



98/7SF silver anodised aluminium

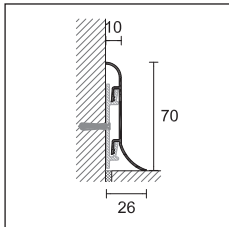

98/7SF



METAL LINE 98

pack 20 pcs

H cm

ART.	finishing	length	7
------	-----------	--------	---

ALUMINIUM

98/7SF	silver anodised	200 cm + 3 supports	78040
		400 cm + 6 supports	78041

euro/m

individually packed - length 400 cm pack 10 pcs

ALUMINIUM SUPPORT

pack 100 pcs

S/95	78295
------	-------

euro/pc

no partial packaging

INSIDE CORNER IN POLYPROPYLENE

pack 4 pcs

H cm

ART.	finishing	7
------	-----------	---

98/7I	silver anodised	78221
-------	-----------------	-------

euro/pc

no partial packaging

OUTSIDE CORNER IN POLYPROPYLENE

pack 4 pcs

H cm

ART.	finishing	7
------	-----------	---

98/7E	silver anodised	78220
-------	-----------------	-------

euro/pc

no partial packaging

JUNCTION IN POLYPROPYLENE

pack 4 pcs

H cm

ART.	finishing	7
------	-----------	---

98/7G	silver anodised	78222
-------	-----------------	-------

euro/pc

no partial packaging

RIGHT/LEFT END CAPS IN POLYPROPYLENE

4 couples pack

H cm

ART.	finishing	7
------	-----------	---

98/7P	silver anodised	78223
-------	-----------------	-------

euro/couple

no partial packaging



98/7SF silver anodised aluminium + S/95 aluminium support

Ancient grey, RAL 9003, RAL 7038, RAL 8019, RAL 9006, RAL 9007 colour-coated aluminium skirting boards are available on request, with a minimum order of 300 meters. For other colours, please contact our sales department.

Metal Line 97/4 is a 4 cm high aluminium skirting board that allows the housing of service cables (telephone, computer, TV, etc.). Thanks to a simple interlocking installation system with harmonic steel clips to be fixed to the wall with screws and dowels, it combines ease and speed of installation with easy access to the cables for their maintenance.

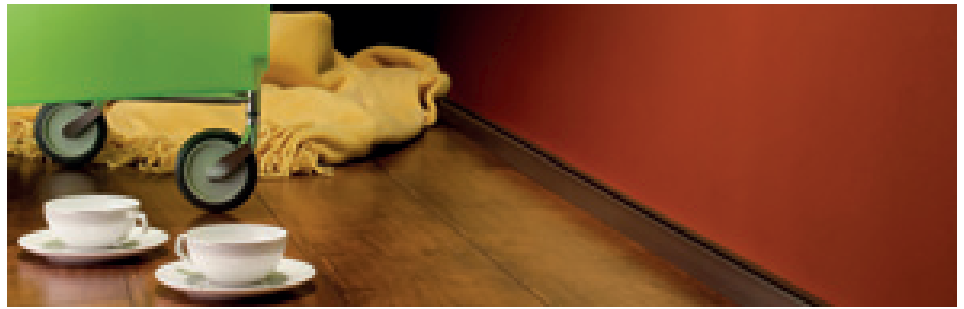

97/4SF

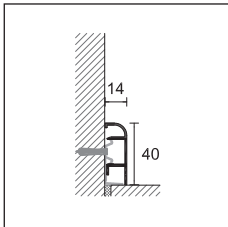

97/



METAL LINE 97

length = 200 cm - pack 25 pcs

H cm

ART. finishing

4

ALUMINIUM

97/4SF silver anodised



78000

+ 5 clips
euro/m

individually packed

FIXING CLIPS

10 blister packs / 20 pcs/blister

8602/C

29750

euro/blister

no partial packaging

INSIDE CORNER IN POLYPROPYLENE

pack 4 pcs

H cm

ART. finishing

4

97/4I silver anodised



78002

euro/pc

no partial packaging

OUTSIDE CORNER IN POLYPROPYLENE

pack 4 pcs

H cm

ART. finishing

4

97/4E silver anodised



78001

euro/pc

no partial packaging

JUNCTION IN POLYPROPYLENE

pack 4 pcs

H cm

ART. finishing

4

97/4G silver anodised



78003

euro/pc

no partial packaging

RIGHT/LEFT END CAPS IN POLYPROPYLENE

4 couples pack

H cm

ART. finishing

4

97/4P silver anodised



78004

euro/couple

no partial packaging



97/4SF silver anodised aluminium + 8602/C fixing clip

Ancient grey, RAL 9003, RAL 7038, RAL 8019, RAL 9006, RAL 9007 colour-coated aluminium skirting boards are available on request, with a minimum order of 300 meters. For other colours, please contact our sales department.

skirting board

metal line

Metal Line 97/7 is a 7 cm high aluminium skirting board with a simple and linear design. Easy and quick to install thanks to an interlocking installation system with natural aluminium supports to be fixed to the wall with screws and dowels, it provides easy access to the cables for their maintenance.

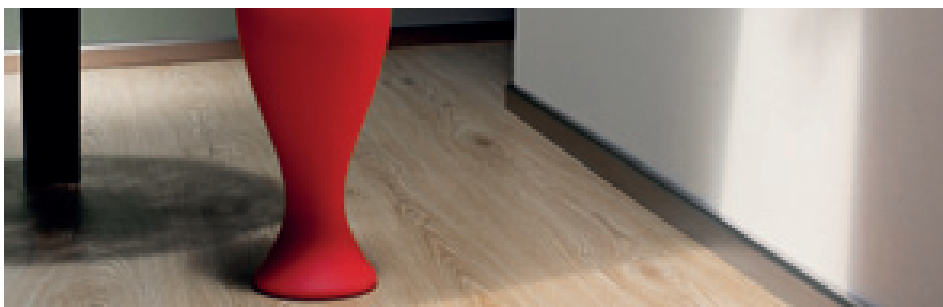

97/7SF silver anodised aluminium

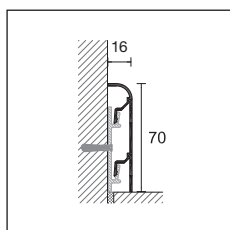

97/7SF



METAL LINE 97

length = 200 cm - pack 20 pcs

H cm

ART. finishing

7

ALUMINIUM

97/7SF +
3 supports

silver anodised



78005

euro/m

individually packed

ALUMINIUM SUPPORT

pack 100 pcs

S/95

78295

euro/pc

no partial packaging

INSIDE CORNER IN POLYPROPYLENE

pack 4 pcs

H cm

ART. finishing

7

97/7I silver anodised



78157

euro/pc

no partial packaging

OUTSIDE CORNER IN POLYPROPYLENE

pack 4 pcs

H cm

ART. finishing

7

97/7E silver anodised



78156

euro/pc

no partial packaging

JUNCTION IN POLYPROPYLENE

pack 4 pcs

H cm

ART. finishing

7

97/7G silver anodised



78158

euro/pc

no partial packaging

RIGHT/LEFT END CAPS IN POLYPROPYLENE

4 couples pack

H cm

ART. finishing

7

97/7P silver anodised



78159

euro/couple

no partial packaging

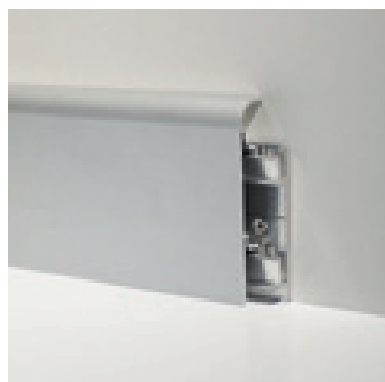

97/7SF silver anodised aluminium
+ S/95 aluminium support

Ancient grey, RAL 9003, RAL 7038, RAL 8019, RAL 9006, RAL 9007 colour-coated aluminium skirting boards are available on request, with a minimum order of 300 meters.

For other colours, please contact our sales department.

Metal Line 97/8 is a 8 cm high aluminium skirting board specially designed for housing cables thanks to the specific PVC cable trunking that, fixed to the wall with screws and dowels, also acts as support of the skirting board. It is particularly suitable for renovations as it avoids making new tracks for the passage of cables. It is also easy and quick to install only using natural aluminium supports that, fixed to the wall with screws and dowels, make the access to service cables easy.

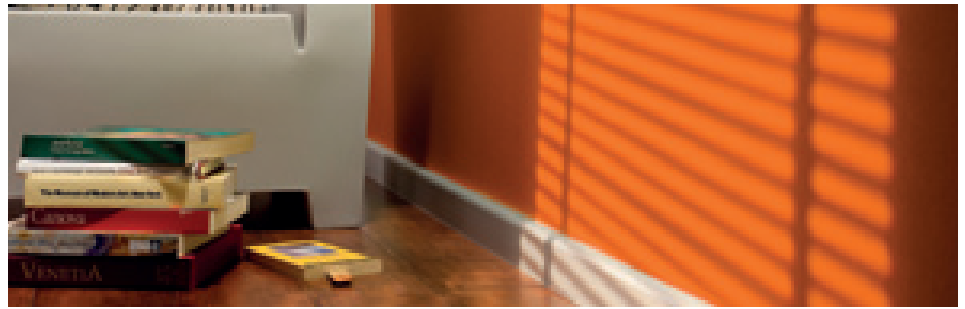

97/8SF silver anodised aluminium

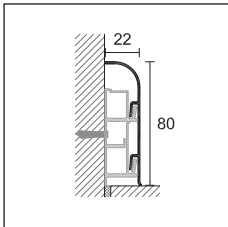

97/8SF



METAL LINE 97

pack 20 pcs			H cm
ART.	finishing	length	8
ALUMINIUM			
97/8SF	silver anodised	200 cm + 3 supports	78010
		400 cm + 6 supports	78011
<i>euro/m</i>			

individually packed - length 400 cm pack 10 pcs

WHITE PVC TRUNKING

length 200 cm - pack 20 pcs		
ART.	finishing	78290
97/8CB	<input type="checkbox"/>	78290
<i>euro/m</i>		

no partial packaging

ALUMINIUM SUPPORT

pack 100 pcs		
S/97		78299
<i>euro/pc</i>		

no partial packaging

INSIDE CORNER IN POLYPROPYLENE

pack 4 pcs			H cm
ART.	finishing		8
97/8I	silver anodised		78211
<i>euro/pc</i>			

no partial packaging

OUTSIDE CORNER IN POLYPROPYLENE

pack 4 pcs			H cm
ART.	finishing		8
97/8E	silver anodised		78210
<i>euro/pc</i>			

no partial packaging

JUNCTION IN POLYPROPYLENE

pack 4 pcs			H cm
ART.	finishing		8
97/8G	silver anodised		78212
<i>euro/pc</i>			

no partial packaging

RIGHT/LEFT END CAPS IN POLYPROPYLENE

4 couples pack			H cm
ART.	finishing		8
97/8P	silver anodised		78213
<i>euro/couple</i>			

no partial packaging



97/8SF silver anodised aluminium + 97/8CB white pvc trunking

Ancient grey, RAL 9003, RAL 7038, RAL 8019, RAL 9006, RAL 9007 colour-coated aluminium skirting boards are available on request, with a minimum order of 300 meters. For other colours, please contact our sales department.





PVC line skirting board

A range of PVC skirting boards to meet all technical and aesthetical needs. Suitable for both professional and DIY use, some models can be customised using digital printing technology PDS.

skirting board

pvc line

PVC Line 8605 and 8606 are two skirting boards in co-extruded PVC, characterized by a rounded shape and a 70-mm height. Both are composed of a core in foam PVC and a visible surface in coloured rigid PVC to guarantee the best aesthetic result and colour uniformity. 8605 can also be covered with Alcrom® Plus film and can be further customized thanks to the digital printing technology Profilpas Digital System. 8505 and 8606 can be fixed to the wall with adhesive (like MS 45 or MS 55) or nails. Moreover, they do not absorb water and are resistant to impact, wear and tear, UV rays and the products normally used for cleaning floors and wall coverings.



8606 white RAL 9003 co-extruded PVC

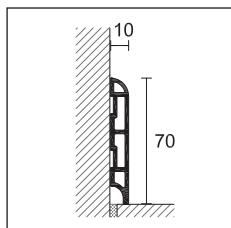

8605

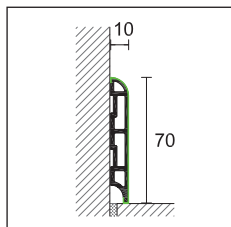

8605 covered with Alcrom® Plus film



8605 foam PVC covered with Alcrom® Plus film

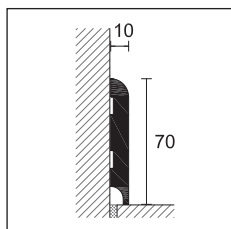

8606

Adhesive for skirting boards see page 249

For customizations with decors that are not in our database, there is an extra of € for decor.

PVC LINE

length 250 cm - pack 20 pcs - H = 70 mm

CO-EXTRUDED PVC (FOAM PVC + RIGID PVC)

ART.

8605	<input type="checkbox"/>	white RAL 9003	29175
	<input type="checkbox"/>	white RAL 9010	29177

euro/m

no partial packaging

PVC LINE

length 250 cm - pack 20 pcs - H = 70 mm

CO-EXTRUDED PVC (FOAM PVC + RIGID PVC) COVERED WITH ALCROM® PLUS FILM

ART. decors

8605	<input type="checkbox"/>	96 white RAL 9010 embossed	29030
	<input checked="" type="checkbox"/>	97 black RAL 9005 embossed	29031

euro/m

8605	<input checked="" type="checkbox"/>	99 brushed silver	29035
	<input type="checkbox"/>	100 brushed steel	29036

euro/m

no partial packaging

PVC LINE

length = 250 cm - pack 20 pcs - H = 70 mm

CO-EXTRUDED PVC (FOAM PVC + RIGID PVC) COVERED WITH ALCROM® PLUS FILM

ART.	decors		decors		decors		decors	
8605	02	29000	44	29013	1009	29103	1063	29121
	08	29001	47	29033	1012	29104	1066	29122
	10	29003	48	29015	1021	29107	1069	29123
	11	29004	65	29018	1024	29108	1081	29127
	12	29005	76	29020	1030	29110	1084	29128
	20	29006	77	29021	1033	29111	1087	29129
	25	29032	78	29022	1036	29112	1090	29130
	32	29007	80	29023	1042	29114	1105	29135
	34	29008	81	29024	1045	29115	1108	29136
	35	29009	92	29026	1051	29117	1111	29137
	36	29010	95	29029	1054	29118		
	40	29011	1003	29101	1057	29119		
	41	29012	1006	29102	1060	29120		

euro/m

no partial packaging - 8605 can be covered with customised Alcrom® Plus film on request, with a minimum order of 500 meters €/m

PVC LINE

length 250 cm - pack 20 pcs - H = 70 mm

CO-EXTRUDED PVC (FOAM PVC + RIGID PVC)

ART.

8606	<input type="checkbox"/>	white RAL 9003	29227
	<input type="checkbox"/>	white RAL 9010	29229

euro/m

no partial packaging - 8606 can be covered with customised Alcrom® Plus film on request, with a minimum order of 500 meters €/m

PVC Line 8608 is a skirting board in PVC foam, characterized by a round shape and covered with Alcrom® Plus film. Available in several decors, it can be further customized thanks to the digital printing technology Profilpas Digital System. 8608 can be fixed to the wall with adhesive (like MS 45 or MS 55), nails or special fixing clips. PVC does not absorb water, does not contain formaldehyde, is resistant to shocks, wear (certificate AC3), UV rays and the most common cleaning products for floors and wall coverings.

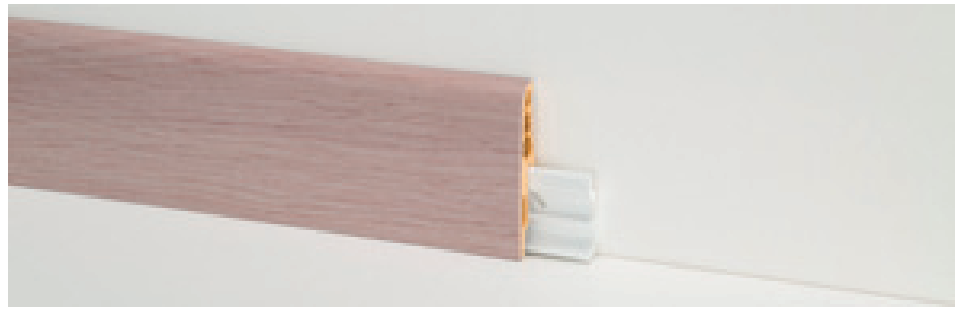

8608 foam PVC covered with Alcrom® Plus film + 8608/C

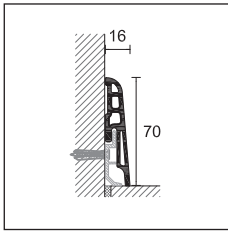

8608



PVC LINE

length = 250 cm - pack 20 pcs

FOAM PVC COVERED WITH ALCROM® PLUS FILM

H = 70 mm

ART.	decors		decors		decors	
		02 29040		32 29047		77 29061
		05 29075		34 29048		78 29062
		08 29041		35 29049		80 29063
		10 29043		36 29050		81 29064
		11 29044		39 29080		89 29081
8608		12 29045		40 29051		91 29082
		14 29076		41 29052		92 29066
		19 29077		44 29053		95 29069
		20 29046		47 29073		96 white RAL 9010 embossed 29070
		26 29078		65 29058		97 black RAL 9005 embossed 29071
		31 29079		76 29060		
euro/m						
8608		99 brushed silver	29083			
		100 brushed steel	29084			
euro/m						

no partial packaging

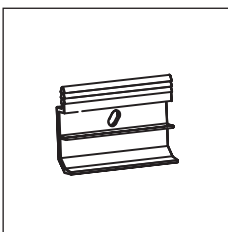

8608/C

FIXING CLIPS FOR ART. 8608

pack of 100 pcs

8608/C

29751

euro/pack



8608 foam PVC covered with Alcrom® Plus film Plus 99 brushed silver

Adhesive for skirting boards see page 249

Customized PDS decors on request for 8608 with a minimum order of 500 meters.

For customizations with decors that are not in our database, there is an extra of € for decor.

skirting board

pvc line

PVC Line 8615 and 8616 are two skirting boards in co-extruded PVC, characterized by a square shape and a 70-mm height. Both are composed of a core in foam PVC and a visible surface in coloured rigid PVC to guarantee the best aesthetic result and colour uniformity. They can also be covered with Alcrom® Plus film and can be further customized thanks to the digital printing technology Profilpas Digital System. 8615 and 8616 can be fixed to the wall with adhesive (like MS 45 or MS 55) or nails. Moreover, they do not absorb water and are resistant to impact, wear and tear, UV rays and the products normally used for cleaning floors and wall coverings.



8615 silver co-extruded PVC

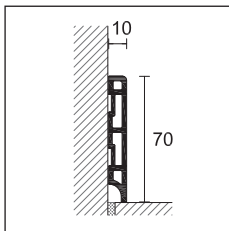

8615

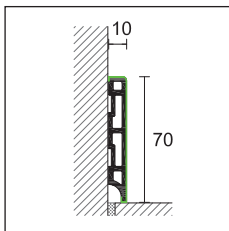

8615 decors with film Alcrom® Plus

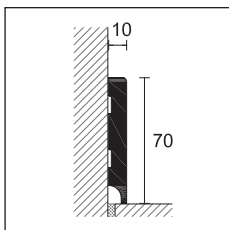

8616

PVC LINE

length 250 cm - pack 20 pcs - H = 70 mm

CO-EXTRUDED PVC (FOAM PVC + RIGID PVC)

ART.

8615	<input type="checkbox"/>	white RAL 9003	29353
	<input type="checkbox"/>	white RAL 9010	29355

euro/m

no partial packaging

PVC LINE

length 250 cm - pack 20 pcs - H = 70 mm

CO-EXTRUDED PVC (FOAM PVC + RIGID PVC) COVERED WITH ALCROM® PLUS FILM

ART. decors

8615	<input type="checkbox"/>	96 white RAL 9010 embossed	29357
	<input checked="" type="checkbox"/>	97 black RAL 9005 embossed	29358

euro/m

no partial packaging

8615 can be covered with customised Alcrom® Plus film on request, with a minimum order of 500 meters €/m

PVC LINE

length 250 cm - pack 20 pcs - H = 70 mm

CO-EXTRUDED PVC (FOAM PVC + RIGID PVC)

ART.

8616	<input type="checkbox"/>	white RAL 9003	29495
------	--------------------------	----------------	-------

euro/m

no partial packaging

8616 can be covered with customised Alcrom® Plus film on request, with a minimum order of 500 meters €/m

Adhesive for skirting boards see page 249

For customizations with decors that are not in our database, there is an extra of € for decor.

PVC Line 8613 is a foam PVC skirting board covered with Alcrom® Plus film, suitable for wooden floors. It can be fixed to the wall with adhesive (like MS 45 or MS 55) or fixing clip 8608/C.



8613 foam PVC covered with Alcrom® Plus film - decor 96

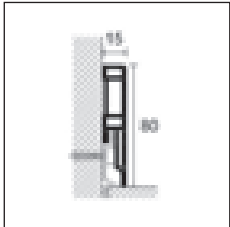

8613

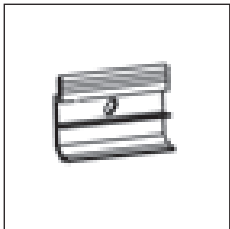

8608/C

PVC LINE

length = 250 cm - pack 20 pcs

FOAM PVC COVERED WITH ALCROM® PLUS FILM

H = 80 mm

ART.	decors		decors	
	05	30060	580	30076
	08	30061	1202	30078
	12	30062	1203	30079
	13	30063	1204	30080
	14	30064	1205	30081
	19	30065	1206	30082
	26	30066	1207	30083
	31	30094	1208	30084
8613	32	30067	1209	30085
	36	30068	1210	30086
	39	30069	1211	30087
	40	30070	1212	30088
	41	30071	1213	30089
	77	30072	1214	30090
	89	30073	1215	30091
	91	30074	1216	30092
	93	30075	1217	30093
	96 white RAL 9010 embossed	29971		
euro/m				
8613	99 brushed silver	29974		
	100 brushed steel	29975		
euro/m				

no partial packaging

FIXING CLIPS FOR ART. 8613

pack of 100 pcs

8608/C
euro/pack

29751

no partial packaging



8613 covered with Alcrom® Plus film - decor 100 brushed steel

Customized PDS decors on request for 8613 with a minimum order of 500 meters.

For customizations with decors that are not in our database, there is an extra of € for decor.

skirting board

pvc line

PVC Line 8612 is a foam PVC skirting board covered with Alcrom® Plus film, suitable for both ceramic and LVT floors. It can be fixed to the wall with adhesive (like MS 45 or MS 55).



8612/10 foam PVC covered with Alcrom® Plus film - decor 96

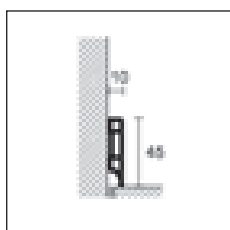

8612/10



PVC LINE

length 250 cm - pack 20 pcs

FOAM PVC COVERED WITH ALCROM® PLUS FILM

H = 45 mm

ART. decors

96 white RAL 9010 embossed 29970

euro/m

8612/10 99 brushed silver 29968

100 brushed steel 29967

euro/m

no partial packaging

PVC Line 8614 is a foam PVC skirting board covered with white Alcrom® Plus film, suitable in case of refurbishment if you want to cover the old skirting boards that are still fixed to the wall. It can be fixed to the old skirting board with adhesive (like MS 45 or MS 55).



8614 foam PVC covered with Alcrom® Plus film - decor 96

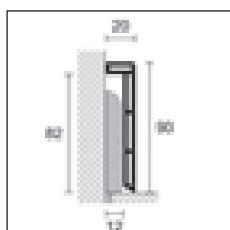

8614



PVC LINE

length = 250 cm - pack 20 pcs

FOAM PVC COVERED WITH ALCROM® PLUS FILM

H = 90 mm

ART. decors

96 white RAL 9010 embossed 29972

euro/m

no partial packaging

8612 and 8614 can be covered with customised Alcrom® Plus film on request, with a minimum order of 500 meters.

For customizations with decors that are not in our database, there is an extra of € for decor.

PVC Line 8600 is a foam PVC skirting board, particularly suitable for DIY installations thanks to its quick and easy application. It is available in different colours and can be fixed with adhesive (like MS 45 or MS 55).

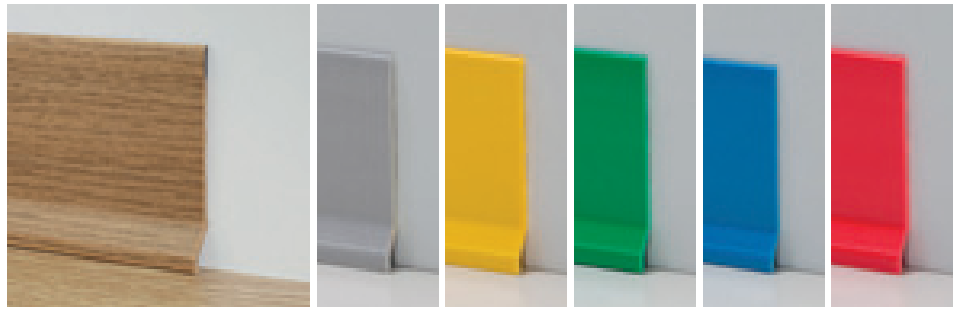

8600 foam PVC decor 532

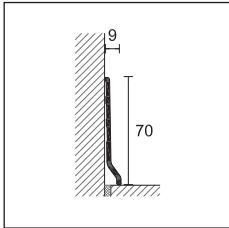

8600



PVC LINE

length 200 cm - pack 20/100 pcs

FOAM PVC

H = 70 mm

ART.	decors		decors		decors		decors	
	518	29762	536	29782	yellow 561	29802	silver 559	29800
	520	29764	540	29784	green 562	29804		
	524	29766	542	29786	light blue 563	29801		
	525	29768	544	29788	red 564	29803		
8600	528	29770	545	29790				
	530	29772	white 555	29792				
	531	29774	light grey 556	29794				
	532	29776	black 557	29796				
	533	29778	anthracite 558	29798				
	534	29780						

pack 20 pcs

euro/m

pack 100 pcs

euro/m

no partial packaging

external corner profiles available in the same decors, see page 45

To order 8600 in pack of 100 pcs mark /100 after the article code (for example 29778 becomes 29778/100).

PVC Line 8181 is a 70 mm high skirting board in plastic-coated PVC, characterized by a special shape that makes it suitable for installation on curved walls. 8181 is particularly suitable for DIY installation, thanks to its quick and easy application. Available in different colours, it must be fixed to the wall with adhesive.



8181 white PVC

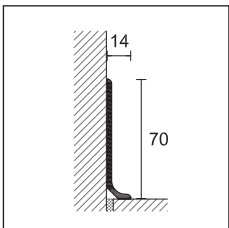

8181



PVC LINE

length = 250 cm - pack 12 pcs

PLASTIC-COATED PVC

H = 70 mm

ART.	decors		
	white		19216
	grey		19217
8181	black		19218

euro/m

no partial packaging

Art. 8181 should be stored horizontally.

skirting board

pvc line

PVC Line 8596 and 8598 are two impact-resistant skirting boards in foam PVC. The upper part resting on the wall and the lower part resting on the floor are in soft material and allow a perfect adhesion even to surfaces that are not perfectly planar, maintaining speed and simplicity of application. They are available in different colours and can be fixed with adhesive (like MS 45 or MS 55).



8596 Foam PVC decor 545

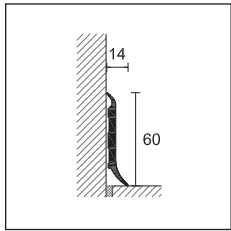

8596



PVC LINE

length = 250 cm - pack 40 pcs

FOAM PVC

H = 60 mm

ART.	decors		decors		decors	
8596		518 30800		531 30812		542 30824
		524 30804		532 30814		545 30828
		525 30806		533 30816		white 555 30830
		528 30808		536 30820		light grey 556 30832
		530 30810		540 30822		black 557 30834

euro/m

no partial packaging

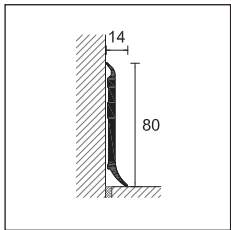

8598

PVC LINE

length = 250 cm - pack 40 pcs

FOAM PVC

H = 80 mm

ART.	decors	
8598		white 555 30880
		light grey 556 30882
		black 557 30884

euro/m

no partial packaging

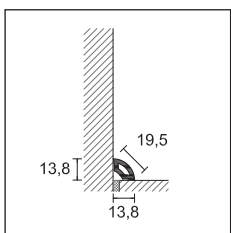

8580

PVC LINE

length = 250 cm - pack 80 pcs

FOAM PVC

ART.	decors		decors	
8580		532 30764		white 555 30780
		542 30774		light grey 556 30782
		545 30778		black 557 30784

euro/m

no partial packaging

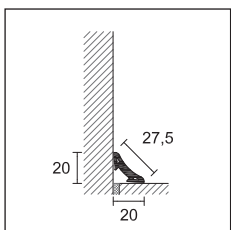

8582

PVC LINE

length = 250 cm - pack 60 pcs

FOAM PVC

ART.	decors		decors	
8582		532 30714		white 555 30730
		542 30724		light grey 556 30732
		545 30728		black 557 30734

euro/m

no partial packaging

PVC Line 8602 is an impact-resistant and 48-mm high skirting board in foam PVC. It is particularly suitable for DIY installation, thanks to the speed and easiness of application. It is available in different colours and it is installed with a simple interlocking system with harmonic steel clips. In addition to their decorative function, it allows to hide the expansion gap perimeter of floating wood and laminate floors.

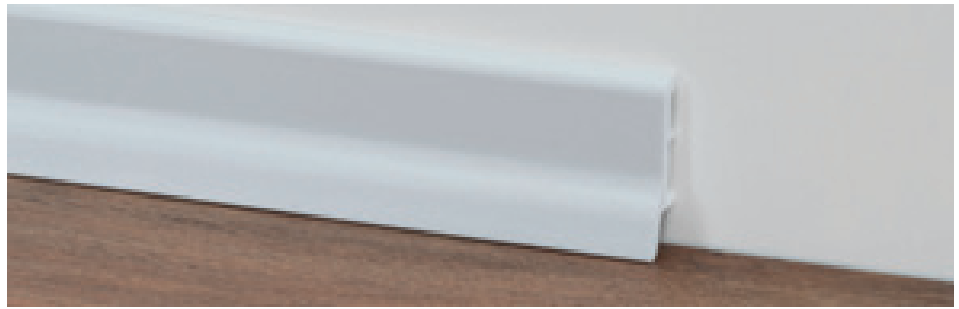

8602 Foam PVC

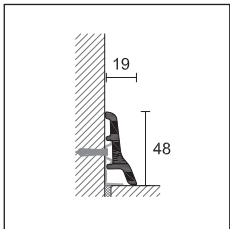

8602





PVC LINE

length 250 cm - pack 40 pcs

FOAM PVC

H = 48 mm

ART.	decors	
8602	 white 555	29530
	 light grey 556	29532
	 black 557	29534

euro/m



no partial packaging

INSIDE CORNER

pack 10 pcs

POLYPROPYLENE

H = 48 mm

ART.	decors	
8602/I	 white 555	29578
	 light grey 556	29580
	 black 557	29582

euro/pc



no partial packaging

OUTSIDE CORNER

pack 10 pcs

POLYPROPYLENE

H = 48 mm

ART.	decors	
8602/E	 white 555	29628
	 light grey 556	29630
	 black 557	29632

euro/pc



no partial packaging

RIGHT/LEFT END CAPS

pack 10 pcs

POLYPROPYLENE

H = 48 mm

ART.	decors	
8602/P dx/sx	 white 555	29728
	 light grey 556	29730
	 black 557	29732

euro/pc

no partial packaging

FIXING CLIPS

10 blister packs / 20 pcs/blister

8602/C 29750

euro/blister

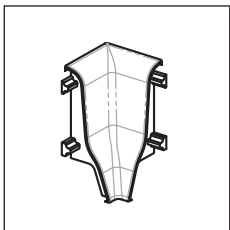

8602/I

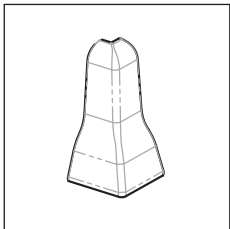

8602/E

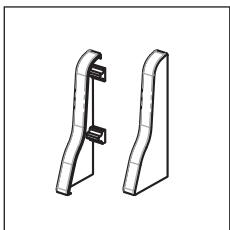

8602/P



8602/C fixing clips

skirting board

pvc line

PVC Line 8603 is an impact-resistant and 70-mm high skirting board in foam PVC. It is particularly suitable for DIY installation, thanks to the speed and easiness of application. It is available in different colours and it can be installed with a simple interlocking system with harmonic steel clips. In addition to its decorative function, it allows to hide the expansion gap perimeter of floating wood and laminate floors.



8603 Foam PVC decor 555

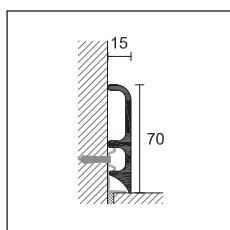

8603



PVC LINE

length 250 cm - pack 40 pcs

FOAM PVC

H = 70 mm

ART.	decors	
8603	 532	30144
	 542	30154
	 545	30158
	 white 555	30160
	 light grey 556	30162
	 black 557	30164

euro/m

no partial packaging

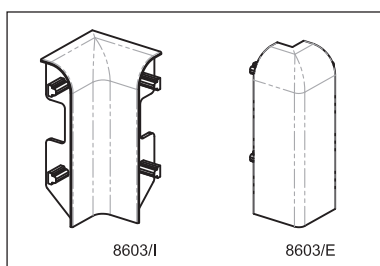

8603/I

8603/E

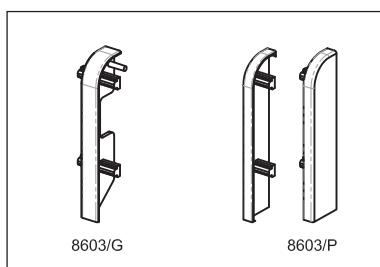

8603/G







8603/P

INSIDE CORNER

pack 10 pcs

POLYPROPYLENE

H = 70 mm

ART.	decors	
8603/I	 532	30194
	 542	30204
	 545	30208
	 white 555	30210
	 light grey 556	30212
	 black 557	30214

euro/pc







no partial packaging

OUTSIDE CORNER

pack 10 pcs

POLYPROPYLENE

H = 70 mm

ART.	decors	
8603/E	 532	30244
	 542	30254
	 545	30258
	 white 555	30260
	 light grey 556	30262
	 black 557	30264

euro/pc







no partial packaging

JUNCTION

pack 10 pcs

POLYPROPYLENE

H = 70 mm

ART.	decors	
8603/G	 532	30294
	 542	30304
	 545	30308
	 white 555	30310
	 light grey 556	30312
	 black 557	30314

euro/pc







no partial packaging

RIGHT/LEFT END CAPS

pack 10 pcs

POLYPROPYLENE

H = 70 mm

ART.	decors	
8603/P dx/sx	 532	30344
	 542	30354
	 545	30358
	 white 555	30360
	 light grey 556	30362
	 black 557	30364

euro/pc

no partial packaging



8602/C fixing clips

FIXING CLIPS

10 blister packs / 20 pcs/blister

8602/C

29750

euro/blister

PVC Line 8607 is an impact-resistant and 70-mm high skirting board in foam PVC. It is particularly suitable for DIY installation, thanks to the speed and easiness of application. It is available in different colours and it can be installed with a simple interlocking system with harmonic steel clips. In addition to its decorative use, it allows to hide the expansion gap perimeter of floating wood and laminate floors.



8607 Foam PVC decor 532

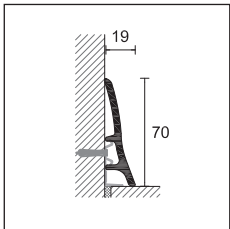

8607



PVC LINE

length 250 cm - pack 40 pcs

FOAM PVC

H = 70 mm

ART.	decors	
8607	532	30414
	542	30424
	545	30428
	white 555	30430
	light grey 556	30432
	black 557	30434

euro/m

no partial packaging

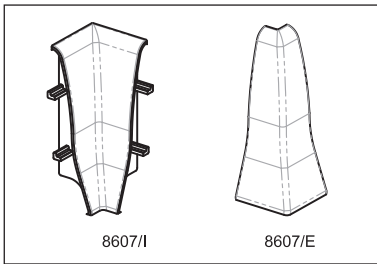

8607/I

8607/E

INSIDE CORNER

pack 10 pcs

POLYPROPYLENE

H = 70 mm

ART.	decors	
8607/I	532	30464
	542	30474
	545	30478
	white 555	30480
	light grey 556	30482
	black 557	30484

euro/pc

no partial packaging

OUTSIDE CORNER

pack 10 pcs

POLYPROPYLENE

H = 70 mm

ART.	decors	
8607/E	532	30514
	542	30524
	545	30528
	white 555	30530
	light grey 556	30532
	black 557	30534

euro/pc

no partial packaging

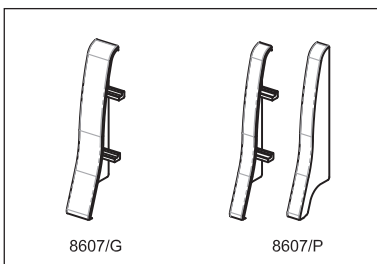

8607/G

8607/P

JUNCTION

pack 10 pcs

POLYPROPYLENE

H = 70 mm

ART.	decors	
8607/G	532	30564
	542	30574
	545	30578
	white 555	30580
	light grey 556	30582
	black 557	30584

euro/pc

no partial packaging

RIGHT/LEFT END CAPS

pack 10 pcs

POLYPROPYLENE

H = 70 mm

ART.	decors	
8607P dx/sx	532	30614
	542	30624
	545	30628
	white 555	30630
	light grey 556	30632
	black 557	30634

euro/pc

no partial packaging



8602/C fixing clips

FIXING CLIPS

10 blister packs / 20 pcs/blister

8602/C

29750

euro/blister

skirting board

pvc line

PVC Line 148 is a skirting board for carpet and PVC coverings, composed of a base in rigid PVC and clip in soft PVC. Used as internal corner connection profile, it creates a curvature on the corner once the covering has been laid. It also allows to finish and cover the extremities of the carpet or the PVC covering, thus covering any cutting inaccuracies. This profile is recommended for public spaces such as hospitals and schools.



172 PVC white

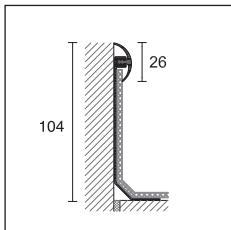

148/B +
148/C

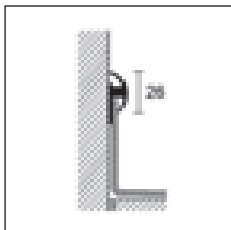

148/BR +
148/C

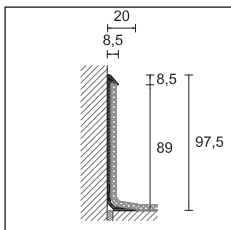

172

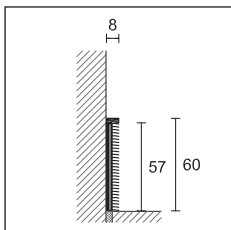

173

PVC LINE - BASE

length = 300 cm - pack 30 pcs

ART. finishing

WHITE RIGID PVC

148/B	PVC white	<input type="checkbox"/>	19095
	<i>euro/m</i>		
148/BR	PVC white	<input type="checkbox"/>	19094
	<i>euro/m</i>		

no partial packaging

PVC LINE - CLIP

length = 305 cm - pack 30 pcs

ART. finishing

PVC MORBIDO

148/C	PVC white	<input type="checkbox"/>	19096
	PVC ash grey	<input type="checkbox"/>	19097
	PVC sand	<input type="checkbox"/>	19098
	<i>euro/m</i>		

no partial packaging

PVC LINE

length = 300 cm - pack 20 pcs

ART. finishing **100**

PVC

172	PVC white	<input type="checkbox"/>	19210
	<i>euro/m</i>		

no partial packaging

length = 300 cm - pack 20 pcs

ART. finishing **60**

ALUMINIUM

173	silver anodised drilled	<input type="checkbox"/>	19215
	<i>euro/m</i>		

no partial packaging

ADHESIVE

Cartridges 12 pcs - 300 ml (MS 45) and 290 ml (MS 55)

ART.

MAPEFLEX MS 45	white	<input type="checkbox"/>	6PB010043
MAPEFLEX MS 55	white	<input type="checkbox"/>	6PV010043

For further information, please see Mapei price list.

148/C is available in different colours on request

PVC Line 170, 169 and 171 are cove-shaped connection profiles in plastic-coated PVC. Recommended for the laying of carpet and PVC coverings, they even out the curvature between the floor and the wall.



171 black PVC

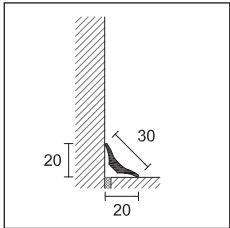

170



PVC LINE - COVE-SHAPED

length = 200 cm - pack 50 pcs

H

ART. finishing

20

PVC

170 black
euro/m

19200

no partial packaging

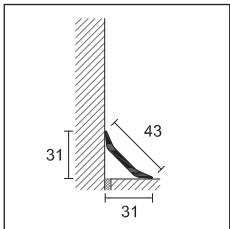

169

PVC LINE - COVE-SHAPED

length = 200 cm - pack 50 pcs

H

ART. finishing

31

PVC

169 black
euro/m

19195

no partial packaging

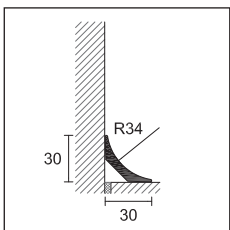

171

PVC LINE - COVE-SHAPED

length = 200 cm - pack 30 pcs

H

ART. finishing

30

PVC

171 black
euro/m

19205

no partial packaging





prolight

Prolight is a line of light profiles with direct and indirect lighting. The integration of the LED technology with Profilpas profiles allows to customize every space. Available in warm, neutral or RGB light and provided with dimmer, they are easy to install and give the suitable light for each use, from the spaces for relaxation to work ones.

Prolight Prolist LLA and LLB are two aluminium decorative listellos with direct LED light. Suitable for framing mirrors and walls and illuminating recessed niches and shelves, these profiles add value to the space, finding an ideal location in bathrooms, kitchens and private space in general. Prolight Prolist LLA/20/10, in particular, is perfect for shower recessed niches to create pleasant plays of light.



LLA/20/10 silver anodised aluminium

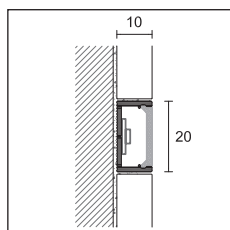

LLA/20



PROLIGHT PROLIST

length = 270 cm - pack 10 pcs **LxH**

ART. finishing **20x10**

ALUMINIUM

LLA/20 silver anodised  **84070**
euro/m

individually packed

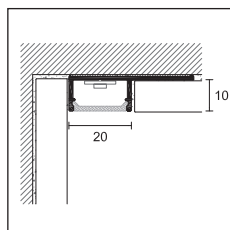

LLA/20/10

PROLIGHT PROLIST

length = 270 cm - pack 10 pcs **H**

ART. finishing **10**

ALUMINIUM

LLA/20/10 silver anodised  **84076**
euro/m

individually packed

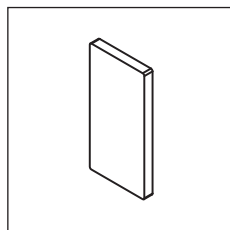

LLA/20P

END CAPS FOR LLA/20 AND LLA/20/10

pack 5 pcs

ART. finishing

ALUMINIUM

LLA/20P silver anodised  **84072**
euro/pc

no partial packaging

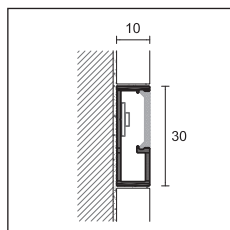

LLA/30
LLB/30

PROLIGHT PROLIST

length = 270 cm - pack 10 pcs **LxH**

ART. finishing **30x10**

ALUMINIUM

LLA/30 silver anodised  **84080**
euro/m

LLB/30 bright polished silver  **84081**
euro/m

individually packed

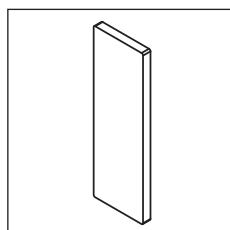

LLA/30P
LLB/30P

END CAPS FOR LLA/30 AND LLB/30

pack 5 pcs

ART. finishing

ALUMINIUM

LLA/30P silver anodised  **84082**
euro/pc

LLB/30P bright polished silver  **84083**
euro/pc

no partial packaging

Spare insert in opaline ABS for art. LLA/20, LLA/20/10, LLA/30 and LLB/30 code 84069 L 270 cm - pack 20 pcs euro/m

For the best aesthetic result and the validity of the warranty, we suggest the exclusive use of our electrical components. See page 236

We recommend the use of NT LED strip with continuous light, see page 236

Prolight Prolist TLA is an aluminium decorative listello with indirect LED light, suitable for framing mirrors or outlining walls and coverings.
Prolight Prolist CLA is ideal under wall cabinets, in kitchens, bathrooms, wardrobes and showcases.

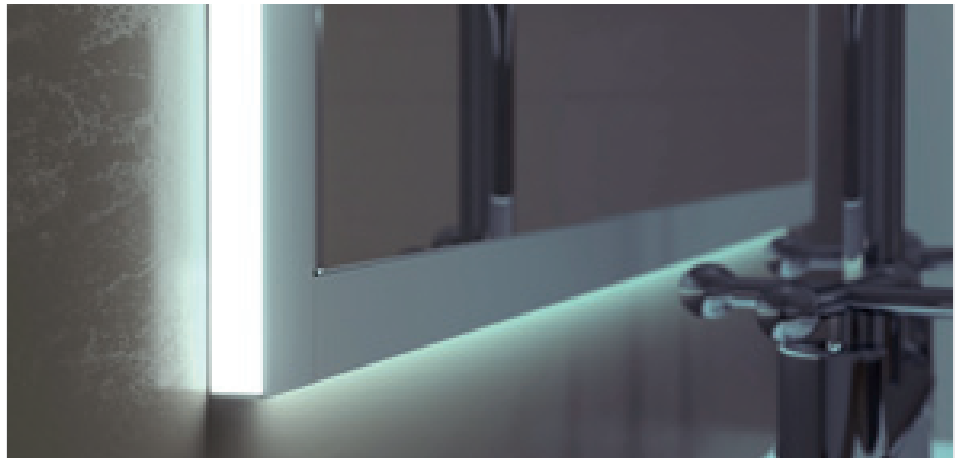

TLA/10/C1 silver anodised aluminium

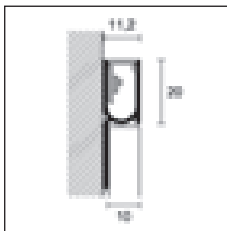

TLA/10/C1
TLB/10/C1



PROLIGHT PROLIST

length = 270 cm - pack 10 pcs

ART.	finishing	LxH
ALUMINIUM		
TLA/10/C1	silver anodised <i>euro/m</i>	84090
TLB/10/C1	bright polished silver <i>euro/m</i>	84091

individually packed

END CAPS FOR TLA/10/C1

pack 5 pcs

ART.	finishing	
ALUMINIUM		
TLA/10P/C1	silver anodised <i>euro/pc</i>	84092
TLB/10P/C1	bright polished silver <i>euro/pc</i>	84093

no partial packaging

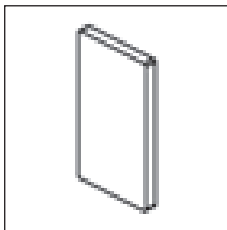

TLA/10P/C1
TLB/10P/C1

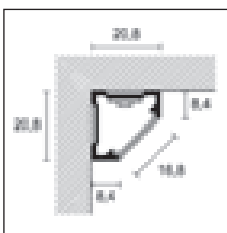

CLA/8
CLA/8A



PROLIGHT PROLIST

length = 270 cm - pack 10 pcs

ART.	finishing	H
ALUMINIUM		
CLA/8	silver anodised <i>euro/m</i>	84221
CLA/8A	silver anodised adesivo <i>euro/m</i>	84222

individually packed

END CAPS FOR CLA/8

pack 5 pcs

ART.	finishing	H
ALUMINIUM		
CLA/8P	silver anodised <i>euro/pc</i>	84223

no partial packaging

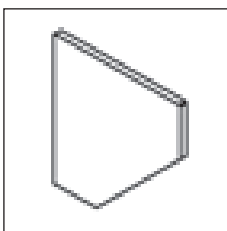

CLA/8P

Spare insert in opaline ABS for art. CLA/8 and CLA/8A code 84069 L 270 cm - pack 20 pcs euro/m

For the best aesthetic result and the validity of the warranty, we suggest the exclusive use of our electrical components. See page 236

We recommend the use of NT LED strip with continuous light, see page 236

Prolight Prolist Q LQL/2 is an aluminium decorative listello with indirect LED light that, thanks to its particular section, creates a delicate and elegant light effect on the ceramic coverings, thus embellishing the wall. This profile is available in a wide range of colours including white stone, five original cement effects, two special metal tonalities and a white characterized by an extremely solid and full colour.



LQL/2 metal light colour-coated aluminium

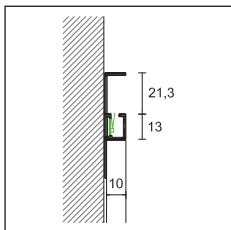

LQL/2



TREND
COLOR

PROLIGHT PROLIST Q

length = 270 cm - pack 5 pcs

H

ART. finishing

10

COLOUR-COATED ALUMINIUM

white stone		84020
concrete white		84021
concrete graphite		84022
concrete smoke		84023
LQL/2 concrete mud		84024
concrete sand		84025
metal dark		84026
metal light		84027
solid white		84028

euro/m

individually packed

ELECTRICAL COMPONENTS AND ACCESSORIES FOR LIGHTING

ART.	description	
L5/NW/65 L	spool 5 m LED strips, lateral light, neutral colour 4000 °K, 9,6W/m IP65	84136
	euro/mt (euro/pack)	

For the best aesthetic result and the validity of the warranty, we suggest the exclusive use of our electrical components. See page 236

Prolight Proangle Q ZQAL is a natural aluminium profile for external corners. Equipped with a diffuser in different colours, it helps increasing safety in public and private spaces through a thin luminous line.

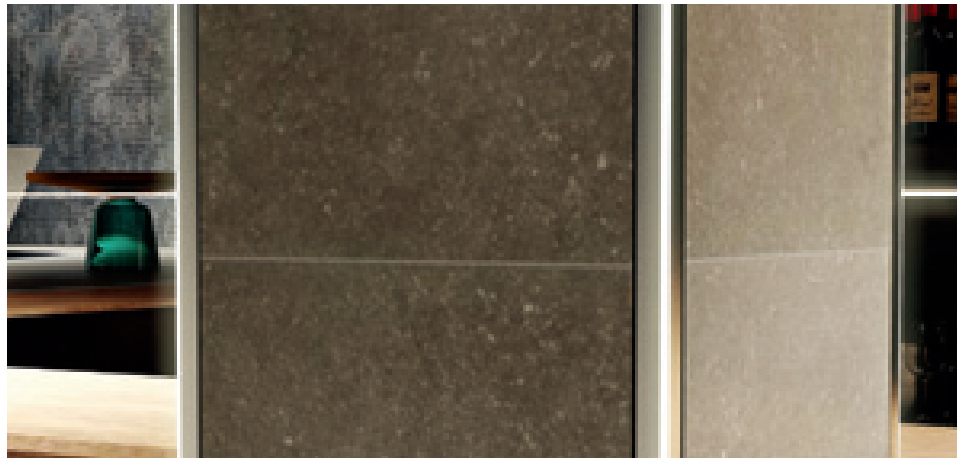

ZQAL/10B natural aluminium + ZQAL/10 white opaline PVC

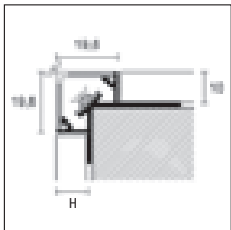

ZQAL/...B+ZQAL/10



PROLIGHT PROANGLE Q

length = 270 cm - pack 10 pcs

		H	
ART.	finishing	10	13
ALUMINIUM			
ZQAL/10B	natural aluminium base	87226	
	<i>euro/m</i>		
ZQAL/13B	natural aluminium base		87227
	<i>euro/m</i>		
OPALINE PVC			
	white		87230
ZQAL/10	grey		87231
	red		87232
	yellow		87233
	<i>euro/m</i>		

Items available in different colours on demand minimum quantity 540 meters

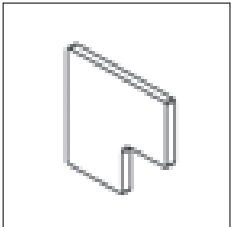

ZQAL/...P

END CAPS FOR ZQAL

pack 5 pcs

		H	
ART.	finishing	10	13
ALUMINIUM			
ZQAL/10P	natural aluminium	87229	
	<i>euro/pc</i>		
ZQAL/13P	natural aluminium		87228
	<i>euro/pc</i>		

no partial packaging

For the best aesthetic result and the validity of the warranty, we suggest the exclusive use of our electrical components. See page 236

We recommend the use of NT LED strip with continuous light, see page 236

cerfix® prostep - protect

Prolight Prostep SGA is an aluminium profile with indirect LED light for the protection and finishing of ceramic, marble and stone steps. With SGA, the light diffuses softly downwards, giving elegance and refinement to the stair, as well as increasing the safety of the space.

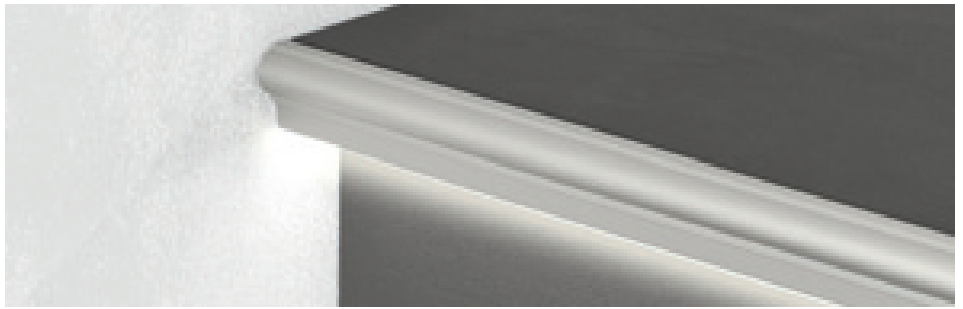

SGA/11L silver anodised aluminium

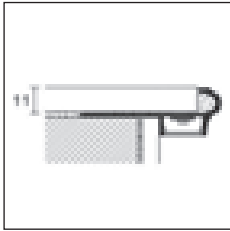

SGA/11L



PROLIGHT PROSTEP

length = 270 cm - pack 10 pcs

H mm

ART. finishing

11

ALUMINIUM

SGA/11L silver anodised
euro/m

94969

individually packed

END CAPS FOR PROFILE SGA/11L

pack 5 pcs

H mm

ART. finishing

11

ALUMINIUM

SGA/11P silver anodised
euro/pc

94964

no partial packaging

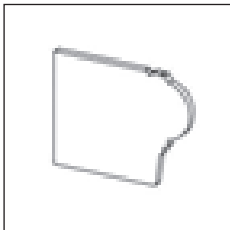

SGA/11P

Prolight Protect G/9 is a stair nosing profile in aluminium equipped with direct LED light and a non-slip knurled surface. G/9 is suitable for public spaces such as cinemas, offices, theatres, clubs and boats, making them welcoming and elegant at the same time.



G/9/SF silver anodised aluminium

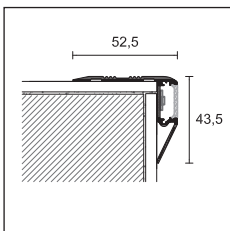

G/9/F



PROLIGHT PROTECT

length = 270 cm - pack 10 pcs

ART. finishing

ALUMINIUM

G/9/F silver anodised
euro/m

84050

individually packed

END CAPS FOR PROFILE G/9/F

pack 5 pcs

ART. finishing

ALUMINIUM

G/9P/DX silver anodised
euro/pc

84052

G/9P/SX silver anodised
euro/pc

84053

no partial packaging

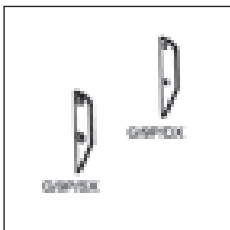

G/9P/

Spare insert in opaline ABS for art. SGA/11L and G/9/F code 84069 L 270 cm - pack 20 pcs euro/m

For the best aesthetic result and the validity of the warranty, we suggest the exclusive use of our electrical components. See page 236

We recommend the use of NT LED strip with continuous light, see page 236

Prolight Protect 126/L/F is an aluminium stair nosing profile equipped with direct LED light and replaceable rubber insert. 126/L/F is suitable for public spaces such as cinemas, offices, theatres, clubs and boards, making them welcoming and elegant at the same time.



126/L/F silver anodised aluminium + GMR/44 black striped rubber

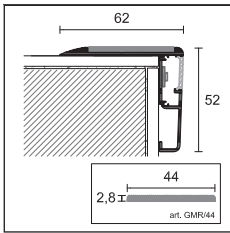

126/L/F



PROLIGHT PROTECT

length = 270 cm - pack 6 pcs

ART. finishing

ALUMINIUM

126/L/F	silver anodised		84060
	<i>euro/m</i>		

individually packed

GROOVED RUBBER

length = 1700 cm - 1 rolls pack

ART.

GMR/44	black		75706
	<i>euro/m</i>		

END CAPS FOR 126/L/F

pack 5 pcs

ART. finishing

ALUMINIUM

126/LP/DX	silver anodised		84062
	<i>euro/pc</i>		

126/LP/SX	silver anodised		84063
	<i>euro/pc</i>		

no partial packaging

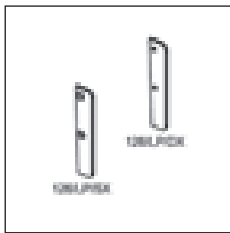

126/LP

Spare insert in opaline ABS for art. 126/L/F code 84069 L 270 cm - pack 20 pcs euro/m

For the best aesthetic result and the validity of the warranty, we suggest the exclusive use of our electrical components. See page 236

We recommend the use of NT LED strip with continuous light, see page 236



metal line S

Prolight Metal Line SKL/2 is a skirting board in aluminium with indirect LED light. Its special section allows to create an original play of light along the wall, thus adding value to the whole surface. In addition to the silver anodised and the white stone versions, SKL/2 is available in 8 finishes: a range of colours including five original cement effects, two special metal tonalities and a white characterized by an extremely solid and full colour.



SKL/2 concrete white colour-coated aluminium

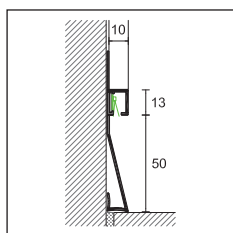

SKL/2



TREND
COLOR

PROLIGHT METAL LINE S

length = 270 cm - pack 5 pcs

H

ART. finishing

10

ALUMINIUM

SKL/2	silver anodised	78579
	<i>euro/m</i>	

COLOUR-COATED ALUMINIUM

SKL/2	white stone	78591
	concrete white	78592
	concrete graphite	78593
	concrete smoke	78594
	concrete mud	78595
	concrete sand	78596
	metal dark	78597
	metal light	78598
	solid white	78599
	<i>euro/m</i>	

individually packed

ELECTRICAL COMPONENTS AND ACCESSORIES FOR LIGHTING

ART.	description	
L5/NW/65 L	spool 5 m LED strips, lateral light, neutral colour 4000 °K, 9,6W/m IP65	84136
	<i>euro/mt (euro/pack)</i>	

For the best aesthetic result and the validity of the warranty, we suggest the exclusive use of our electrical components. See page 236

Metal Line 88/16L/A is a skirting board flush with the wall and with LED lighting system. The light is distributed along the whole length of the profile and passes through a visible gap. There is the possibility to insert the optional dimmer to adjust the light intensity of the skirting board and create both an elegant decoration and a night courtesy light.



88/16L/A silver anodised aluminium

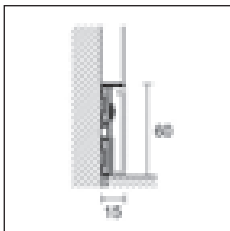

87/6 + 88/16L

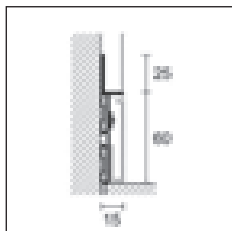

88/6 + 88/16L



88/6E

METAL LINE 87 - 88

length = 200 cm - pack 20 pcs

H cm

ART. finishing

6

ALUMINIUM

87/6 natural aluminium (drilled)



78338

euro/m

88/6 natural aluminium (drilled)



78310

euro/m

individually packed

ALUMINIUM INSERT FOR LED LIGHT

length = 200 cm - pack 20 pcs

H cm

88/16L/A silver anodised



78559

colour-coated matt white



RAL 9010

78560

euro/m

adesivo - individually packed

OUTSIDE CORNER IN METAL

pack 4 pcs

H cm

ART. finishing

6

88/6E silver



78561

colour-coated matt white



RAL 9010

78562

euro/pc

no partial packaging

For the best aesthetic result and the validity of the warranty, we suggest the exclusive use of our electrical components. See page 236

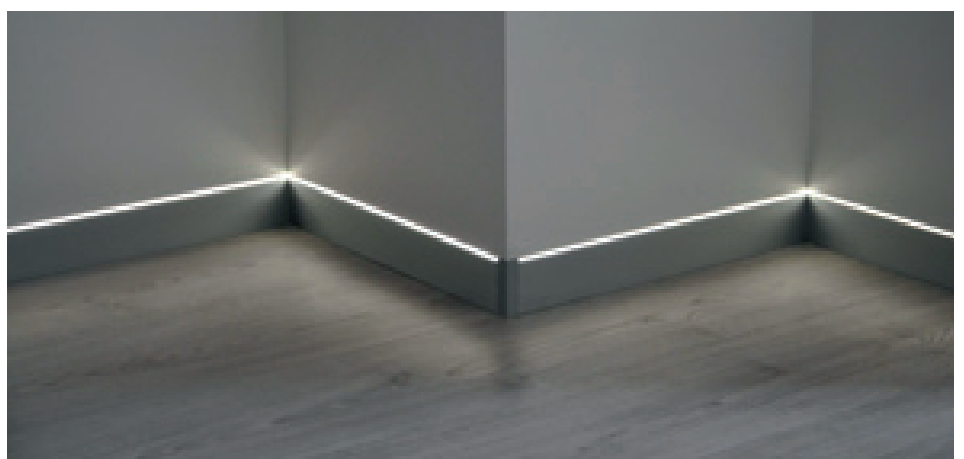

88/6 + 88/16L/A silver anodised aluminium

metal line

Prolight Metal Line 89 is a skirting board in anodised aluminium with LED-strip lighting system. The light is distributed along the entire length of the profile through a diffuser element. It is possible to insert the dimmer in order to adjust the luminous intensity of the skirting board to decorate and light up the room.

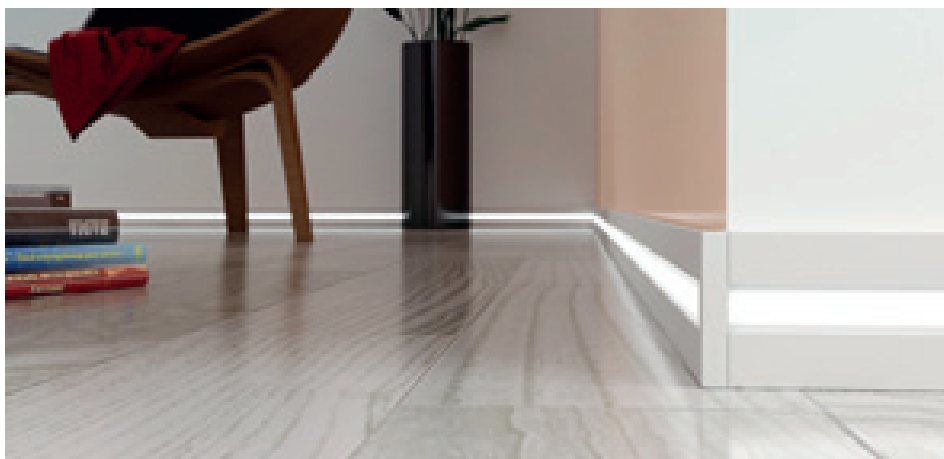

89/6L silver anodised aluminium

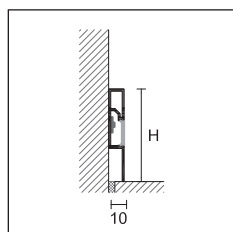

89/6L



PROLIGHT METAL LINE 89

length = 200 cm - pack 25 pcs

H cm

ART. finishing

6

ALUMINIUM

89/6L silver anodised



86000

euro/m

individually packed

INSIDE/OUTSIDE CORNER - RIGHT/LEFT END CAP

pack 4 pcs

H cm

ART. finishing

6

ALUMINIUM

89/6EI silver anodised



78506

euro/pc

no partial packaging



89/6EI

Spare insert in opaline ABS for art. 89/6L code 84069 L 270 cm - pack 20 pcs euro/m

For the best aesthetic result and the validity of the warranty, we suggest the exclusive use of our electrical components. See page 236

We recommend the use of NT LED strip with continuous light, see page 236

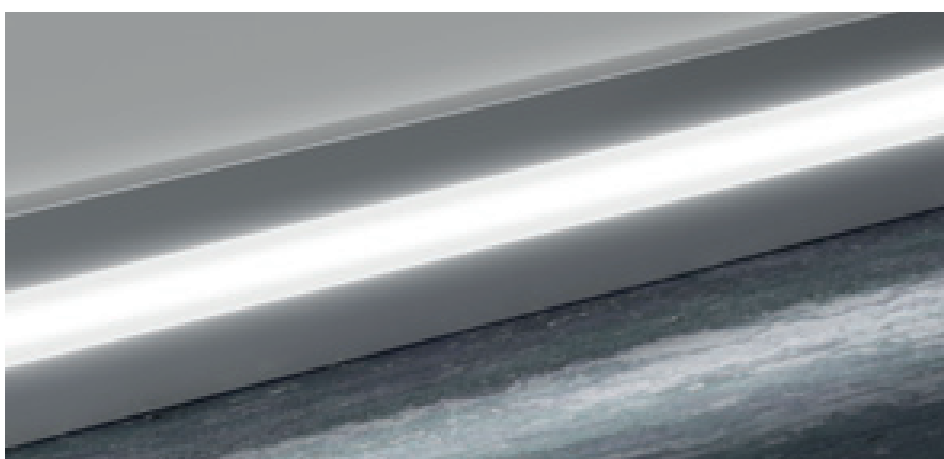

89/6L silver anodised aluminium

HOW TO ORDER THE ELECTRICAL COMPONENTS

LED (white light)

Measure how many meters of LED strip have to be positioned on our profiles. A spool is 5 meters long. Spools have 120 LED every meter. The voltage is 24 volt. The consumption is 9,6 watts every meter. To determine the consumption, length must be multiplied by 9,6 watts.

Example: calculation of the watts consumption = 7,4m x 9,6W = 71 total watts

Choose the colour of the light. LED strips are available in neutral white light (4000 °K) or warm white light (3000 °K).

Choose the degree of protection: IP33 for inside and dry spaces, IP67 for outside or moist spaces.

POWER SUPPLIES

Choose the suitable power supply on the basis of the total watts and so as not to exceed 90% of the maximum power.

Example: 71W : 90 x 100 = 79W - use a power supply of 90W

	ART.		
from 5 cm to 5,5 m	60W	AL/60/24	84150
from 5,6 m to 8,4 m	90W	AL/90/24	84152
from 8,5 m to 11,2 m	120W	AL/120/24	84154
from 11,3 m to 14 m	150W	AL/150/24	84156

We recommend to power the LED strips every 3 meters in order to avoid differences in brightness and the overheating of the LED in the initial part of them. A cable with 1 mm² section has a maximum range of about 4 Amp and a voltage drop of 1 Volt every 10 meters. For special installations, please contact our Technical Department.

DIMMER (optional)

The dimmer/fader/driver has the function to adjust the light intensity of LED light, it supports maximum 10 Amp to an equal extent of 25 linear meters of our LED strip. It must be placed between the power supply and the LED strip and connected to a switch (not supplied) and/or to the receiver of the remote control (optional).

In case of more lines with simultaneous turning on, the first dimmer is connected in Sync mode and it will switch on the consecutive dimmers.

Example: to connect 3 lines with simultaneous turning on, you need to use 3 dimmers.

REMOTE CONTROL + RECEIVER (optional)

The remote control is a radiofrequency and can control up to 4 channels; it is used to turn on/off the LED.

The receiver must be installed between the power supply and the LED strip or connected to the dimmer if present.

If there is also the dimmer, the remote control can adjust the LED light intensity.

ELECTRICAL CABLES

The cables are necessary to connect the power supply to the LED strips where needed.

A cable with 1 mm² section has a maximum range of about 4 amps and a voltage drop of 1 volt every 10 meters.

CONNECTORS

Art. IR/C01 connects the LED strips to the line of power supply.
Art. IR/W3 connects maximum 3 cables among them.

LED RGB (coloured light)

Measure how many meters of LED strip have to be positioned on our profiles. A spool is 5 meters long. Spools can be cut every 10 cm. The voltage is 24 volt. The consumption is 14,4 watts every meter. To determine the consumption, length must be multiplied by 14,4 watts.

Example: calculation of the watts consumption = 7,4m x 14,4W = 106,6 total watts

RGB LED strips are available in degree of protection IP67, are covered with silicone sheath and are provided with adhesive for the fastening in inside or outside spaces.

POWER SUPPLIES

Choose the suitable power supply on the basis of the total watts and so as not to exceed 90% of the maximum power.

Example: 106,60W : 90 x 100 = 118W - use a power supply of 120W

	ART.		
from 10 cm to 3,7 m	60W	AL/60/24	84150
from 3,8 m to 5,5 m	90W	AL/90/24	84152
from 5,6 m to 7,5 m	120W	AL/120/24	84154
from 7,6 m to 9,3 m	150W	AL/150/24	84156

We recommend to power the LED strips every 3 meters in order to avoid differences in brightness and the overheating of the LEDs in the initial part. A cable with 1 mm² section has a maximum range of about 4 amp and a voltage drop of 1 volt every 10 meters. For length over 9,3 meters, see SLAVE paragraph. For special installations, please contact our Technical Department.

REMOTE CONTROL

The remote control is a radiofrequency and can control up to 4 channels; it is used to turn on/off the LED, adjust light intensity and choose the colour or the sequence of LEDs.

MASTER CONTROL UNIT

Connected with the remote control, it is used to turn on/turn off/adjust light intensity and to choose the colour or the sequence of LEDs.

It must be connected between the power supply and the LED strip.

SLAVE CONTROL UNIT

Every time that the system needs more lines controlled by just one unit, there is the need to add 1 slave for every added line.

Example: to connect 3 lines with simultaneous lighting, you need to use 1 master control unit and 2 slave control units.

The slave control unit must be connected to the master control unit with RJ11 6-poles cable (not supplied).

ELECTRICAL CABLES

The cable has 4 poles, 3 of them have a 0,5 mm² section (for the three colours), one of them has a 1 mm² section (for the negative pole).

CONNECTORS

Art. IR/C02 connects the LED strips with coloured light to the line of power supply, length of 15 cm.
Art. IR/C03 connects LED strips to LED strips with coloured light, length of 15 cm.

We recommend to assign the assembly of the electrical components to qualified staff.

Electrical components and accessories for Prolight profiles. Each element has to be chosen depending on the established length of the light profiles. It is necessary to calculate the power consumption in W/m for choosing one or more power supplies to be combined with the dimmer and the controller.



spool 5 m NT LED strip



L5/.../33



L5/.../67



AL/.../24

DIMM/02



TEL/04



TEL/RGB/04



RIC/01

ELECTRICAL COMPONENTS AND ACCESSORIES FOR LIGHTING

ART.	description	
L5/NW/33	spool 5 m LED strip colour neutral white 4000° K - 9,6W/m - IP33 <i>euro/m (euro/pack)</i>	84105
L5/WW/33	spool 5 m LED strip colour warm white 3000° K - 9,6W/m - IP33 <i>euro/m (euro/pack)</i>	84115
L5/NW/67	spool 5 m LED strip colour neutral white 4000° K - 9,6W/m - IP67 <i>euro/m (euro/pack)</i>	84125
L5/WW/67	spool 5 m LED strip colour warm white 3000° K - 9,6W/m - IP67 <i>euro/m (euro/pack)</i>	84135
L5/RGB/67	spool 5 m RGB LED strip - 14,4 W/m - IP67 <i>euro/m (euro/pack)</i>	84140
L5/NW/65NT	spool 5 m NT LED strip neutral white colour 4000° K - 10W/m - IP65 <i>euro/m (euro/pack)</i>	84118
L5/NW/67NT	spool 5 m NT LED strip neutral white colour 4000° K - 10W/m - IP67 <i>euro/m (euro/pack)</i>	84122
AL/60/24	power supply IP67 - PFC active - 24Vdc/60W <i>euro/pc</i>	84150
AL/90/24	power supply IP67 - PFC active - 24Vdc/90W <i>euro/pc</i>	84152
AL/120/24	power supply IP67 - PFC active - 24Vdc/120W <i>euro/pc</i>	84154
AL/150/24	power supply IP67 - PFC active - 24Vdc/150W <i>euro/pc</i>	84156
DIMM/02	dimmer/driver 24V/10 Amp - dim. mm 57x44x19 h. for white LED light <i>euro/pc</i>	84187
TEL/04	4- channel radio frequency remote control <i>euro/pc</i>	84182
RIC/01	4- remote control receiver radio frequency <i>euro/pc</i>	84184
TEL/RGB/04	4 channel radiofrequency remote control 433,92MHz for RGB LED diam. 80x13 h <i>euro/pc</i>	84183



RIC/RGB/...



CE/5/20
CE/10/...



CE/RGB/20

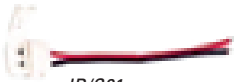

IR/C01

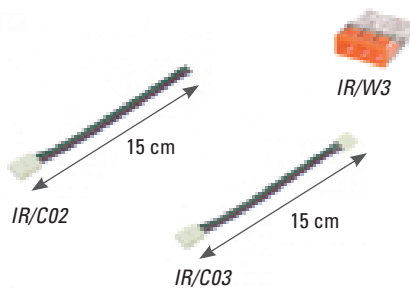

IR/W3

IR/C02

IR/C03

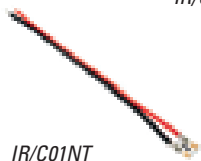

IR/C01NT



IR/C01NT

RIC/RGB/M	master control unit with dimmer functiona/wireless for RGB LED diam. 174x46x35 h euro/pc	84185
RIC/RGB/S	slave control unit whit dimmer function for RGB LED (maximum 4 slave for each master) euro/pc	84186
CE/5/20	electrical cable sect. 0,5 mm ² - pack 20 ml euro/m	84420
CE/10/20	electrical cable sect. 1 mm ² - pack 20 ml euro/m	84422
CE/10/100	electrical cable sect. 1 mm ² - pack 100 ml euro/m	84424
CE/RGB/20	electrical cable for RGB LED section 3x0,5 mm ² + 1x1 mm ² - pack 20 m euro/m	84426
IR/C01	rapid fit connector for strip LED white light - pack 10 pcs euro/pc	84411
IR/W3	rapid fit connector 3 cables - pack 10 pcs euro/pc	84410
IR/C02	rapid fit connector RGB LED strip - pack 10 pcs euro/pc	84415
IR/C03	rapid fit double connector RGB LED strip - pack 10 pcs euro/pc	84416
IR/C01NT	rapid fit connector for NT LED strip white light - pack 10 pcs euro/pc (euro/pack)	84413





entrance mats

Promat is a modular technical mat designed for both public and private use. Thanks to its easy assembly with a simple interlocking system, Promat does not need specific expertise and can be assembled directly on site. Promat is available in three insert solutions: carpet, brushes or rubber. In this way, it guarantees the cleaning and the protection of floors against dust, filth in general and water.

promat

Promat is a modular technical mat, which can be customized and created in any size directly on site, allowing maximum operational flexibility.

The installation of Promat is easy and quick thanks to the interlocking system with silver anodised aluminium profiles, already equipped with inserts in black carpet, rubber or brushes. The carpet insert, recommended for internal use, absorbs finer dirt and water, and also aids drying when passing through.

The rubber insert is resistant to atmospheric agents, making it ideal for outdoor use, removes coarse dirt and also has a non-slip function. Lastly, the brushes insert is suitable for outdoor installation in area of high pedestrian traffic thanks to its ability to remove the most difficult dirt.

Promat can be installed recessed or overlapped on existing floors according to the needs. In case of overlapping installation, there is the possibility to insert the ramp profile for facilitating the access.

Promat is also available in two already-assembled and ready-for-use versions in a choice of carpet or rubber/brush mix, in sizes 70x39,5 cm and 90x49,5 cm.



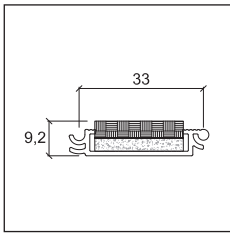

ZT/307/MN

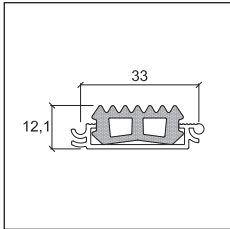

ZT/307/GN

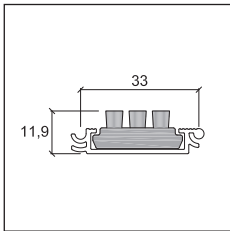

ZT/307/SN

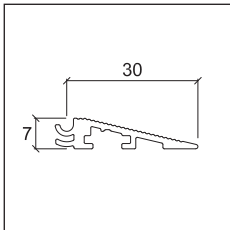

ZT/307/R1

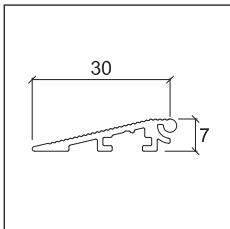

ZT/307/R2

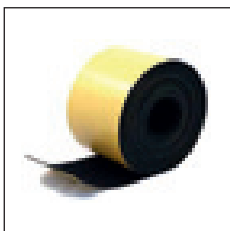

ZT/307/NA

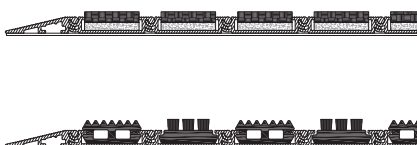

PROMAT

length = 270 cm - pack 10 pcs

ART.			Conf.
ZT/307/MN	silver anodised aluminium profile + black carpet insert	90400	10
	<i>euro/m</i>		
ZT/307/GN	silver anodised aluminium profile + black rubber insert	90401	10
	<i>euro/m</i>		
ZT/307/SN	silver anodised aluminium profile + black brushes insert	90402	10
	<i>euro/m</i>		
ZT/307/R1	silver anodised aluminium right ramp profile	90403	10
	<i>euro/m</i>		
ZT/307/R2	silver anodised aluminium left ramp profile	90404	10
	<i>euro/m</i>		

individually packed

ACCESSORIES

length = 500 cm - pack 1 pc

ART.			Conf.
ZT/307/NA	adhesive tape in black EPDM 5 m	90405	1
	<i>euro/m (euro/rotolo)</i>		

no partial packaging

PROMAT - READY-MADE MAT

ART.			Conf.
ZT/307/01	ready-made mat dim. 70x39,5 cm with profiles with black carpet inserts	90407	1
	<i>euro/pc</i>		
ZT/307/02	ready-made mat dim. 70x39,5 cm with profiles with black rubber and brushes inserts	90408	1
	<i>euro/pc</i>		
ZT/307/03	ready-made mat dim. 90x49,5 cm with profiles with black carpet inserts	90409	1
	<i>euro/pc</i>		
ZT/307/04	ready-made mat dim. 90x49,5 cm with profiles with black rubber and brushes inserts	90410	1
	<i>euro/pc</i>		



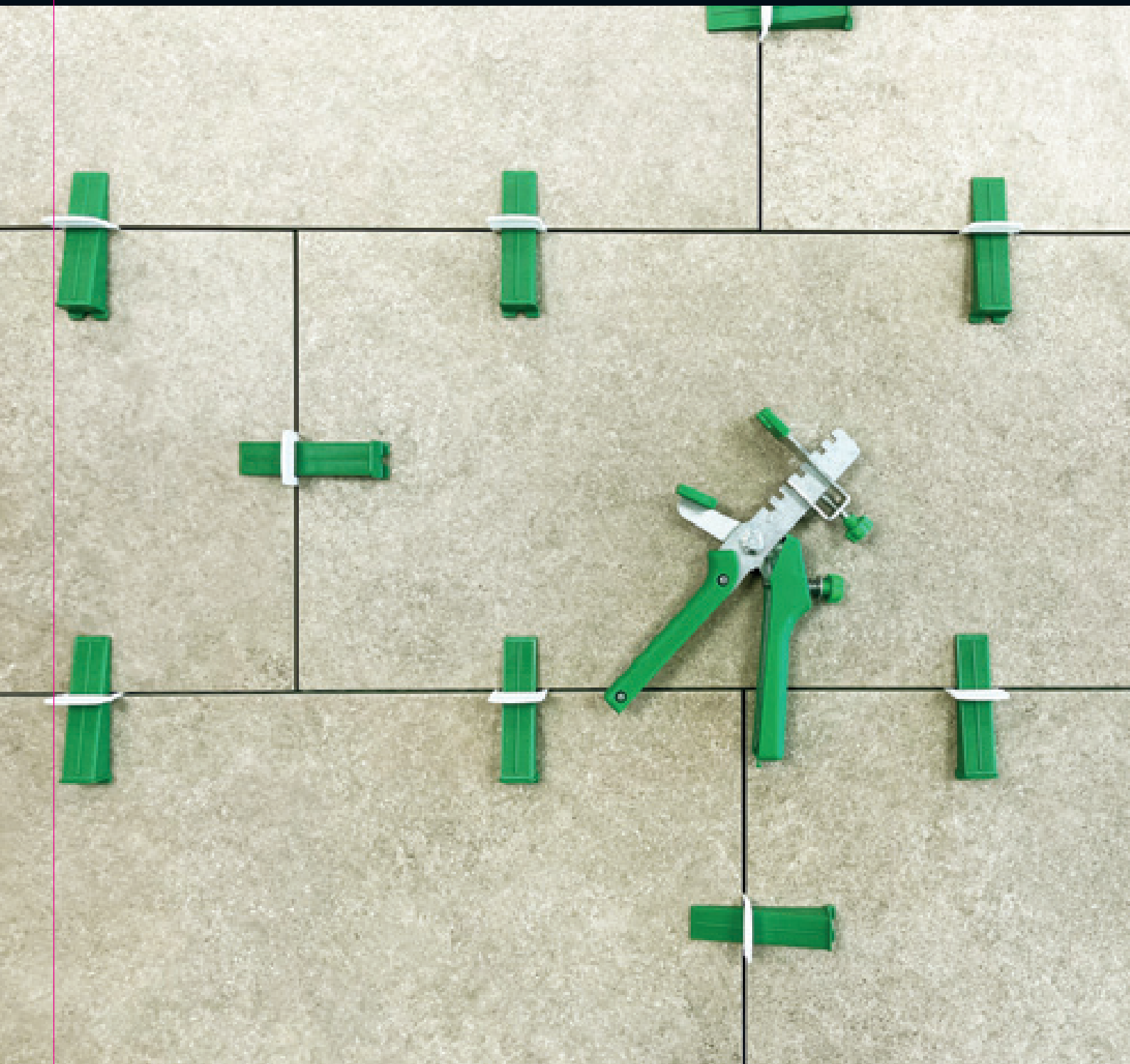

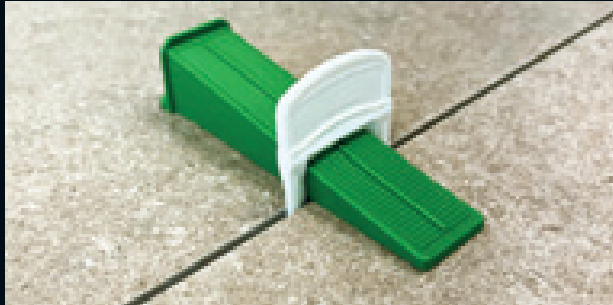

accessories for installation

Adhesives, utensils, systems
and accessories.

Protiler is a levelling system for the laying of ceramic and stone tiles. It is suitable for thicknesses from 3 to 20 mm and impedes the vertical movement between tiles during the adhesive grip phase. Specific pliers are available for the laying of floors and coverings for less effort and saving time.



Protiler



disposable clips installation



tiles laying

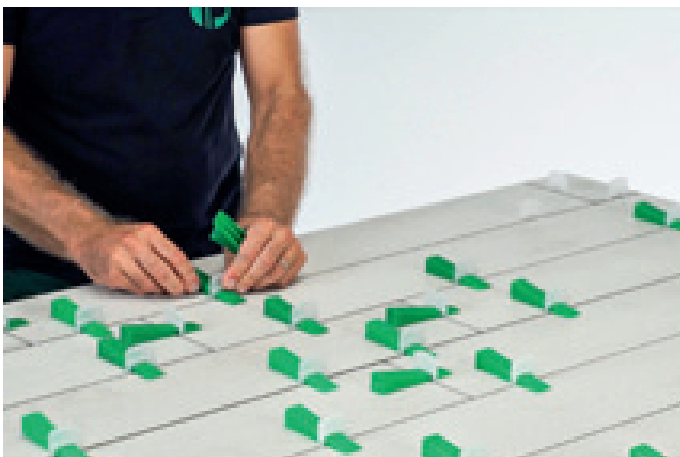

levelling wedges insertion

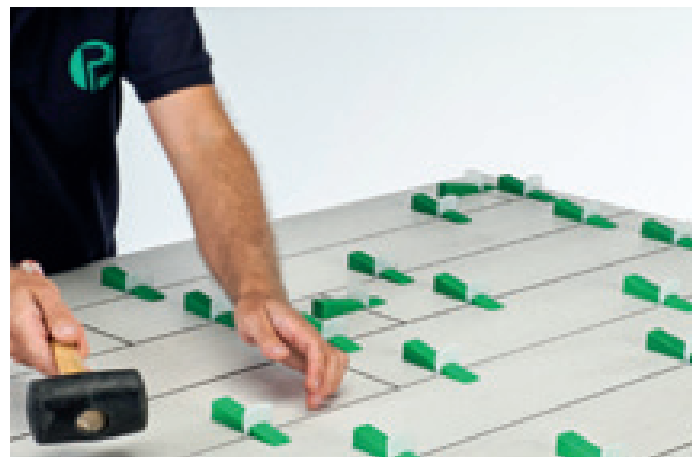

wedges and clips removal

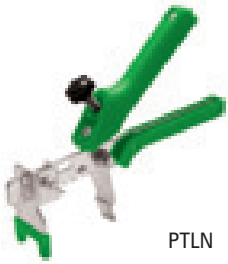

PTLN



PROTILER

pack 10 pcs

ART.

PTLN	adjustable traction pliers <i>euro/pc (euro/pack)</i>	18067
-------------	--	-------

no partial packaging

LEVELLING WEDGES

pack 14 bags with 100 pcs

pallet

ART.

PTWN	levelling wedges <i>euro/pc (euro/bag)</i>	18063	210 bags
-------------	---	-------	----------

pack 1400 pcs

pallet

ART.

PTWN/1400	levelling wedges <i>euro/pc (euro/pack)</i>	18076	15 packs
------------------	--	-------	----------

no partial packaging



PTWN

DISPOSABLE CLIPS

pack 12 bags with 250 pcs

pallet

ART.

PTC	clips for 0,5 mm grouts and tile thicknesses from 3 to 12 <i>euro/pc (euro/bag)</i>	18070	180 bags
------------	--	-------	----------

PTC1	clips for 1 mm grouts and tile thicknesses from 3 to 12 <i>euro/pc (euro/bag)</i>	18071	180 bags
-------------	--	-------	----------

PTC1A	clips for 1,5 mm grouts and tile thicknesses from 3 to 12 <i>euro/pc (euro/bag)</i>	18075	180 bags
--------------	--	-------	----------

PTC2	clips for 2 mm grouts and tile thicknesses from 3 to 12 <i>euro/pc (euro/bag)</i>	18072	180 bags
-------------	--	-------	----------

PTC3	clips for 3 mm grouts and tile thicknesses from 3 to 12 <i>euro/pc (euro/bag)</i>	18073	180 bags
-------------	--	-------	----------

pack 60 bags with 50 pcs

pallet

ART.

PTC4/1	clips for 1 mm grouts and tile thicknesses from 12 to 20 mm <i>euro/pc (euro/bag)</i>	18082	600 bags
---------------	--	-------	----------

PTC4	clips for 2 mm grouts and tile thicknesses from 12 to 20 mm <i>euro/pc (euro/bag)</i>	18074	600 bags
-------------	--	-------	----------

PTC4/3	clips for 3 mm grouts and tile thicknesses from 12 to 20 mm <i>euro/pc (euro/bag)</i>	18084	600 bags
---------------	--	-------	----------

PTC4/5	clips for 5 mm grouts and tile thicknesses from 12 to 20 mm <i>euro/pc (euro/bag)</i>	18085	600 bags
---------------	--	-------	----------

pack 3000 pcs

pallet

ART.

PTC/3000	clips for 0,5 mm grouts and tile thicknesses from 3 to 12 <i>euro/pc (euro/pack)</i>	18077	15 packs
-----------------	---	-------	----------

PTC1/3000	clips for 1 mm grouts and tile thicknesses from 3 to 12 <i>euro/pc (euro/pack)</i>	18078	15 packs
------------------	---	-------	----------

PTC1A/3000	clips for 1,5 mm grouts and tile thicknesses from 3 to 12 <i>euro/pc (euro/pack)</i>	18079	15 packs
-------------------	---	-------	----------

PTC2/3000	clips for 2 mm grouts and tile thicknesses from 3 to 12 <i>euro/pc (euro/pack)</i>	18080	15 packs
------------------	---	-------	----------

PTC3/3000	clips for 3 mm grouts and tile thicknesses from 3 to 12 <i>euro/pc (euro/pack)</i>	18081	15 packs
------------------	---	-------	----------

no partial packaging

BUCKET

pack 15 pcs

pack

ART.

PTS	9.1 L bucket for accessories dim. cm 28x19x23 h. <i>euro/pc (euro/pack)</i>	18069	15 pcs
------------	--	-------	--------

no partial packaging



PTS

Fix Level is a screw levelling system for floors and coverings of different thickness, particularly suitable for large size tiles.

The cylinder incorporates a disk for the protection of the covering surface against scratches during the levelling phase.



Fix Level



FLM/C



FLM/S



KLM/10

KLM/15

KLM/20

KLM/30

KLM/50

CYLINDER

pack 16 bags with 50 pcs

Pallet

ART.

FLM/C	cylinder <i>euro/pc (euro/bag)</i>	18090	12 boxes
-------	---------------------------------------	-------	----------

no partial packaging

ANTI-SCRATCH DISK

pack 35 bags with 50 pcs

ART.

FLM/S	anti-scratch disk <i>euro/pc (euro/bag)</i>	18091	
-------	--	-------	--

no partial packaging

DISPOSABLE SCREW SPACER

pack 25 bags with 100 pcs

Pallet

ART.

KLM/10	screw for 1-mm grouts and tile thicknesses from 3 to 21 mm <i>euro/pc (euro/bag)</i>	18093	12 boxes
KLM/15	screw for 1,5-mm grouts and tile thicknesses from 3 to 21 mm <i>euro/pc (euro/bag)</i>	18094	12 boxes
KLM/20	screw for 2-mm grouts and tile thicknesses from 3 to 21 mm <i>euro/pc (euro/bag)</i>	18095	12 boxes
KLM/30	screw for 3-mm grouts and tile thicknesses from 3 to 21 mm <i>euro/pc (euro/bag)</i>	18096	12 boxes
KLM/50	screw for 5-mm grouts and tile thicknesses from 3 to 21 mm <i>euro/pc (euro/bag)</i>	18097	12 boxes

no partial packaging

DISPOSABLE T-SCREW SPACER

pack 25 bags with 100 pcs

Pallet

ART.

KLM/T10	T-screw for 1-mm grouts and tile thicknesses from 3 to 21 mm <i>euro/pc (euro/bag)</i>	18098	12 boxes
KLM/T15	T-screw for 1,5-mm grouts and tile thicknesses from 3 to 21 mm <i>euro/pc (euro/bag)</i>	18099	12 boxes
KLM/T20	T-screw for 2-mm grouts and tile thicknesses from 3 to 21 mm <i>euro/pc (euro/bag)</i>	18100	12 boxes
KLM/T30	T-screw for 3-mm grouts and tile thicknesses from 3 to 21 mm <i>euro/pc (euro/bag)</i>	18101	12 boxes

no partial packaging

DISPOSABLE CROSS SCREW SPACER

pack 25 bags with 100 pcs

Pallet

ART.

KLM/X10	cross screw for 1-mm grouts and tile thicknesses from 3 to 21 mm <i>euro/pc (euro/bag)</i>	18102	12 boxes
KLM/X15	cross screw for 1,5-mm grouts and tile thicknesses from 3 to 21 mm <i>euro/pc (euro/bag)</i>	18103	12 boxes
KLM/X20	cross screw for 2-mm grouts and tile thicknesses from 3 to 21 mm <i>euro/pc (euro/bag)</i>	18104	12 boxes
KLM/X30	cross screw for 3-mm grouts and tile thicknesses from 3 to 21 mm <i>euro/pc (euro/bag)</i>	18105	12 boxes

no partial packaging

Klic Level is a screw levelling system for floors and coverings of different thickness, particularly suitable for large size tiles. The cylinder incorporates a disk for the protection of the covering surface against scratches during the levelling phase, and a functional mechanism for a rapid insertion and expulsion of the disposable element.



Klic Level



KLM/C

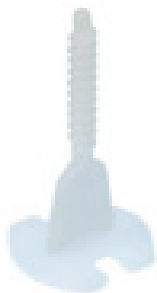

KLM/10
KLM/15
KLM/20
KLM/30
KLM/50

CYLINDER

pack 10 bags with 50 pcs **Pallet**

ART.			
KLM/C	cylinder with anti-scratch disk	18092	12 boxes

no partial packaging

DISPOSABLE SCREW SPACER

pack 25 bags with 100 pcs **Pallet**

ART.			
KLM/10	screw for 1-mm grouts and tile thicknesses from 3 to 21 mm	18093	12 boxes
	<i>euro/pc (euro/bag)</i>		
KLM/15	screw for 1,5-mm grouts and tile thicknesses from 3 to 21 mm	18094	12 boxes
	<i>euro/pc (euro/bag)</i>		
KLM/20	screw for 2-mm grouts and tile thicknesses from 3 to 21 mm	18095	12 boxes
	<i>euro/pc (euro/bag)</i>		
KLM/30	screw for 3-mm grouts and tile thicknesses from 3 to 21 mm	18096	12 boxes
	<i>euro/pc (euro/bag)</i>		
KLM/50	screw for 5mm grouts and tile thicknesses from 3 to 21 mm	18097	12 boxes
	<i>euro/pc (euro/bag)</i>		

no partial packaging

DISPOSABLE T-SCREW SPACER

pack 25 bags with 100 pcs **Pallet**

ART.			
KLM/T10	T-screw for 1-mm grouts and tile thicknesses from 3 to 21 mm	18098	12 boxes
	<i>euro/pc (euro/bag)</i>		
KLM/T15	T-screw for 1,5-mm grouts and tile thicknesses from 3 to 21 mm	18099	12 boxes
	<i>euro/pc (euro/bag)</i>		
KLM/T20	T-screw for 2-mm grouts and tile thicknesses from 3 to 21 mm	18100	12 boxes
	<i>euro/pc (euro/bag)</i>		
KLM/T30	T-screw for 3-mm grouts and tile thicknesses from 3 to 21 mm	18101	12 boxes
	<i>euro/pc (euro/bag)</i>		

no partial packaging

DISPOSABLE CROSS SCREW SPACER

pack 25 bags with 100 pcs **Pallet**

ART.			
KLM/X10	cross screw for 1-mm grouts and tile thicknesses from 3 to 21 mm	18102	12 boxes
	<i>euro/pc (euro/bag)</i>		
KLM/X15	cross screw for 1,5-mm grouts and tile thicknesses from 3 to 21 mm	18103	12 boxes
	<i>euro/pc (euro/bag)</i>		
KLM/X20	cross screw for 2-mm grouts and tile thicknesses from 3 to 21 mm	18104	12 boxes
	<i>euro/pc (euro/bag)</i>		
KLM/X30	cross screw for 3-mm grouts and tile thicknesses from 3 to 21 mm	18105	12 boxes
	<i>euro/pc (euro/bag)</i>		

no partial packaging

Plastic cross and T spacers used in the installation of floors and wall coverings for creating uniform and precise grout lines. They are available for thicknesses up to 10 mm and are suitable for both inside and outside spaces. Both spacers are compliant with UNI 11493-1 standard (methods for the correct installation of ceramic tiles).

Plastic wedges used for recovering small differences in height during tile installation.



Cross spacers

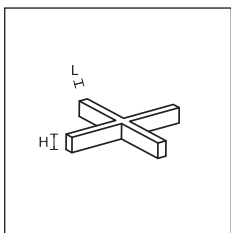

DC



CROSS SPACERS

	box with 10 packs of 500 pcs					box with 20 packs of 250 pcs	
LxH	1x5	2x5	3x5	4x5	5x5	7x6	10x8
ART.	DC1 solid	DC2 solid	DC3 drilled	DC4 drilled	DC5 drilled	DC7 drilled	DC10 drilled
	18992	19002	19008	19014	19020	19024	19030
euro/pack							

no partial packaging

T SPACERS

	box with 10 packs of 500 pcs					box with 20 packs of 250 pcs	
LxH	1x5	2x5	3x5	4x5	5x5	7x6	10x8
ART.	DT1 solid	DT2 solid	DT3 drilled	DT4 drilled	DT5 drilled	DT7 drilled	DT10 drilled
	19038	19042	19048	19054	19060	19064	19070
euro/pack							

no partial packaging

WEDGES

pack	box with 20 packs of 250 pcs	box with 10 packs of 500 pcs
LxH	9x28x5	9x28x5
ART.	CN28	CN28
	19080	19082
euro/pack		

no partial packaging

CROSS SPACER FOR OUTDOOR USE

pack 2 bags with 50 pcs

ART.		
DCE4	cross spacer for outdoor tiles and 4-mm grouts	19076
	euro/pc (euro/bag)	

no partial packaging

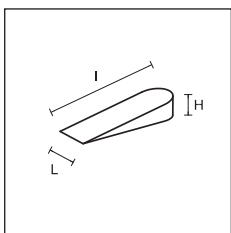

DT

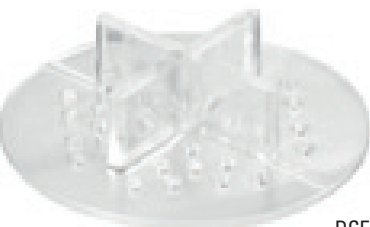

DCE4



T Spacers



Wedges



skirting board adhesive

ADHESIVE

Cartridges 12 pcs - 300 ml (MS 45) and 290 ml (MS 55)

ART.

MAPEFLEX MS 45	white	<input type="checkbox"/>	6PB010043
MAPEFLEX MS 55	white	<input type="checkbox"/>	6PV010043

For further information, please see Mapei price list.

MAGNETIC KIT

box with 10 blisters

K10	00410
------------	-------

euro/blister



polishing paste

POLISHING PASTE FOR METAL PROFILE CLEANING

pack 20 pcs - quantity 150 ml

POLISHING PASTE	30018
------------------------	-------

euro/pc



doubled sided adhesive tapes

DOUBLED SIDED ADHESIVE TAPES

	POLYPROPYLENE	COTTON CLOTH
pack	24	24
LxL cm	5x2500	5x2500
ART.	D/4461/K	D/4471/K
	30004	30014
<i>euro/pc</i>		



SCREWS

	FLAT HEAD				ROUND HEAD	
box - 1000 pcs						
finishing	nickel-plated	brass plated	bronze plated	brass plated	nickel-plated	brass plated
LxL mm	3X25	3X25	3X25	3X25	3,5X25	3,5X25
ART.	SS/5	SS/5	SS/5	RR/5	SS/4	SS/4
	68800	68801	68802	68803	68804	68805
<i>euro/box</i>						

proflex line

Proflex machine is a machine designed and built to model the profiles with curvilinear shape of the proflex line produced by Profilpas. The machine contains a proper kit and more kits are available in case you need to bend the PLAF or Metal Line 90.



PROFLEX MACHINE - hand machine to bend proflex line profiles



kit 30052

PROFLEX MACHINE

ART.	description	
proflex	hand machine to bend profiles inside and outside	30022
	<i>euro/pc</i>	
30052	wheels kit for metal line flex 90/	30052
	<i>euro/pc</i>	

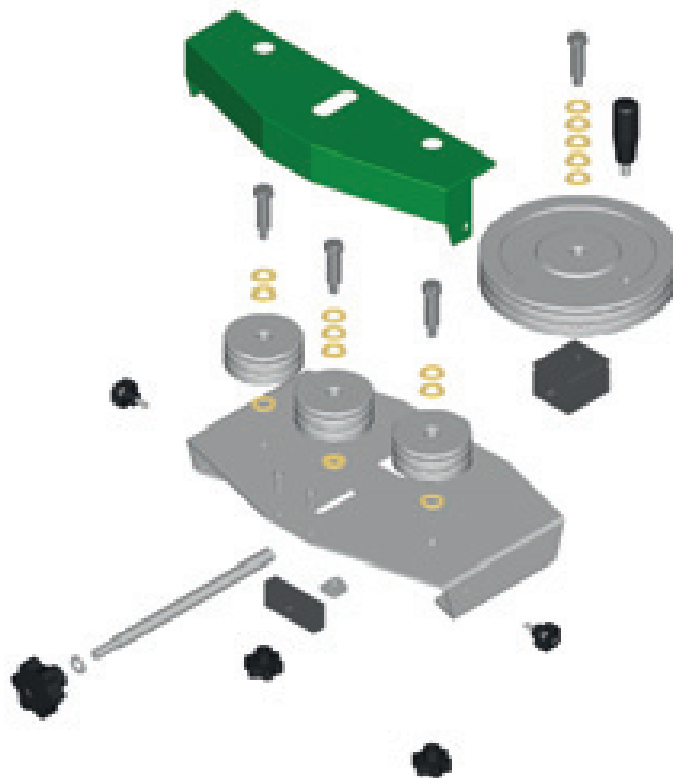

DIY profiles

A wide range of DIY profiles in aluminium, stainless steel and brass, available in many measures. Suitable to solve professional and bricolage works.





profiles in anodised aluminium

		with barcode label				
		length m. 1		length m. 2		
		measures	silver	euro/pc	silver	euro/pc
flat		12x2	10100		10104	
		15x2	10108		10112	
		20x2	10116		10120	
		25x2	10124		10128	
		30x2	10132		10136	
		40x2	-	-	-	-
		50x2	-	-	-	-
		60x2	-	-	-	-
corner		10x10x1	10140		10144	
		15x15x1	10148		10152	
		20x20x1*	10156		10160	
		25x25x1*	10164		10168	
		30x30x1*	10172		10176	
		30x30x1,5	-	-	09020	
		40x40x1,5	10380		10384	
		40x40x2	-	-	-	-
		50x50x2	-	-	-	-
corner L		15x10x1	10180		10184	
		20x10x1	10188		10192	
		30x15x1	10196		10200	
U profile		8x8x1	10204		10208	
		10x10x1	10212		10216	
		10x15x1	10220		10224	
		12x12x1	-	-	10218	
double U profile		16x7x1	-	-	10232	
		16x12x1	10236		10240	
		20x10x1	-	-	10248	
		20x18x1	10252		10256	
edge trim		18x1	10260		10264	
		22x1	10268		10272	
		25x1	10276		10280	
round tube		8x1	09032		09036	
		10x1	09040		09044	
		12x1	09048		09052	
		15x1	10284		10288	
		18x1	10292		10296	
		20x1	10300		10304	
		25x1,5	-	-	09060	
square tube		10x10x1	10308		10312	
		15x15x1	10316		10320	
		20x20x1	10324		10328	
rectangular tube		20x10x1	10332		10336	
		30x15x1	10340		10344	
T profile		15x15x1,5	10348		10352	
		25x25x1,5	10356		10360	
round bar		Ø 6	-	-	09084	
		Ø 8	10364		10368	
		Ø 10	-	-	09092	
square bar		8x8	10372		10376	
		10x10	-	-	10394	

Articles no partial packaging. Pack. 10 pcs per item - Minimum order : 100 assorted pcs DIY range.







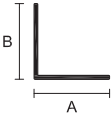
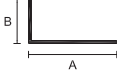
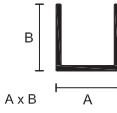

* items available also 3 m long without barcode pag 253

EAN 13 = the first group product code

example code 10395 = 8010937 10395



profiles in anodised aluminium

		without barcode label				
		length m. 2		length m. 3		
		silver	euro/pc	silver	euro/pc	
flat		measures				
		12x2	510104	-	-	
		15x2	510112	-	-	
		20x2	510120	-	-	
		25x2	510128	-	-	
		30x2	510136	-	-	
		40x2	510095	510096		
		50x2	510099	510097		
corner		10x10x1	510144	-	-	
		15x15x1	510152	-	-	
		20x20x1	510160	510158		
		25x25x1	510168	510166		
		30x30x1	510176	510174		
		30x30x1,5	509020	-	-	
		40x40x1,5	510384	-	-	
		40x40x2	510381	510383		
		50x50x2	510382	510387		
		corner L		15x10x1	510184	
20x10x1	510192					
30x15x1	510200					
U profile		8x8x1	510208			
		10x10x1	510216			
		10x15x1	510224			
		12x12x1	510218			
double U profile		16x7x1	510232			
		16x12x1	510240			
		20x10x1	510248			
		20x18x1	510256			
edge trim		18x1	510264			
		22x1	510272			
		25x1	510280			
round tube		8x1	509036			
		10x1	509044			
		12x1	509052			
		15x1	510288			
		18x1	510296			
		20x1	510304			
square tube		25x1,5	509060			
		10x10x1	510312			
		15x15x1	510320			
		20x20x1	510328			
rectangular tube		20x10x1	510336			
		30x15x1	510344			
T profile		15x15x1,5	510352			
		25x25x1,5	510360			
round bar		Ø 6	509084			
		Ø 8	510368			
		Ø 10	509092			
square bar		8x8	510376			
		10x10	510394			

Articles no partial packaging. Pack. 10 pcs per item - Minimum order : 100 assorted pcs DIY range.







EAN 13 = the first group product code

example code 10395 = 8010937 10395

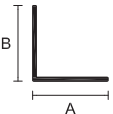
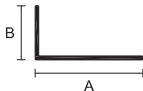
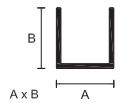

profiles in anodised and colour-coated aluminium

with barcode label
length m. 2

	measures	gold anodised	titanium anodised	colour-coated white RAL 9003	<i>euro/pc</i>
flat	 12x2	10105	-	-	
	15x2	10113	-	11612	
	20x2	10121	10470	11620	
	30x2	10137	-	11636	
corner	 10x10x1	10145	10452	11644	
	15x15x1	10153	10454	11652	
	20x20x1	10161	10456	11660	
	25x25x1	10169	10458	11668	
	30x30x1	10177	-	11676	
	40x40x1,5	10385	-	11684	
corner L	 15x10x1	10185	10462	11692	
	20x10x1	10193	10464	11700	
	30x15x1	10201	10466	11708	
U profile	 8x8x1	10209	-	-	
	10x10x1	-	-	11724	
	10x15x1	10225	-	-	
double U profile	 20x18x1	-	-	11764	
edge trim	 18x1	10265	-	11772	
	22x1	10273	-	-	
	25x1	10281	-	-	
round tube	 10x1	09045	-	-	
	15x1	-	-	11796	
	18x1	10297	-	-	
	20x1	10305	-	-	
square tube	 10x10x1	-	-	11820	
rectangular tube	 20x10x1	10337	-	11844	
T profile	 15x15x1,5	-	-	11860	
	25x25x1,5	-	-	11868	

Articles no partial packaging. Pack. 10 pcs for gold items, 5 pcs for titanium items



Minimum order: 100 assorted pcs DIY range.

EAN 13 = the first group product code

example code 10395 = 8010937 10395

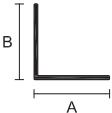
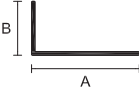
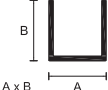

profiles in bright polished silver aluminium

		with barcode label			
		length m. 1		length m. 2	
	measures	silver	euro/pc	silver	euro/pc
flat 	15x2	-	-	10115	
	20x2	-	-	10123	
	25x2	-	-	10131	
corner 	10x10x1	10143		10147	
	15x15x1	10151		10155	
	20x20x1	10159		10163	
	25x25x1	-	-	10171	
	30x30x1	-	-	10179	
corner L 	15x10x1	-	-	10186	
	20x10x1	-	-	10195	
	30x15x1	-	-	10203	
U profile 	10x10x1	-	-	10219	
	10x15x1	-	-	10227	
	12x12x1	-	-	10211	
edge trim 	18x1	-	-	10267	
T profile 	15x15x1,5	10351		10355	

Pack. 5 pcs per article

Minimum order: 100 assorted pcs DIY range.



polished brass and stainless steel corners

with barcode label

length m. 2

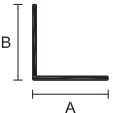
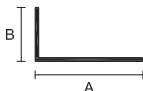
corner	measures	polished brass	<i>euro/pc</i>	stainless steel	<i>euro/pc</i>
	15x15x1	10002		10050	
	20x20x1	10006		10054	
	25x25x1	-	-	10058	
	30x30x1	10014		10062	
	40x40x1	-	-	10070	
	15x10x1	10030		-	-
	20x10x1	10034		10082	
	30x10x1	-	-	10086	

Articles no partial packaging.

Pack. 5 pcs per article - Minimum order: 100 assorted pcs DIY range.

EAN 13 = the first group product code

example code 10094 = 8010937 10094

curtain counterweights in silver anodised aluminium with rounded edges

	measures	length m. 1		length m. 2		length m. 4	
		cod.	<i>euro/pc</i>	cod.	<i>euro/pc</i>	cod.	<i>euro/pc</i>
	30x4 boxes pcs 10	10604		10605		10606	
	40x4 boxes pcs 10	10608		10609		-	-

Articles no partial packaging.

EAN 13 = the first group product code

example code 10824 = 8010937 10824

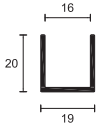
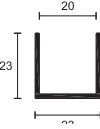
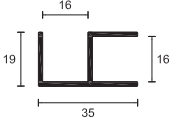
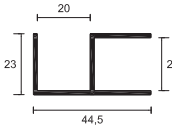
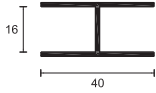

silver anodised aluminium profiles for structures

				with barcode label					
				length m. 2		length m. 3			
				measures	thickness	cod.	euro/pc	cod.	euro/pc
U profile		for panels frame thickness up to 16 mm Packaging 6 pcs per item.	16	1,5	10500		10504		
U profile		for panels frame thickness up to 20 mm Packaging 6 pcs per item.	20	1,5	10532		10536		
double U profile		for 90° corners between panel boards thickness up to 16 mm Packaging 6 pcs per item.	16	1,5	-	-	10512		
double U profile		for 90° corners between panel boards thickness up to 20 mm Packaging 6 pcs per item.	20	1,5	-	-	10544		
H profile		for connection of panels thickness up to 16 mm Packaging 6 pcs per item.	16	1,5	-	-	10520		



Design is our best profile.

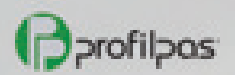

Design is our best profile.





Design is our best profile.

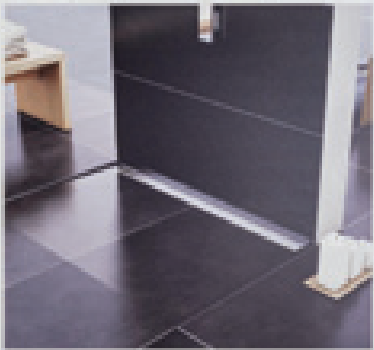

Design is our best profile.



merchandising for the point of sale

A series of tools dedicated to the showroom: modular expositive pieces of furniture, counter display boxes, sampleboards, sample boxes, cylinders etc for creating suitable areas for every need of space and products.



Profilpas concept store: a modular display system composed of panels that can be used singularly or combined together. For each panel, there is the possibility to choose the display units according to the products treated.



self-supporting base for panels

PANEL 1 terrace picture DIM. CM 90X220 H.	02036 €
PANEL 2 living room picture DIM. CM 90X220 H.	02037 €
PANEL 3 bathroom picture DIM. CM 90X220 H.	02038 €
PANEL 4 staircase picture DIM. CM 90X220 H.	02039 €
PANNELLO 5 pp drain aqua bathroom picture DIM. CM 90X220 H.	02080 €
SELF-SUPPORTING BASE FOR PANELS	02040 €
DISPLAY UNIT 1 - CPGV+CPQV+MAPEGUARD UM 35	02041 €
DISPLAY UNIT 2 - CPNV+CPCV/30	02042 €
DISPLAY UNIT 3 - SNG+SIR+SIG+SIS+SP+76	02043 €
DISPLAY UNIT 4 - GIN+ILN+ZQIN	02044 €
DISPLAY UNIT 5 - ZQVN Trend Color Stone	02045 €
DISPLAY UNIT 6 - SLIM DRAIN+GLASS PROFILE	02046 €
DISPLAY UNIT 7 - SMART DRAIN	02047 €
DISPLAY UNIT 8 - THIN DRAIN	02048 €
DISPLAY UNIT 9 - case for sample boards (without sample boards)	02049 €
DISPLAY UNIT 10 - 8605+8608	02055 €
DISPLAY UNIT 11 - PP LEVEL DUO MAXI	02064 €
DISPLAY UNIT 7/a - shelf only	02056 €
DISPLAY 12 - PP DRAIN AQUA CLASSIC BRUSHED STEEL + GLASS PROFILE BRUSHED STEEL	02067 €
DISPLAY 13 - PP DRAIN AQUA FLAT BLACK ALUMINIUM + GLASS PROFILE BRUSHED STEEL	02068 €
DISPLAY 14 - SHELF FOR 2 FLAT COVER AND 1 DESIGN COVER OF YOUR CHOICE (covers not included to be ordered separately)	02069 €
DISPLAY 15 - SHELF FOR 3 FLAT COVER OF YOUR CHOICE (covers not included to be ordered separately)	02070 €
DISPLAY 16 - Q DRAIN CLASSIC POLISHED STEEL + TILE	02071 €

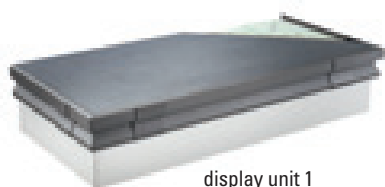

display unit 1
CPGV + CPQV + UM 35

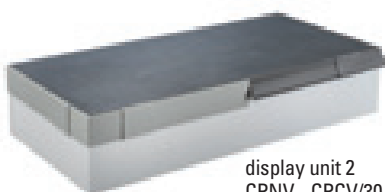

display unit 2
CPNV - CPCV/30



display unit 3
SNG + SIR + SGI +
SIS + SP - 76

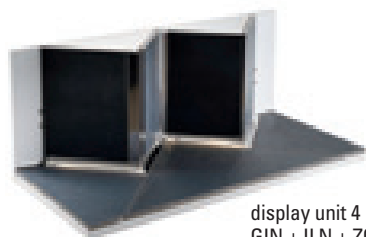

display unit 4
GIN + ILN + ZQIN

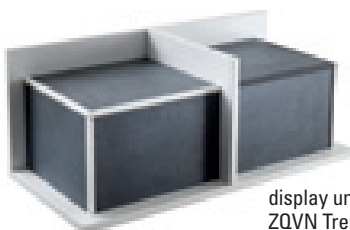

display unit 5
ZQVN Trend
Color Stone

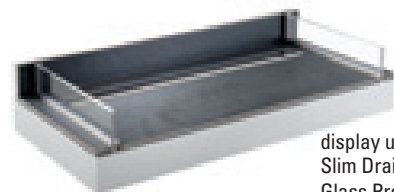

display unit 6
Slim Drain +
Glass Profile



display unit 7
Smart Drain



display unit 8
Thin Drain



display unit 9
case for sample boards



display unit 10
8605 - 8608



display unit 11
PP level DUO MAXI



display unit 7/A
shelf only



display unit 12
PP Drain Aqua Classic Cover + Glass Profile



display unit 13
PP Drain Aqua Flat Cover + Glass Profile



display unit 14
Flat Cover + Design Cover

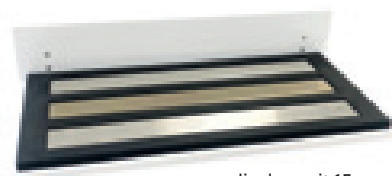

display unit 15
Flat Cover



display unit 16
Q Drain Classic + Tile



black totem for sample boards dim. cm 55x55x200 h	02034	€
white totem for sample boards dim. cm 55x55x200 h.	02035	€



counter display for 4 sample boards	00273	€
-------------------------------------	-------	---

Exhibition panels divided for different application categories.
They are also suitable for inclusion in the drawer corner shop.







sampleboard 1	PROLIST decorative listellos and profiles	02015	€
sampleboard 2	external corners profiles PROTRIM	02016	€
sampleboard 3	external corners profiles PROANGLE Q	02017	€
sampleboard 4	external corners profiles PROCORNER internal corners profiles PROROUND	02018	€
sampleboard 5	profiles for small gaps	02019	€
sampleboard 6	profiles for floors of same height	02020	€
sampleboard 7	profiles for floors of different height	02021	€
sampleboard 8	profiles for LVT floors	02022	€
sampleboard 9	Expansion joints PROJOINT	02023	€
sampleboard 10	profiles for balconies and terraces PROTEC	02024	€
sampleboard 11	stair nosing profiles	02025	€
sampleboard 12/A	Unisystem plus	02065	€
sampleboard 12/B	prestowood - pvc line	02066	€
sampleboard 13/A	METAL LINE 89-90-790	02057	€
sampleboard 13/B	METAL LINE 87-88-92-93-95-97-98-100	02058	€
sampleboard 14	Trend Color	02028	€
sampleboard 17	PVC Line skirting boards	02078	€

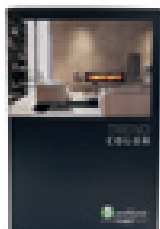
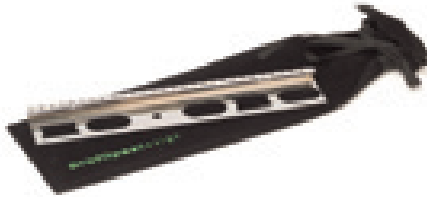

black counter display Trend Color Proangle Q	00193	€
black counter display Trend Color Proangle	00219	€
black counter display Proangle Q	00166	€



cylinder wall profiles	00103	€
cylinder floor profiles	00104	€
cylinder small gaps profiles	00114	€
cylinder proangle Q	00115	€
cylinder unisystem	00080	€
cylinder proline	00127	€
cylinder LVT	00142	€
cylinder proligh	00143	€

	sample DJKC/10	00134	€
	sample DJKC/10	00135	€
	sample UKC/10	00136	€
	sample DJKGC/10	00137	€
	sample UKGC/10	00138	€

brochure trend color IT/EN	00282	€
brochure trend color FR/DE	00283	€
brochure trend color ES/PT	00284	€

brochure profiles and skirting boards for wood and laminate IT/GB	00285	€
brochure profiles and skirting boards for wood and laminate FR/DE	00286	€
brochure profiles and skirting boards for wood and laminate ES/PT	00287	€
brochure profiles and skirting boards for wood and laminate CZ/PL	00290	€

brochure profiles for balconies and terraces IT/GB	00279	€
brochure profiles for balconies and terraces FR/DE	00280	€
brochure profiles for balconies and terraces ES/PT	00281	€
brochure profiles for balconies and terraces CZ/PL	00288	€

brochure promat IT/EN	00305	€/pz
brochure promat FR/DE	00319	€/pz
brochure promat ES/PT	00321	€/pz
brochure promat CZ/PL	00323	€/pz

sample box PROMAT	00349	€
-------------------	-------	---

sample box PROANGLE Q	00351	€
sample box TREND COLOR	00353	€



counter display pp drain aqua - classic cover dim. cm 70x32x30 H. (60 cm cover not included, to be ordered separately)	02072	€
counter display pp drain aqua - flat cover or invisible cover dim. cm 70x32x30 H. (60 cm cover not included, to be ordered separately)	02073	€
counter display pp drain aqua - design cover dim. cm 70x32x30 H. (60 cm cover not included, to be ordered separately)	02074	€

counter display pp drain aqua - classic cover dim. cm 70x32x30 H. (60 cm linear drain and cover not included, to be ordered separately)	02075	€
---	-------	---

counter display pp drain aqua - flat cover or invisible cover dim. cm 70x32x30 H. (60 cm linear drain and cover not included, to be ordered separately)	02076	€
---	-------	---

counter display pp drain aqua - design cover dim. cm 70x32x30 H. (60 cm linear drain and cover not included, to be ordered separately)	02077	€
--	-------	---



sample case PP Drain AQUA	02079	€
---------------------------	-------	---



brochure pp drain aqua IT/GB	00295	€
------------------------------	-------	---

brochure pp drain aqua FR/DE	00296	€
------------------------------	-------	---

brochure pp drain aqua ES/PT	00297	€
------------------------------	-------	---

brochure pp drain aqua CZ/PL	00298	€
------------------------------	-------	---



sample of glass profile in brushed stainless steel	00072	€
--	-------	---

sample of glass profile in matt black colour-coated stainless steel	00078	€
---	-------	---

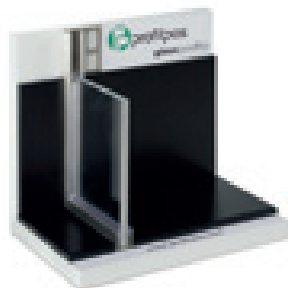

counter display glass profile - brushed stainless steel	00311	€
---	-------	---

counter display glass profile - matt black colour-coated stainless steel	00315	€
--	-------	---



PDS bunch

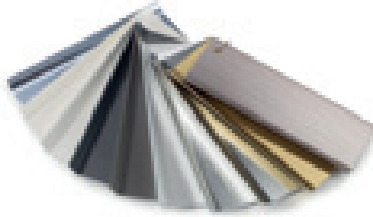

metal line bunch



bunch 8605/8608



pvc skirting board bunch



bunch ZQP



bunch RPA



profiles for balconies bunch



bunch RE



bunch REC



bunch RECO



DIY bunch



sandblast stainless steel bunch



chromium-plated brass bunch



antibacterial profiles bunch

PDS bunch	00020	€
metal line bunch	00119	€
PVC skirting board bunch	00085	€
profiles for balconies bunch	00117	€
ZQP bunch	00027	€
RPA bunch	00050	€
RE bunch	00011	€
REC bunch	00049	€
RECO bunch	00133	€
DIY bunch	00128	€
chromium-plated brass bunch	00130	€
sandblast stainless steel profiles bunch	00132	€
bunch pvc stair nosing	00084	€
bunch antibacterial profiles	00147	€
bunch PDS xl	00140	€
bunch black & white	00033	€
bunch ZV Trend Color	00023	€
bunch IPV Trend Color Stone	00037	€
bunch Prestowood	00039	€
bunch PVC LINE 8181	00018	€
mix bunch (GHF)	00146	€



ES/7 polished white + 11 dividers	11594	€
ES/7 black + 11 dividers	11596	€
Dimensions: width cm 96 - depth cm 50 - height cm 270		
Rack display stand for profiles and skirting boards up to 270 cm long.		
11 width-adjustable dividers.		
ACCESSORIES:		
A) DIVIDER - polished white	11597	€
DIVIDER - black	11598	€
B) LATERAL GRILL - polished white	11519	€
LATERAL GRILL - black	11521	€
For attaching trays and/or hooks for accessories.		
C) Set of 4 TRAYS for lateral grill - polished white	11528	€
Set of 4 TRAYS for lateral grill - black	11531	€
D) Set of 10 HOOKS for lateral grill - polished white	11534	€
Set of 10 HOOKS for lateral grill - black	11535	€
DISPLAY STAND BOARDS:		
board about profiles for ceramic tiles	11522	€
board about profiles for wood, laminate, LVT	11532	€

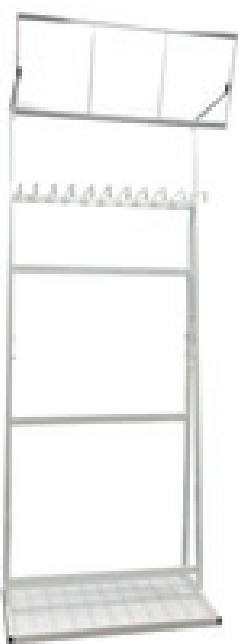

ES/7 polished white + 11 dividers



polished white divider



polished white lateral grill for attaching trays and/or hooks for accessories



polished white tray for lateral grill



polished white hooks for lateral grill

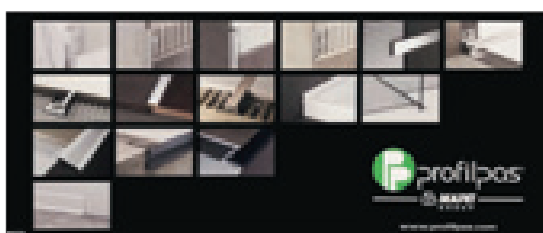

board about profiles for ceramic tiles

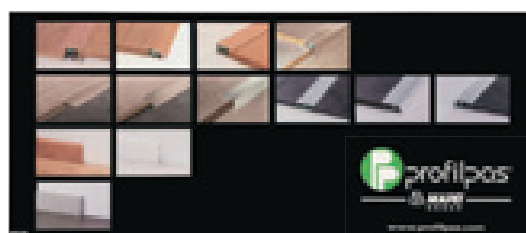

board about profiles for wood, laminate, LVT



ES/6

11506 €

dimensions: width cm 96 - depth cm 28 - height cm 94

MATERIALS AND CHARACTERISTICS

The following information summarize the main characteristics of the materials. Further information are available upon request of the product specifications.

NATURAL BRASS

Alloy CW624N UNI EN 12167 The profiles are produced by extrusion. They have a good resistance to chemical agents and mechanical stresses. On the visible parts the brass naturally oxidizes that creates a superficial glaze. The brass, when exposed to corrosive agents or high humidity, is subject to phenomena of high oxidation and can present superficial spots. Where necessary, it can be restored to its original state by using abrasives or specific polishing products.

POLISHED BRASS

Alloy CW624N UNI EN 12167 The profiles are produced by extrusion and then mechanically polished. The visible surface must be protected from scratches and frictions. The resistance to chemical agents and mechanical stresses is good. On the visible parts the brass naturally oxidizes that creates a superficial glaze. The brass, when exposed to corrosive agents or high humidity, is subject to phenomena of high oxidation and can present superficial spots. Where necessary, it can be restored to its original state by using abrasives or specific polishing products.

CHROMIUM - PLATED BRASS

Alloy CW624N UNI EN 12167 The profiles are produced by extrusion and then chromed. They are resistant to ultraviolet rays, weathering and chemical agents. They are not suitable for applications in floors with intense mechanical stresses.

NATURAL ALUMINIUM

Alloy of Al-Mg-Si thermally treated in conditions T6 (6060 T6) The profiles are produced by extrusion and guarantee a fair resistance to atmospheric and chemical agents. The cement and its derivatives produce, if wet, alkaline substances that, acting on the surface, can corrode the metal (formation of hydroxide of aluminium). For that reason, the visible surface of the profile must be immediately cleaned from cement, glue and other materials used for joints.

ANODISED ALUMINIUM

Alloy of Al-Mg-Si thermally treated in conditions T6 (6060 T6) The profiles are produced by extrusion and then anodised. They have a good resistance to atmospheric and chemical agents. The cement and its derivatives produce, if wet, alkaline substances that, acting on the surface, can corrode the metal (formation of hydroxide of aluminium). For that reason, the visible surface of the profile must be immediately and gently cleaned from cement, glue and other materials used for joints. Wear and pedestrian traffic could damage the surface (in cases of profiles laid on the floor) and remove the original anodised finish.

POLISHED ALUMINIUM

Alloy of Al-Mg-Si thermally treated in conditions T6 (6463 T6) The profiles are produced by extrusion and then mechanically treated and processed. They guarantee a fair resistance to atmospheric and chemical agents. The cement and its derivatives produce, if wet, alkaline substances that, acting on the surface, can corrode the metal (formation of hydroxide of aluminium). For that reason, the visible surface of the profile must be immediately and gently cleaned from cement, glue and other materials used for joints. Polished aluminium profiles are not suitable for floor applications.

COLOUR - COATED ALUMINIUM

Alloy of Al-Mg-Si thermally treated in conditions T6 (6060 T6) The profiles are made by extrusion and then coated with a thickness of $\geq 80 \mu\text{m}$. They have

a fair resistance to atmospheric and chemical agents while they do not have a good resistance to mechanical stresses that would damage the surface enamel; therefore they are not recommended for floor applications. For that reason, the visible surface of the profile must be immediately and gently cleaned from cement, glue and other materials used for joints.

ALCROM® PLUS FOILED ALUMINIUM

Alloy of Al-Mg-Si thermally treated in conditions T6 (6060 T6) The profiles are produced by extrusion in natural alloy. The wood decoration is obtained by foiling the aluminium profiles with a special film Alcrom® Plus, resistant to wear, perfectly reproducing grains and colours of wood.

STAINLESS STEEL - AISI 430 - DIN 1.4016

This kind of stainless steel has a moderate resistance to corrosive agents. We recommend its use exclusively for indoor use.

STAINLESS STEEL - AISI 304 - DIN 1.4301 V2A

It is extremely resistant to most chemical and atmospheric agents, lime, mortar, tile glue and common cleaning products. It is recommended for outdoor use, food processing industry, hospitals, etc.

STAINLESS STEEL - AISI 316 – DIN 1.4404 V4A

It is extremely resistant to most chemical and atmospheric agents, lime, mortar, tile glue and common cleaning products. Moreover it has a good resistance to chlorine and salt. Particularly indicated in extreme conditions of use.

COLOUR-COATED STAINLESS STEEL - AISI 304 - DIN 1.4301

The profiles are made of brushed stainless steel and then coated with a thickness of $\geq 80 \mu\text{m}$. They present a relatively good resistance to chemical and atmospheric agents but not to mechanical stress which damages the surface coating. Concrete, adhesive, grouting materials and detergents must be immediately removed from the visible surface of the profile.

LAYING - WARNINGS:

even stainless steel can be damaged if not treated with proper precautions during the laying stages. In particular, pay attention to: keeping the profiles protected inside their individual packaging up until the installation. (this precaution allows to avoid the contamination with other ferrous materials during the transport). Avoiding the direct contact with cleaning products for cotto tiles and marble, decalcifying agents and cleansers containing chlorine and its compounds. Pay attention to the gases of hydrochloric acid which may develop during the cleansing of special floors. After the laying, proceed immediately with an accurate cleaning of the surface with plenty of water and the consequent drying.

MAINTENANCE:

the frequent cleaning is essential to preserve the beauty of stainless steel profiles surfaces. Pay close attention to the treatment of the profiles' surface during the installation. Immediately after installation, clean by rinsing the surfaces accurately. Avoid the use of abrasive products that may scratch the profile. Do not use cleansers containing chlorine and its compounds, such as bleach, muriatic acid, decalcifying agents. Do not use abrasive sponges or wire wools that may scratch the surface or leave rust stains.

Rigid PVC

Vinyl compound of rigid PVC unleaded, anti shock, non-flammable. Mixture eco-friendly with Ca-Zn salts.

Plasticized PVC

Vinyl compound of plasticized PVC unleaded, non-flammable. Mixture eco-friendly with Ca-Zn salts.

Foam PVC

Vinyl compound of plasticized PVC unleaded, non-flammable. Mixture eco-friendly with Ca-Zn salts.

Co-extruded PVC - Foam/Rigid

Vinyl compound of plasticized PVC unleaded, non-flammable. Mixture eco-friendly with Ca-Zn salts.

Vinyl compound of rigid PVC unleaded, anti shock, non-flammable. Mixture eco-friendly with Ca-Zn salts.

Co-extruded PVC - Rigid/Rigid

Vinyl compound of rigid PVC unleaded, anti-shock non-flammable. Mixture eco-friendly with Ca-Zn salts.

Co-extruded PVC - Plasticized/Plasticized

Vinyl compound of plasticized PVC unleaded, non-flammable. Mixture eco-friendly with Ca-Zn salts.

Co-extruded PVC - Rigid/Plasticized

Vinyl compound of rigid PVC unleaded, anti-shock, non-flammable. Mixture eco-friendly with Ca-Zn salts. Vinyl compound of plasticized PVC unleaded, non-flammable. Mixture eco-friendly with Ca-Zn salts.

Co-extruded PVC - Rigid/Plasticized anti-mould

Vinyl compound of rigid PVC unleaded, anti-shock, non-flammable. Mixture eco-friendly with Ca-Zn salts. Vinyl compound of plasticized PVC unleaded, non-flammable, addicted with biocide. Mixture eco-friendly with Ca-Zn salts.

Co-extruded PVC - Foam/Plasticized

Vinyl compound of foam PVC unleaded, non-flammable. Mixture eco-friendly with Ca-Zn salts. Vinyl compound of plasticized PVC unleaded, non-flammable. Mixture eco-friendly with Ca-Zn salts.

ADVICES FOR CLEANING AND MAINTENANCE

MATERIAL	FINISHING	CLEANING AFTER LAYING	MAINTENANCE
aluminium	anodised	Use of acid based cleaners and not alkaline	exclusive use of neutral cleaning products
aluminium	bril. polished	Use of acid based cleaners and not alkaline	exclusive use of neutral cleaning products
aluminium	bright polished copper	Use of acid based cleaners and not alkaline	exclusive use of neutral cleaning products
aluminium	bright polished titanium	Use of acid based cleaners and not alkaline	exclusive use of neutral cleaning products
aluminium	bright polished gold	Use of acid based cleaners and not alkaline	Exclusive use of neutral cleaning products
aluminium	color-coated	Use of acid based cleaners	use neutral or alkaline detergents
aluminium	bright brushed	Use of acid based cleaners and not alkaline	exclusive use of neutral cleaning products
aluminium	riv. Alcrom Plus	Use of acid based cleaners	Exclusive use of neutral cleaning products
stainless steel	polished	Use of acid based cleaners without chlorine	use neutral or alkaline detergents
stainless steel	Inox AISI 316	Use of acid based cleaners	exclusive use of neutral cleaning products
stainless steel	sandblast	Use of acid based cleaners only neutral	use neutral or alkaline detergents
stainless steel	brushed	Use of acid based cleaners without chlorine	use neutral or alkaline detergents
brass	natural	Use of acid based cleaners only neutral	exclusive use of neutral cleaning products
brass	polished	Use of acid based cleaners only neutral	exclusive use of neutral cleaning products
brass	chromium - plated	Use of acid based cleaners	use neutral or alkaline detergents
PVC		Use of acid based cleaners and not alkaline	exclusive use of neutral cleaning products

PROFILES CHARACTERISTICS AND PACKAGING

SELF-ADHESIVE PROFILES

Self-adhesive profiles are made of non-toxic, non-flammable and solvent free hot-melt glues. Although these products are non-flammable, it is recommended not to expose them to naked flames. Product preservation is guaranteed when stored in "normal" climatic conditions.

Glue deteriorates at temperatures over +90°C and crystallizes at temperatures below -15°C. During the application, the temperature of self-adhesive profiles and the ambient temperature where profiles have to be laid should not be below +10°C.

Important: self-adhesive profiles cannot be laid on friable supports, as junction between two carpet floors or between PVC floors and wall coverings.

DRILLED PROFILES

Screw-mounted profiles are drilled according to the model and the material at issue, so that to lodge 3 mm or 3,5 mm screws, either flat-head or round-head ones.

PACKAGING

The  means blister packaging.

"Individually packed" means that the packaging is made for the single profile with a protective heat shrink film.

MEASURES - TOLERANCES - REFERENCES NORMS - CERTIFICATION ON PRODUCT

Please note that the information and the drawings in the present catalogue are not binding.

The data about measures, such as length, thickness and width refer to nominal measures. The foreseen tolerances, the related norms and reference certifications are indicated in the specifications of products, available on request.

DIRECTIONS

The resistance to chemical products depends on their degree of chemical aggressiveness and therefore it is necessary to make sure in advance of the effects that products used for profile laying, cleaning and maintenance can produce. In particular lime, mortar or tile glue cause strains on the visible surface of profiles. Therefore it is necessary to clean these parts immediately after the laying of the profiles. Please note that in the present catalogue, due to the printing, the colour shades can be slightly different from the real ones.

GENERAL CONDITIONS OF SALE

These General Conditions shall govern all sales contracts executed between Profilpas S.p.A. and the Buyer and shall prevail on all the Buyer's general or individual purchasing conditions. Any derogation to these General Conditions shall be binding on Profilpas only if accepted in writing by the latter.

1. Prices

The prices shown in Profilpas' price list are in Euro per meter but products will be invoiced in Euro per piece with the discounts granted in accordance with the ordered quantities or upon agreement with Profilpas. Prices are exclusive of additional taxes or customs duties. Profilpas expressly reserves the right to modify the prices without notice, in accordance with any fluctuation in the costs of raw materials.

2. Minimum orders

The required minimum order value is fixed at the amount of Euro 500,00.

3. Orders

Purchase orders must be sent in writing. Orders shall be deemed accepted and binding on Profilpas only after receipt by the Buyer of Profilpas' written order confirmation. Only the discounts and the prices indicated in the order confirmation shall be binding for Profilpas. Should the order confirmation contain amendments with respect to the Order, such amendments shall be deemed tacitly accepted by the Buyer after 5 (five) days from receipt of the order confirmation unless the Buyer notifies its disagreement in writing within the above-mentioned term.

4. Delivery terms

Deliveries shall be made EX WORKS (Incoterms 2010) Profilpas warehouse in Cadoneghe (Padova) - Italy. The products shall always be transported at the Buyer's risk according to the Incoterms, and any reimbursements for damages shall be claimed by the Buyer to the carrier in accordance with the relevant agreements and clauses contained in the stipulated insurance policies. Delivery dates are estimated and not guaranteed. Profilpas shall not be responsible for any delay nor for the consequences thereof. In case of delay in delivery, the Buyer shall not have the right to terminate the sales agreement and/or obtain compensation of any direct, indirect or consequential damage suffered, unless in case of intent or gross negligence.

5. Packaging

Prices include Profilpas standard packaging. Sea shipment packaging or any other special packaging requested by the Buyer will be charged at cost. Profilpas' catalogue indicates which products have partial packaging and the surcharge applied in such case.

6. Terms of payment

All payments must be made in accordance with the agreed terms of payment; the relevant sums must be transferred to the bank indicated by Profilpas. In case of delay of payment, whether total or partial, the Buyer shall be bound to pay interest on all outstanding amounts calculated according to art. 5 of Italian Legislative Decree no. 231/2002 or subsequent modifications. Delay or non-payment of any sums due by the Buyer to Profilpas, even if concerning different contractual relationships, shall entitle Profilpas to suspend the preparation and delivery of the products which are the object of the order and of any other order in progress.

7. Claims

Claims must be notified in writing to Profilpas within 10 days from the delivery date. Claims for damaged, stolen or missing products shall be lodged with the carrier upon receipt of the products. If no written complaint is lodged with the carrier, Profilpas will not accept any return or replacement of the delivered products. Return of products will only be accepted upon Profilpas' prior written consent and always at the Buyer's expense.

8. Retention of title (article 1523 of the Italian Civil Code)

The products shall remain the property of Profilpas until full payment. Non-compliance, or partial compliance, of the agreed payment terms allow Profilpas, without prejudice to any other claim it may have, to recover the products supplied. The Buyer is liable for any damage to the products due to poor storage or negligence and shall be responsible as a depositary. Profilpas does not assume responsibility for damage to the products consequential or subsequent to the installation of the same.

9. Warranty and defects

Profilpas guarantees that the products are free from defects in material and workmanship for a period of 12 months from the date of delivery to the Buyer. Should Profilpas acknowledge the existence of the claimed defects, and provided that it has been promptly notified in accordance with the above mentioned paragraph "Claims", Profilpas' warranty shall be limited, at its discretion, to the replacement of the defective products, free of charge EXW Profilpas' premises (Incoterms 2010), within the normal time required therefor, or to the issue of a credit note for the amount of the defective products, ANY OTHER LEGAL OR CONVENTIONAL WARRANTY OR CLAIMS FOR ANY FURTHER DIRECT, INDIRECT OR CONSEQUENTIAL DAMAGES SUSTAINED BY THE BUYER OR THIRD PARTIES, UNLESS IN CASE OF INTENT OR GROSS NEGLIGENCE OR IN CASES OF MANDATORY LEGAL REQUIREMENTS, BEING EXPRESSLY EXCLUDED.

The Buyer expressly waives its right of regress according to article 134 of the Italian Consumers' Code.

No products will be returned by the Buyer without prior written permission by Profilpas. Profilpas does not guarantee the compliance of the products to any particular specifications or technical characteristics or their suitability for any use and/or special uses if not to the extent that such characteristics have been expressly agreed in the sales contract. Profilpas is not liable for damages that the Buyer, or third parties, generate by using the products if the damage does not depend on the quality or intrinsic characteristics of the product, but by the choice of purchase and usage of the same by the Buyer.

10. Industrial and intellectual property

Profilpas Spa's trademarks, distinguishing signs, designs, photographs of products and/or production and commercial technology shall be considered strictly confidential and shall not be used without prior written authorization from the same.

11. Express delivery

Upon the Buyer's request, Profilpas can offer a service of express delivery. The surcharge for this express service will be communicated with the order confirmation.

12. Privacy

The parties undertake to comply with the laws - including EU Regulation 2016/679 "General data protection regulation" or "GDPR" - on the protection and processing of personal data that may apply to the relationships between the Parties pursuant to this agreement and assume the qualification as "data controller" in relation to the personal data acquired in the performance of this agreement. The parties declare that they have security devices and systems which are appropriate for the protection of the personal data in their possession, including the personal data acquired hereunder, against risks of destruction or loss, also accidental, unauthorized access, processing not allowed or not consistent with the purpose of the data collection.

13. Final clauses

Profilpas sales are governed by the laws of Italy. In case of dispute, the courts of Padua - Italy shall be the exclusive competent venue.

Handwriting practice lines consisting of horizontal lines spaced evenly down the page.

020/	104
023/	107
024/	107
026/	105
030/	107
040/	107
050/	131
060/	131
076/	44
080/	131
0100/	131
6/	117
10/	117
19/	106
21/	103
22/A	106 - 178 - 179
25/	106
30/	103
35/	103
41/	103
45/	112
46/	117
50/A	178 - 179
54/	117
55/	55/
57/	114
58/	154 - 180
61/	114
63/A	178 - 179
70/	155
71/	155
72/	158
73/	154 - 180
74/	154 - 180
75/F	153 - 186
76/	156
78/	159
79/	158
80/	157
87/	154
87/6	202 - 233
88/6	202 - 233
88/16SF	202
88/16L/A	202 - 233
88/6E	202 - 233
89/	198 - 199
89/ EI	198 - 199
89/ TM	198
89/ TMEI	198
89/6L	199 - 234
89/6EI	199 - 234

89/613	200
89/613EI	200
89H/	198
89H/ EI	198
90/ A	194
90/ BSF	194
90/ E	195
90/ G	195
90/ I	195
90/ MI	195
90/ ME	195
90/ MG	195
90/ MP	195
90/ P	195
90/ SF	194
90/ SSF	194
90/ TMSF	194
90H/6ME	195
90H/6MG	195
90H/6MI	195
90H/6MP	195
90H/6SF	194
92/7	197
93/	197
94/7SF	205
95/ E	205
95/ G	205
95/ I	205
95/ P	205
95/ SF	205
97/4E	207
97/4G	207
97/4I	207
97/4P	207
97/4SF	207
97/7E	208
97/7G	208
97/7I	208
97/7P	208
97/7SF	208
97/8CB	209
97/8E	209
97/8G	209
97/8I	209
97/8P	209
97/8SF	209
98/7E	206
98/7G	206
98/7I	206
98/7P	206
98/7SF	206

99/M	102
99/R/	102
99/T/	100 - 185
99/TR/26	100 - 185
100/	204
101/74	204
105/7	201
105/7E	201
105/7G	201
105/7I	201
105/7P	201
105/CB	201
110/	156
111/ /F	153 - 186
124/	156
125/	158
126/	157
126/L/F	231
126/LP/DX	231
126/LP/SX	231
130/	155
148/B	222
148/C	222
150	160
150/	164
151	160
151/11	164
152	160
154	161
155	161
155/16	164
156	161
161/11	165
163/	164
168/16	165
169	223
169/	165
170	223
170/	165
171	223
171/11	165
172	222
173	222
174/	165
175/11	165
177/16	165
178/16	165
210/	42
210H/A	42
220/	42
277/	42

300/	116	790/ MGS	196	8603/I	220
311/	115	790/ MI	196	8603/P dx/sx	220
312/	115	790/ MIS	196	8605	212
370/	154	790/ MP	196	8606	212
373/	154	790/ MPS	196	8607	221
380/8	99	790/ SF	196	8607/E	221
399/10	102	799/	99	8607/G	221
399/M	102	799/T/	101	8607/I	221
399/R/	102	799/TS/	101	8607/P dx/sx	221
399/T/	101 - 185	799/U/	99	8608	213
399/TC/	101 - 185	4020/	104	8608/C	197 - 213 - 215
399/U	99	4026/	105	8610	45
419/	106	4030/	107	8611	45
422/AD	106 - 178 - 179	4050/	131	8612/10	216
425/	106	4060/	131	8613	215
430/	103	4080/	131	8614	216
441/	103	4150/11/S	164	8615	214
450/AD	178 - 179	4170/ /S	165	8616	214
455/	114	4300/	116	30052	250
457/	114	4311/	115	AF/1	51 - 203
461/	114	4312/	115	AI/	28 - 94 - 187
470/	155	4399/R/10	102	AI/ /E	28
473/	154	4399/T	101	AIF/	96
474/	154	4701/	116	AIL/	28
476/	156	4711/	115	AIP/	28
487/	154	4712/	115	AIS/	28 - 94
499/T	100	4720/	104	AIS/ /E	28
700/	116	4722/	104	AIX/	28 - 94
701/	116	4726/	105	AL/120/24	236
711/	115	4729/	105	AL/150/24	236
712/	115	4730/	107	AL/60/24	236
720/	104	4750/	131	AL/90/24	236
722/	104	4760/	131	AX/2/	41
723/	107	4780/	131	BH/20	91
724/	107	4799/T	101	BH/20/A	91
726/	105	4799/TS	101	BI/40	63
729/	105	7100/	131	BI/40/A	63
730/	107	8181	217	BL/	62
732/SF/	116	8580	218	BLA/	62
740/	107	8582	218	BLAH/	62
750/	131	8596	218	BP/20	91
760/	131	8598	218	BP/20/A	91
774/	43	8600	217	BP/22	90
775/	43	8602	219	BP/25	90
776/	43	8602/C	207 - 219 - 220 - 221	BPK/20	91
777/	43	8602/E	219	BPK/25	90
779/SF	43	8602/I	219	BPT/20	91
780/	131	8602/P dx/sx	219	BPT/22	90
790/ ME	196	8603	220	BPT/25	90
790/ MES	196	8603/E	220	C/10/SF	172
790/ MG	196	8603/G	220	C/13/SF	172

C/22/SF	172	CPHA/	144	FIX/J/30	183
C/4	176	CPHV/	144	FIX/J/44	182
C/7/SF	170 - 171	CPHA/ /E	144	FIX/L/32	183
CE/10/100	237	CPHV/ /E	144	FIX/L/55	182
CE/10/20	237	CPLB	145	FIX/T/19	183
CE/5/20	237	CPLB/2	145	FIX/T/33	182
CE/RGB/20	237	CPLV/	145	FLM/C	246
CLA/	227	CPLV/ /E	145	FLM/S	246
CLA/8A	227	CPLV/ /G	145	FMA/	40
CLA/8P	227	CPNV/45/	142	FMAC/	40
CN28	248	CPNV/45/ /E	142	FMAE/	40
CPBV/	143	CPNV/45/ /G	142	FMAI/	40
CPBV/ /E	143	CPNVF/45/	142	FMB/	40
CPBV/ /G	143	CPQV/50/	139	FMBC/	40
CPCI/55/	134	CPQV/50/ /E	139	FMBE/	40
CPCI/55/ /E	135	CPQV/50/G	139	FMBI/	40
CPCI/55/ /G	135	CPQV/70/	139	FMI/	40
CPCI/75/	134	CPQV/70/ /E	139	FMIC/	40
CPCI/75/ /E	135	CPQV/70/G	139	FMICS/	40
CPCI/75/ /G	135	D/4461/K	249	FMIE/	40
CPCI/95/	134	D/4471/K	249	FMIES/	40
CPCI/95/ /E	135	DC1	248	FMII/	40
CPCI/95/ /G	135	DC10	248	FMIIS/	40
CPCV/30/	136	DC2	248	FMIS/	40
CPCV/30/ /E	136	DC3	248	G/2/SF	174
CPCV/30/ /G	136	DC4	248	G/4/SF	175
CPCV/55/	134	DC5	248	G/40/	130
CPCV/55/ /E	135	DC7	248	G/460/	130
CPCV/55/ /G	135	DCE4	248	G/60/	130
CPCV/75/	134	DI/	97	G/705/F	186
CPCV/75/ /E	135	DIMM/02	236	G/80/	130
CPCV/75/ /G	135	DJA/	97	G/9/F	230
CPCV/95/	134	DJA/ /EI	97	G/9P/DX	230
CPCV/95/ /E	135	DJAF/	97	G/9P/SX	230
CPCV/95/ /G	135	DJG/	97	GA/	56 - 188
CPCVD/30/	137	DJG/ /EI	97	GAN/	57
CPCVD/30/ /E	137	DJK/	97	GBL/ /C	62
CPCVD/30/ /G	137	DJK/ /EI	97	GBL/ /E	62
CPCVF/55/	134	DJKC/10	52	GBL/ /I	62
CPEI/45/	140	DJKG/10	53	GBL/ /T	62
CPEI/45/ /E	141	DJKG/10	53	GF/	153
CPEI/45/ /G	141	DJN/	97	GG/2	82
CPEV/45/	140	DJN/ /EI	97	GG/3	82
CPEV/45/ /E	141	DJNF/	97	GG/4	82
CPEV/45/ /G	141	DT1	248	GIC/	60
CPEV/72/	140	DT10	248	GIN/	58
CPEV/72/ /E	141	DT2	248	GIN/ /SA	58
CPEV/72/ /G	141	DT3	248	GINS/	58
CPGV/55/	138	DT4	248	GINS/ /SA	58
CPGV/55/ /E	138	DT5	248	GINX/	58
CPGV/55/ /G	138	DT7	248	GINX/ /SA	58

GJA/	129
GJF/	129
GJS/10	129
GM12/L	123
GM/10	123
GM/72	158
GM/78	159
GM/I	122
GM/R	158
GMP/I	122
GMR/44	157 - 231
GP/	59
GPS/6	82
GPS1/ /19	82
GPS14/12	83
GPS2/	83
GPS3/ /10	84 - 85
GPS3/ /11	84 - 85
GPS3/ /12	84 - 85
GPS4/ /10	86 - 87
GPS4/ /11	86 - 87
GPS4/ /12	86 - 87
GPS5/10/	88
GPS5/11/	88
GPS5/12/	88
GPU/	59
GR/80/	130
GTA/E	56
GTA/I	56
GTIN/C	58
GTIN/E	58 - 60
GTIN/G	58 - 60
GTIN/I	58 - 60
GTIN/T	58 - 60
GTINS/C	58
GTINS/E	58
GTINS/G	58
GTINS/I	58
GTINS/T	58
GTINX/C	58
GTINX/E	58
GTINX/G	58
GTINX/I	58
GTINX/T	58
GTL/C	63
GTL/E	63
GTL/I	63
GTL/T	63
GTP/C	57 - 59
GTP/E	57 - 59
GTP/I	57 - 59
GTP/T	57 - 59
GTV/E	56
GTV/I	56
GU/30/	89
GU/40/	89
GV/	56
GVNH/	57
GWA/	129
H3502	162
H/5/F	185
IL/	46
ILN/	46
ILNS/	46
ILNX/	46
IP/40	44
IPA/	31 - 149
IPB/	31 - 149
IP/	31 - 149
IPV/	31
IR/C01	237
IR/C01NT	237
IR/C02	237
IR/C03	237
IR/W3	237
JGA/	188
K10	249
KLM/10	246 - 247
KLM/15	246 - 247
KLM/20	246 - 247
KLM/30	246 - 247
KLM/50	246 - 247
KLM/C	247
KLM/T10	246 - 247
KLM/T15	246 - 247
KLM/T20	246 - 247
KLM/T30	246 - 247
KLM/X10	246 - 247
KLM/X15	246 - 247
KLM/X20	246 - 247
KLM/X30	246 - 247
L5/NW/33	236
L5/NW/65NT	236
L5/NW/67	236
L5/NW/67NT	236
L5/RGB/67	236
L5/WW/33	236
L5/WW/67	236
LA/I/	50
LA/IS/	50
LB/A	50
LB/B/	50
LDA/	50
LDAD	51
LDAG/	50
LDB/	50
LDRS/	50
LDS/	50
LDTM/	50
LDV/	50
LLA/20	226
LLA/20P	226
LLA/20/10	226
LLA/30	226
LLA/30P	226
LLB/30	226
LLB/30P	226
LQL/2	228
MIN/	41 - 113
MS 45 - MS 55	91 - 204 - 222 - 249
NAN/	122
NE/	120
NF/	121
NIL/	123
NIN/	123
NJ/	120
NL/	121
NPAN/	122
NTA/	124
NTI/	124
NTO/	124
NZA/	125 - 184
NZS/	125
NZS/A/40	125
NZS/B/	110
NZS/L/	125
NZS/S1	110
NZS/S2	110
PA/	111
PAS/	127
POLISHING PASTE	249
PBA/	112
PBA/5/A	184
PBAS/5/F	185
PBE/	126
PBH/	127
PFFE/	128
PHDE/	128
PI/	61
PIA/	61 - 188
PIN/	60
PLA/	113
PN/	111

PNI/	111	RINS/	35	STA/	124
PNIS/	111	RINX/	35	STI/	124
PP/	68	RIP/	34	TA/	33
PP360/	68	RIS/	34	TAS/	33
PP50/	68	RIX/	34	TATM/	33
PROFLEX MACHINE	250	RKN/	36	TB/	33
PT/4	177	RLN/	36	TE/	38
PT/4/SA	177	RPA/	37	TEI/	38
PT/6	177	RR/5	249	TEL/04	236
PT/6/SA	177	RTM/	32	TEL/RGB/04	236
PTC	245	RV/	32	TGU/	89
PTC/3000	245	RVH/	32	THIN/	73
PTC1	245	S/15/SF	172	TIA/	33
PTC1/3000	245	S/4	176	TIAS/	33
PTC1A	245	S/9/SF	170 - 171	TIB/	33
PTC1A/3000	245	S/95	197 - 205 - 206 - 208	TIE/	34
PTC2	245	S/97	209	TIEL/	36
PTC2/3000	245	SA/	152	TIEN/	35
PTC3	245	SA/G	152	TIENS/	35
PTC3/3000	245	SAFETY-STEP	162 - 163	TIENX/	35
PTC4/1	245	SAR/10/12	150	TIEP/	34
PTC4/2	245	SAR/8/15	150	TIES/	34
PTC4/3	245	SB/	152	TIEX/	34
PTC4/5	245	SB/G	152	TII/	34
PTLN	245	SGA/	148	TIIL/	36
PTS	245	SGA/11L	230	TIIN/	35
PTWN	245	SGA/11P	230	TIINS/	35
PTWN/1400	245	SGI/	148	TIINX/	35
PV/	30	SGK/	148	TIIP/	34
QDC/1010	79	SGN/	148	TIIS/	34
QDCC/1010	79	SIR/10/12	150	TIIX/	34
QDI/1010	79	SIR/8/15	150	TIME/	35
QDL/1010	79	SIRS/10/12	150	TIMI/	35
RA/	32 - 187	SIRS/8/15	150	TIV/	33
RAS/	32	SIS/	151	TLA/10/C1	227
RB/	32	SIS/10/SF	151	TLA/10P/C1	227
RC/ /F	181	SIX/	151	TLB/10/C1	227
RC/411/CV	181	SKL/2	203 - 232	TLB/10P/C1	227
RC/415/CV	181	SLIM/	75	TOP/ /E	47
RC/47/CV	181	SLIM-I/	75	TOP/ /ETM	47
RC/49/CV	181	SM/	148	TOP/ /I	47
RC/5/F	185	SMA/	148	TOP/ /ITM	47
RCF/	181	SMART/	77	TOP/A/	47
RE/	38	SMART3/	77	TOP/TM/	47
REC/ /100	39	SMART-I/	77	TPAE/	37
RECO/ /80	39	SN/	149	TPAI/	37
RI/	34 - 187	SNG/	149	TPC/410/CV	173
RIC/01	236	SP/	152	TPC/413/CV	173
RIC/RGB/M	237	SS/4	249	TPC/47/CV	173
RIC/RGB/S	237	SS/5	249	TPS/410/CV	173
RIN/	35	ST/7	124	TPS/413/CV	173

TPS/47/CV	173
TPU/	171 - 172 - 174 - 175
TPZ/410/CV	173
TPZ/413/CV	173
TPZ/47/CV	173
TU/6	171 - 172 - 174 - 175
TV/	33
UA/	98
UA/ /EI	98
UG/	98
UG/ /EI	98
UI/	98
UI/ /EI	98
UIS/	98
UIS/ /EI	98
UK/	98
UK/ /EI	98
UKC/10	52
UKG/10	53
UKGC/10	53
UN/	98
UN/ /EI	98
VITI	249
XLC/	77
XLC3/	77
XLCC/	77
XLL/	77
XPC/	69
XPD/	71
XPF/	70
XPI/	71
XSC/	75
XSCC/	75
XSL/	75
XTC/	73
XTCC/	73
XTL/	73
XTT/	73
Z/1/SF	170 - 171
Z/4	176
Z3/30/SF	172
ZA/	26 - 94
ZB/	26
ZBG/	95
ZBGF/	96
ZBS/	26
ZG/	94
ZGF/	96 - 186
ZK/	29 - 94
ZN/	94
ZNF/	96

ZQAGN/	18
ZQAGN/ /EI	19
ZQAL/10	229
ZQAL/10B	229
ZQAL/10P	229
ZQAN/	18 - 187
ZQAN/ /EI	19
ZQAND/	22
ZQAND/ /EI	22
ZQBN/	18
ZQBN/ /EI	19
ZQBRSN/	18
ZQBRSN/ /EI	19
ZQBSN/	18
ZQBSN/ /EI	19
ZQIM/ /EI	23
ZQIMP/ /EI	23
ZQIMS/ /EI	23
ZQIN/	23
ZQIN/ /EI	23
ZQINP/	23
ZQINP/ /EI	23
ZQINS/	23
ZQINS/ /EI	23
ZQINX/	23
ZQINX/ /EI	23
ZQKN/	24 - 187
ZQKN/ /EI	24
ZQLN/	24
ZQLN/ /EI	24
ZQP/	25
ZQP/ /EI	25
ZQTMN/	18
ZQTMN/ /EI	19
ZQVN/	18
ZQVN/ /EI	19
ZQVNH/	18
ZTM/	26
ZV/	26 - 27
ZVH/	26



Profilpas S.p.A.

Sede legale:

Viale E. Jenner, 4
20159 Milano (MI) Italy

Sede operativa:

Via Einstein, 38
35010 Cadoneghe (PD) Italy

Customer Service Italia: +39 049 8878411

Customer Service Export: +39 049 8878412

Assistenza Tecnica: +39 049 8878416

info@profilpas.com

profilpas.com

