

20 24



**Catalogue
Export_01**

**Supports for
raised floors**



INDEX



PP LEVEL DUO MAXI _____ pag 4



PP LEVEL MAXI FIX _____ pag 14



PP LEVEL DUO® _____ pag 18



PP LEVEL FIX _____ pag 28



PP LEVEL MINI _____ pag 32



PP LEVEL SP _____ pag 32

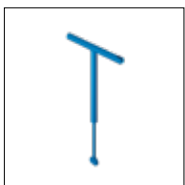

ACCESSORIES FOR INSTALLATION _____ pag 36



POS MATERIAL _____ pag 44

INDEX BY ITEM _____ pag 46

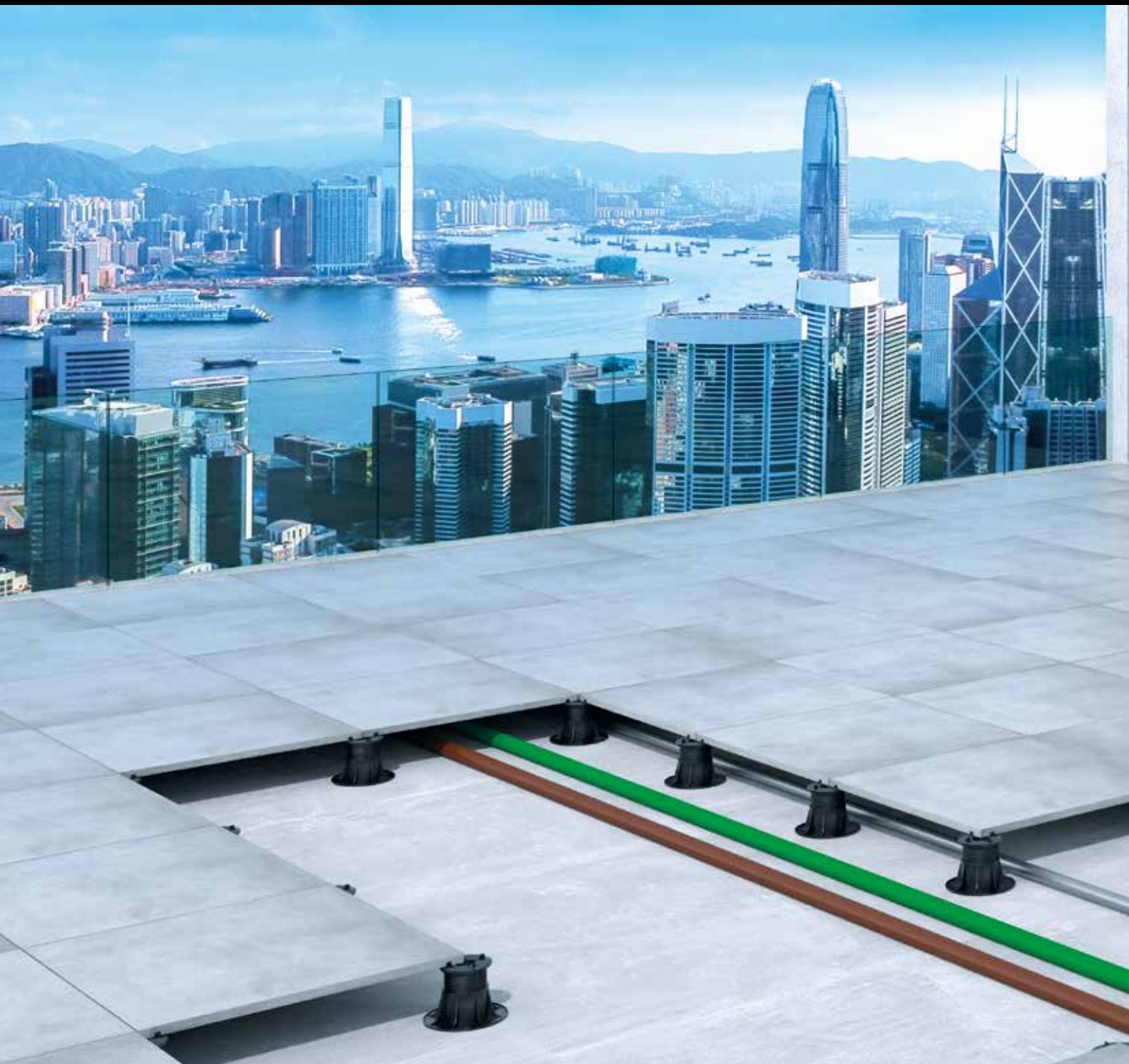

**PP level DUO
MAXI**



supports for raised floors

PP level DUO MAXI

PPlevel**DUO****MAXI**



THE SYSTEM FOR THE INSTALLATION OF RAISED FLOORS, MAXI IN EVERYTHING



PP level DUO MAXI is a range of adjustable supports for outdoor raised floors designed and produced by Profilpas. **MAXI flexibility:** thanks to the practical Fixed Head Ring, you can transform the self-levelling head, able to compensate for surface slopes up to 5%, into fixed head, directly during the installation. **MAXI strength:** the support guarantees excellent resistance to heavy loads and weather elements. **MAXI versatility:** numerous accessories are available for any installation requirement, from extensions to aluminium joists, rubber mats and steel clips. With PP Level DUO MAXI the installation of the raised floor will be easy, fast and perfect.





SELF-LEVELLING OR FIXED HEAD

According to the conformation of the subfloor and the needs that may arise during the installation, with PP Level DUO MAXI you can choose between **self-levelling head**, which allows you to compensate for slopes up to 5%, or **fixed head** directly during the installation. To obtain a fixed head support, simply insert the practical **Fixed Head Ring**, already integrated into the base and ready to use, between the head and the screw.

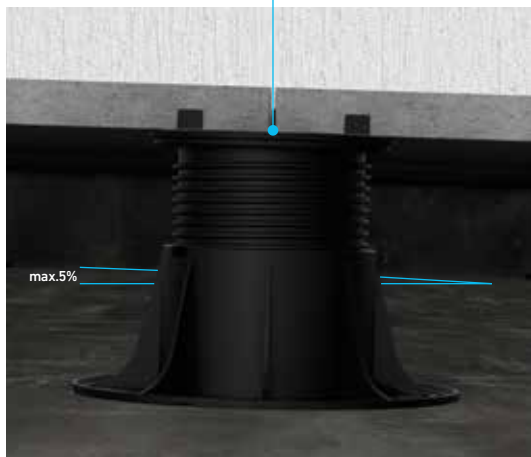

FIXED HEAD SUPPORT

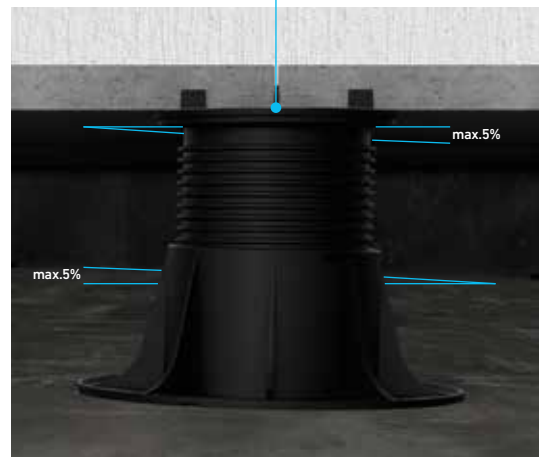

SELF-LEVELLING HEAD SUPPORT

CHARACTERISTICS AND ADVANTAGES

Raised floors are the ideal solution for building renovations and new buildings. Their advantages are many: they are **simple and quick to install** and just as **quick to remove** for any maintenance of cables and pipes or to inspect the waterproofing layer. Moreover, they **absorb expansions** and structural movements, thus preventing cracks and breaks, and **facilitate air recirculation** between the floor and the waterproofing layer.



VERSATILITY OF THE RANGE

The range, composed of **four bases, three heads and one extension**, solves all heights in all types of installation, from ceramic tiles laid directly on supports or on joists to decking-type flooring.



WATER DISPOSAL

A **system of drainage holes** at the head connection and at the support base prevents the stagnation of rainwater, ensuring its effective disposal.



EASY AND MILLIMETRIC ADJUSTMENT

The support height can be adjusted to the millimetre, even when the floor has already been laid, using the provided adjustment **key**, so that to obtain perfectly level floors without wasting time.



SPEED AND EASE OF INSTALLATION

The support is **simple and quick to assemble**. Likewise, the installation of the raised floor is fast and easy, thanks to the height adjustment from above.



MAXIMUM DURABILITY

PP level DUO MAXI supports have a high **mechanical resistance to compression** and are **resistant to the most extreme climatic conditions** (UV, weathering elements, temperatures from -40°C to +75°C).



TOTALLY RECYCLABLE

All elements that make up PP level DUO MAXI are made of **recyclable plastic**.

THE RANGE



S/28/39B
h. 28-39 mm



M/38/57B
h. 38-57 mm



L/56/91B
h. 56-91 mm



XL/87/150B
h. 87-150 mm



P1/80TE
Extension h. 80 mm



PP LEVEL DUO MAXI + P1/80TE EXTENSION

P1/80TE	+1	+2	+3	+4	+5
L/56/91B	136 / 195	-	-	-	-
XL/87/150B	167 / 254	247 / 358	327 / 462	407 / 566	487 / 671
P1/80TE	+6	+7	+8	+9	+10
L/56/91B	-	-	-	-	-
XL/87/150B	567 / 775	647 / 879	727 / 983	807 / 1087	887 / 1192

measures indicate h. min / h. max

SUPPORTS FOR ANY INSTALLATION REQUIREMENT

With PP level DUO MAXI, Profilpas wants to offer an **integrated system of solutions** to compensate for small and large slopes, up to 5%, and obtain perfectly stable and level raised surfaces of any height. A complete range, able to satisfy any installation requirement, which can be used with **different self-supporting coverings**, such as ceramic tiles, single- and multi-format ceramic planks, wooden coverings, decking or other materials.



PPLM/T2
PPLM/T3
PPLM/T4

SELF-LEVELLING HEAD FOR CERAMIC FLOORS

Head to be used for the **installation of ceramic floors**, equipped with easily removable tabs for 2, 3 and 4 mm joints and noise-proof, anti-slip, heat-sealed rubber for a greater acoustic comfort and maximum stability.



PPLM/TA

CRISSCROSS HEAD FOR ALUMINIUM JOISTS

Crisscross head to be used with special aluminium joists, for the **installation of raised floors with single- and multi-format ceramic planks**. With these joists, equipped with a rail for positioning the spacers, it is possible to create a substructure that increases stability and load-bearing capacity. When turned upside down, the joist can also be used for installing **decking floors**.



PPLM/TD

UNIVERSAL L-HEAD FOR JOISTS

Universal L-head for screw fixing of all types of joists for the **installation of decking floors**.



- 1 PP level DUO MAXI with self-levelling head PPLM/T2-3-4 for the installation of ceramic floors.
- 2 PP level DUO MAXI system with crisscross head PPLM/TA and aluminium joists PPL/T1 for the installation of single- and multi-format ceramic planks.
- 3 PP level DUO MAXI system with crisscross head PPLM/TA and aluminium crosswise joists PPL/T1 for greater stability at heights above 40 cm.
- 4 PP level DUO MAXI system with crisscross head PPLM/TA and rotated aluminium joists PPL/T1 for the installation of decking floors.
- 5 PP level DUO MAXI system with L-head PPLM/TD for the installation of decking floors with joists PPL/5030/T.

PP level DUO MAXI



S/28/39/4



M/38/57/4



L/56/91/4



XL/87/150/4



S/28/39B



M/38/57B



L/56/91B



XL/87/150B



P1/10



P1/80TE

PP LEVEL DUO MAXI - BASE + SCREW + HEAD 4 MM

ART.		code	pack	pallet
S/28/39/4	base + screw + head 4 mm adjustable from h. 28 to 39 mm	19270	24 pcs	1152 pcs
M/38/57/4	base + screw + head 4 mm adjustable from h. 38 to 57 mm	19271	24 pcs	960 pcs
L/56/91/4	base + screw + head 4 mm adjustable from h. 56 to 91 mm	19272	24 pcs	672 pcs
XL/87/150/4	base + screw + head 4 mm adjustable from h. 87 to 150 mm	19273	24 pcs	480 pcs

no partial packaging

PP LEVEL DUO MAXI - BASE + SCREW

ART.		code	pack	pallet
S/28/39B	base + screw adjustable from h. 28 to 39 mm	19250	24 pcs	1152 pcs
M/38/57B	base + screw adjustable from h. 38 to 57 mm	19251	24 pcs	1152 pcs
L/56/91B	base + screw adjustable from h. 56 to 91 mm	19252	24 pcs	672 pcs
XL/87/150B	base + screw adjustable from h. 87 to 150 mm	19253	24 pcs	480 pcs

no partial packaging

EXTENSIONS FOR PP LEVEL DUO MAXI

ART.		code	pack	pallet
P1/10	extension h. 10 mm	19369	15 pcs	1800 pcs
P1/80TE	extension h. 80 mm	19254	24 pcs	960 pcs

no partial packaging

L/56/91B+P1/80TE	=	136/195 mm	XL/87/150B+(6xP1/80TE)	=	567/775 mm
XL/87/150B+P1/80TE	=	167/254 mm	XL/87/150B+(7xP1/80TE)	=	647/879 mm
XL/87/150B+(2xP1/80TE)	=	247/358 mm	XL/87/150B+(8xP1/80TE)	=	727/983 mm
XL/87/150B+(3xP1/80TE)	=	327/462 mm	XL/87/150B+(9xP1/80TE)	=	807/1087 mm
XL/87/150B+(4xP1/80TE)	=	407/566 mm	XL/87/150B+(10xP1/80TE)	=	887/1192 mm
XL/87/150B+(5xP1/80TE)	=	487/671 mm			



PPLM/T2
PPLM/T3
PPLM/T4



PPLM/TA



PPL/T1



PPL/D4

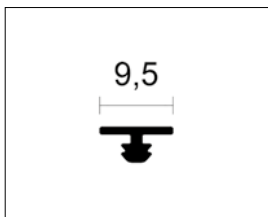

PPL/GM50
PPL/GM200



PPL/GR1



PPLM/TD



PPL/5030/T



PPL/TD/GR



PPL/TD/TT

PP LEVEL DUO MAXI - SELF-LEVELLING HEAD FOR CERAMIC FLOORS

ART.		code	pack	pallet
PPLM/T2	head for 2 mm joints	19255	48 pcs	3840 pcs
PPLM/T3	head for 3 mm joints	19256	48 pcs	3840 pcs
PPLM/T4	head for 4 mm joints	19257	48 pcs	3840 pcs

no partial packaging

PP LEVEL DUO MAXI - JOIST

ART.		code	pack	pallet
PPLM/TA	head for aluminium joist	19259	48 pcs	3840 pcs
PPL/T1	natural aluminium joist section 60,3x24 mm - L 240 cm	19260	8 pcs	
PPL/D4	4-mm spacer for PPL/T1 joist	19398	500 pcs	
PPL/GM50	noise-proof rubber for PPL/T1 joist - 50 meters roll	19263	1 pcs	
PPL/GM200	noise-proof rubber for PPL/T1 joist - 200 meters roll	19264	1 pcs	
PPL/GR1	connection joint for PPL/T1 joist	19265	250 pcs	

no partial packaging

PP LEVEL DUO MAXI - DECKING

ART.		code	pack	pallet
PPLM/TD	head for decking	19258	48 pcs	3840 pcs
PPL/5030/T	natural aluminium joist for decking - section 50x30 mm - length 200 cm	19389	8 pcs	160 pcs
PPL/TD/GR	connection joint for decking joist	19387	12 pcs	
PPL/TD/TT	T connection joint for decking joist	19388	20 pcs	

no partial packaging





**PP level
MAXI FIX**

PP LEVEL MAXI FIX,
ADJUSTABLE FIXED HEAD SUPPORTS



PP level MAXI FIX is a line of **adjustable, fixed-head supports** for self-supporting outdoor raised floors. Available for heights from 25 to 462 mm, PP level MAXI FIX supports can be adjusted in height from above through the adjustment key and have a head with tabs for 4-mm joints. They are ideal for floor coverings on flat surfaces or when the floor covering must be parallel to the surface on which the support lays.





S/28/39B



M/38/57B



L/56/91B



XL/87/150B



P1/10



P1/80TE



PPLM/T4F

PP LEVEL MAXI FIX - BASE + SCREW

ART.		code	pack	pallet
S/28/39B	base + screw adjustable from h. 28 to 39 mm	19250	24 pcs	1152 pcs
M/38/57B	base + screw adjustable from h. 38 to 57 mm	19251	24 pcs	1152 pcs
L/56/91B	base + screw adjustable from h. 56 to 91 mm	19252	24 pcs	672 pcs
XL/87/150B	base + screw adjustable from h. 87 to 150 mm	19253	24 pcs	480 pcs

no partial packaging

with fixed head PPLM/T4F the ranges of the bases + screws are to be considered 3 mm lower, therefore the heights will be S: 25 to 36, M: 35 to 54, L: 53 to 88, XL: 84 to 147.

EXTENSIONS FOR PP LEVEL MAXI FIX

ART.		code	pack	pallet
P1/10	extension h. 10 mm	19369	15 pcs	1800 pcs
P1/80TE	extension h. 80 mm	19254	24 pcs	960 pcs

no partial packaging

L/56/91B+P1/80TE	=	136/195 mm	XL/87/150B+(2xP1/80TE)	=	247/358 mm
XL/87/150B+P1/80TE	=	167/254 mm	XL/87/150B+(3xP1/80TE)	=	327/462 mm

For heights above 462 mm, it is recommended to use the joist system and its head (see page 13).

PP LEVEL MAXI FIX - FIXED HEAD FOR CERAMIC FLOORS

ART.		cod.	Conf.	Pallet
PPLM/T4F	fixed head for 4 mm joints	19261	48 pcs	3840 pcs

no partial packaging





PP level DUO®

supports for raised floors

PP level DUO®

PPlevelDUO®



FIXED OR SELF-LEVELLING HEAD, IN AN INSTANT



With the supports for raised floors PP level DUO® by Profilpas, there is the possibility to **choose between fixed and self-levelling head in an instant**, directly during the installation.

A choice that can be made easily, thanks to the **special converter Perfect Ring**. Indeed, if you insert it between the head and the screw, the support becomes fixed. On the contrary, if there is the need to compensate the slope of a surface up to 6%, it will be sufficient not to insert the ring to obtain a self-levelling system.

In addition to simplifying the activity of installation, PP level DUO® substitutes the double stock of supports with fixed and self-levelling head.





With Perfect Ring,
the support is fixed.

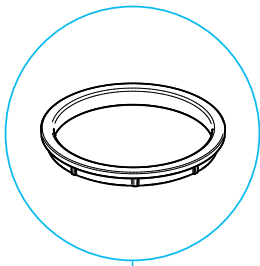

FIXED HEAD SUPPORT

Without Perfect Ring,
the support is self-levelling.

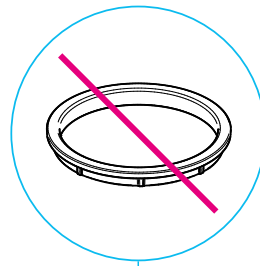

SELF-LEVELLING HEAD SUPPORT

FIVE SUPPORTS, FOR ALL HEIGHTS

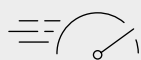

SPEED OF INSTALLATION

Just **5 seconds** to assemble the support.



HEIGHT ADJUSTMENT FROM THE TOP

Height adjustment from the top through the **adjustment key**.



WIDE EXCURSION

Adjustable supports with **wide excursion of available heights**, without the need to add an extension element.



PROTECTION OF WATERPROOFING

The **solid and blunt base** impedes the incision of the underlying membrane subject to loads.



ACOUSTIC INSULATION

Noise-proof rubber integrated with the head.



NO STAGNATION

A **system of draining holes** and canalizations impedes the stagnation of water in every part of the support.



SOLID SUPPORT BASE

Solid support base of 340 cm² for a better distribution of the weight.



PRECISE ADJUSTMENT

Precise adjustment of the sloping to guarantee a **perfect flat surface**.



TABS FOR 2, 3 AND 4 MM JOINTS

Pre-cut 2, 3 and 4 mm tabs for an easy removal.



ECOLOGICAL

All the support is made of **recyclable plastic material**.

Pre-cut tabs for joints
of 2, 3 and 4 mm

Head with integrated
noise-proof rubber

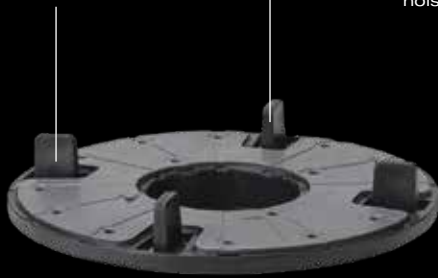

Converter
Perfect Ring



Housing of
Perfect Ring



Screw



Support base

Holes and
canalizations for
the drainage of
water



25/37/B
h. 25-37 mm



37/61/B
h. 37-61 mm



60/105/B
h. 60-105 mm



94/169/B
h. 94-169 mm



150/280/B
h. 150-280 mm



239/320/B
h. 239-320 mm

DOUBLE JOIST INSTALLATION SYSTEM

The aluminium joists system is the ideal solution for the **installation of single-format and multi-format ceramic tiles**. Thanks to this system, the installation is always precise and, at the same time, guarantees great stability and resistance.

Profilpas **double joist system** is composed of two joists in natural aluminium that must be fixed on a special head, thus creating a rail for the positioning of the spacer. The spacer, thanks to its removable tabs, guarantees a correct position of the tiles and creates the 4-mm joint. To avoid the direct contact between tiles and aluminium joists, there is the possibility to attach an adhesive tape of noise-proof rubber on the entire length of the joist or just on some points. This system is suitable for the **installation of ceramic and marble tiles**.



- the double joist system is **not visible from the joint**.
- the double joist system **avoids water stagnation** and the accumulation of dust and filth.
- thanks to the space between the two joists, it is possible to **adjust the height of the support** through the specific key.



PP LEVEL DUO® WITH HEAD FOR DECKING

A **special head suitable for any kind of joist for decking floors**. According to the needed height, it can be used with every base of PP Level Duo® range and, thanks to the converter Perfect Ring, it can be fixed or self-levelling.

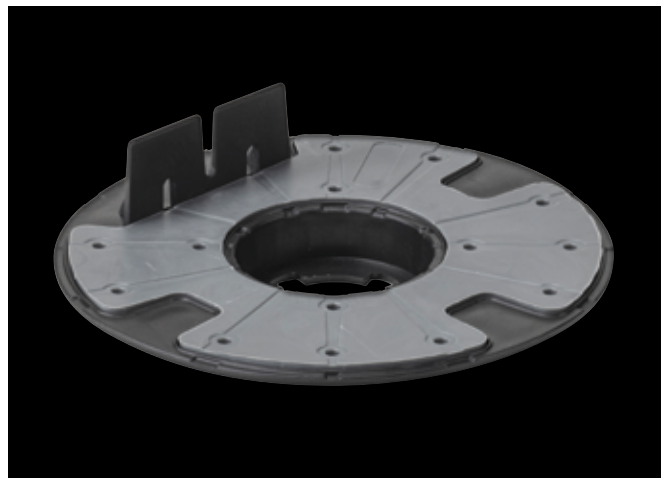



25/37/4



37/61/4



60/105/4



94/169/4



150/280/4



239/320/4



P1/10

PP LEVEL DUO® - BASE + SCREW + HEAD 4 MM

ART.		code	pack	pallet
25/37/4	base + screw + head 4 mm adjustable from h. 25 to 37 mm	19360	25 pcs	1250 pcs
37/61/4	base + screw + head 4 mm adjustable from h. 37 to 61 mm	19361	25 pcs	900 pcs
60/105/4	base + screw + head 4 mm adjustable from h. 60 to 105 mm	19362	25 pcs	500 pcs
94/169/4	base + screw + head 4 mm adjustable from h. 94 to 169 mm	19363	25 pcs	400 pcs
150/280/4	base + screw + head 4 mm adjustable from h. 150 to 280 mm	19364	25 pcs	300 pcs
239/320/4	base + extension + screw + head 4 mm adjustable from h. 239 a 320 mm	19365	25 pcs	300 pcs

no partial packaging

PP LEVEL DUO® - BASE + SCREW

ART.		code	pack	pallet
25/37/B	base + screw adjustable from h. 25 to 37 mm	19390	25 pcs	1250 pcs
37/61/B	base + screw adjustable from h. 37 to 61 mm	19391	25 pcs	900 pcs
60/105/B	base + screw adjustable from h. 60 to 105 mm	19392	25 pcs	500 pcs
94/169/B	base + screw adjustable from h. 94 to 169 mm	19393	25 pcs	400 pcs
150/280/B	base + screw adjustable from h. 150 to 280 mm	19394	25 pcs	300 pcs
239/320/B	base + screw + extension adjustable from h. 239 to 320 mm	19395	25 pcs	300 pcs

no partial packaging

EXTENSIONS FOR PP LEVEL DUO®

ART.		code	pack	pallet
P1/80	extension h. 80 mm	19380	25 pcs	500 pcs
P1/10	extension h. 10 mm	19369	15 pcs	-

no partial packaging

	H. 319/400	H. 399/480	H. 479/560	H. 559/640	H. 639/720	H. 719/800	H. 799/880	H. 879/960	H. 959/1040
art. 239/320/B code 19395 + head to be chosen	1 pc	1 pc	1 pc	1 pc	1 pc	1 pc	1 pc	1 pc	1 pc
art. P1/80 code 19380	1 pc	2 pcs	3 pcs	4 pcs	5 pcs	6 pcs	7 pcs	8 pcs	9 pcs



PPL/T2
PPL/T3
PPL/T4



PPL/TA

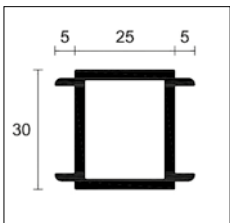

PPL/T



PPL/D4



PPL/GM



PPL/GR



PPL/TT

PP LEVEL DUO® - HEAD FOR 2, 3 AND 4 MM JOINTS

ART.		code	pack	pallet
PPL/T2	head for 2 mm joints	19370	25 pcs	500 pcs
PPL/T3	head for 3 mm joints	19374	25 pcs	500 pcs
PPL/T4	head for 4 mm joints	19371	25 pcs	500 pcs

no partial packaging

PP LEVEL DUO® - HEAD AND ACCESSORIES FOR DOUBLE JOIST SYSTEM

ART.		code	pack	pallet
PPL/TA	head for aluminium joists	19396	25 pcs	500 pcs
PPL/T	aluminium joist L 2000 mm	19397	10 pcs	200 pcs
PPL/D4	4-mm spacer for aluminium joists	19398	500 pcs	-
PPL/GM	noise-proof rubber 20x2 mm - 20 meters roll	19372	5 pcs	-
PPL/GR	connection for joists	19373	250 pcs	-
PPL/TT	T connection for joists	19375	20 pcs	-

no partial packaging

The aluminium joists must be installed in pairs.

PP LEVEL DUO® - TESTA E ACCESSORI PER DECKING

ART.		code	pack	pallet
PPL/TD	head for decking	19399	25 pcs	500 pcs
PPL/5030/T	natural aluminium joist for decking section 50x30x2 mm - length 200 cm	19389	8 pcs	160 pcs
PPL/TD/GR	connection for decking joists	19387	12 pcs	
PPL/TD/TT	T connection for decking joists	19388	20 pcs	

no partial packaging



PPL/TD



PPL/5030/T + PPL/TD/TT



PPL/TD/GR



PPL/TD/TT





PP level FIX

PP level FIX

PP LEVEL FIX, ADJUSTABLE FIXED HEAD SUPPORTS



PP level FIX is a line of **adjustable, fixed-head supports** for self-supporting outdoor raised floors. Available for heights from 25 to 280 mm, PP level FIX supports can be adjusted in height from above through the adjustment key and have a head with tabs for 4-mm joints. They are ideal for floor coverings on flat surfaces or when the floor covering must be parallel to the surface on which the support lays.





25/37/4F



37/61/4F



60/105/4F



94/169/4F



150/280/4F



P1/10

PP LEVEL FIX

testa fuga 4 mm - alette h. 12 mm

ART.		code	pack	pallet
25/37/4F	head + screw + base adjustable from h. 25 to 37 mm	19340	25 pcs	1250 pcs
37/61/4F	head + screw + base adjustable from h. 37 to 61 mm	19341	25 pcs	900 pcs
60/105/4F	head + screw + base adjustable from h. 60 to 105 mm	19342	25 pcs	500 pcs
94/169/4F	head + screw + base adjustable from h. 94 to 169 mm	19343	25 pcs	400 pcs
150/280/4F	head + screw + base adjustable from h. 150 to 280 mm	19344	25 pcs	300 pcs

no partial packaging

EXTENSION FOR PP LEVEL FIX

ART.		code	pack	pallet
P1/10	extension h. 10 mm	19369	15 pcs	-

no partial packaging





PP level MINI

PP level SP

PP level MINI

PP LEVEL MINI, LOW-THICKNESS ADJUSTABLE SUPPORTS (UP TO 30 MM)

PP Level MINI 10/15 is an **adjustable, fixed-head support for heights up to 30 mm**, completing the range. PP Level MINI is height adjustable from 10 to 15 mm, but can be further extended up to 30 mm by inserting a maximum of three P/5 extensions of 5 mm each. PP Level MINI is equipped with easily removable spacer tabs for 4 mm joints.



10/15

PP LEVEL MINI

head for 4-mm joints - tabs h. 10 mm

ART.		code	pack
10/15	adjustable support from h. 10 to 15 mm	19351	20 pcs
P/5	extension h. 5 mm for art. 10/15 (maximum 3 extensions = +15 mm)	19350	20 pcs

no partial packaging



P/5

PP LEVEL SP, FIXED-HEIGHT SUPPORTS

SP1 is a **support with fixed height of 14 mm**. It is the simplest and cheapest solution for installing any self-supporting outdoor flooring. According to the conformation of the subfloor, it can be used with with SP2 (1 mm thick) and SP3 (3 mm thick) levellers.



SP1



SP2

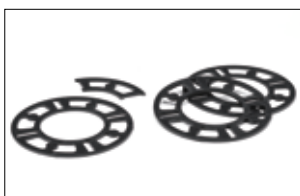

SP3

PP LEVEL SP

pack 360 pcs

ART.			pack	pallet
SP1	fixed height support diam. 155x14 h.	19090	360 pcs	5760 pcs

no partial packaging

PP LEVEL SP - CORRECTOR FOR SP1

pack 1000 pcs

ART.			pack	pallet
SP2	corrector for support SP1 thickness 1 mm	19092	1000 pcs	20000 pcs

conf. 500 pcs

ART.			pack	pallet
SP3	corrector for support SP1 thickness 3 mm	19093	500 pcs	15000 pcs

no partial packaging





**accessories
for
installation**

ADJUSTMENT KEY



Thanks to the special key, PP level DUO MAXI supports with self-levelling head for ceramic floors can be adjusted in height even when the floor is finished, to achieve **perfectly level floors**. For faster adjustment, a steel insert for screwdriver drills is available.

CLIPS FOR VERTICAL CLOSURE



PCC/01

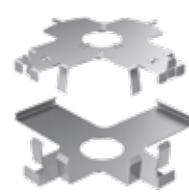

PCC/02



PCC/04
for double joist system

PCC/01 and PCC/02 are two **stainless steel clip** kits (head + base) for **vertical and angular closure** of raised floors with 20 mm thick tiles.

PCC/04 is the **stainless steel clip** kit (head + base) to be used for **vertical closure** in case of raised floors with PP level DUO® double joist system.

PERIMETER SPACERS



PCC/03



PCC/05



PCC/03 and PCC/05 are **two clips, in stainless steel and polypropylene respectively**, both with perimeter spacer function, to obtain uniform and linear joints between the tiles and the perimeter wall.

PERIMETER PROFILES



Protec CPLV-CPLB is a series of **colour-coated aluminium perimeter profiles** for protecting and finishing the outer edges of raised floors.

RUBBER MAT



PPL/S is a **rubber mat** with a diameter of 21 cm and a thickness of 2 mm with **anti-noise function**.

LEVELLING DISK FOR HEAD



PPL/DLT is a **rubber levelling disk** to be placed on the support head to shim one or more sectors and **correct tiles with uneven thicknesses**.

LEVELLING DISK FOR BASE



PPL/DLB is a **rubber levelling disk** to be placed under the support base to shim one or more sectors and **correct any imperfections in the subfloor**.

BATTERY-POWERED VACUUM SUCTION CUP



PPL/V is a **vacuum suction cup with rechargeable battery**, for handling ceramic slabs and with a maximum load capacity of 200 kg.

SLAB LIFTING HANDLE



PPL/MS is an **adjustable slab lifting handle from 39 to 62 cm** for handling and laying ceramic slabs.

TILE LIFTER



PPL/GS is a **tool for lifting already laid slabs** with a minimum joint of 4 mm.

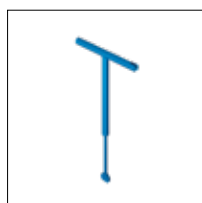

CR/M

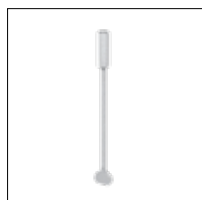

PPL/CT

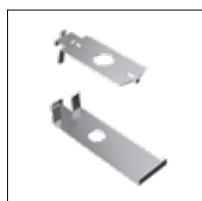

PCC/01

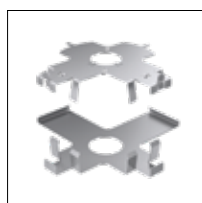

PCC/02



PCC/03



PCC/04



PCC/05



PPL/S



PPL/DLT



PPL/DLB



PPL/V



PPL/MS

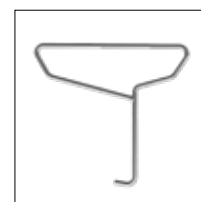

PPL/GS

ACCESSORIES FOR PP LEVEL DUOMAXI - PP LEVEL DUO® - PP LEVEL FIX

ART.		code	pack
CR/M	adjustment key (for 4 mm joints)	19376	12 pcs
PPL/CT	insert for screwdriver drill	19306	1 pc
PCC/01	perimeter clip (base + head)	19382	30 kit
PCC/02	corner clip (base + head)	19383	4 kit
PCC/03	wall clip in stainless steel	19384	50 pcs
PCC/04	perimeter clip for double joist system (base + head)	19386	30 Kit
PCC/05	wall clip in black polypropylene	19377	200 pcs
PPL/S	rubber mat diam. cm 21 x 0,2 thick.	19385	100 pcs
PPL/DLT	levelling disk for head diam. cm 12 x 0,2 thick.	19378	100 pcs
PPL/DLB	levelling disk for base diam. cm 21 x 0,2 thick.	19379	100 pcs
PPL/V	battery-powered vacuum suction cup	19302	1 pc
PPL/MS	slab lifting handle (from 39 to 62 cm)	19304	1 pc
PPL/GS	tile lifter for 4 mm joints	19305	1 pc

no partial packaging (except for CR/M)



PROTEC

length = 270 cm - pack 10 pcs

H

BASE

ART. finishing

20

ALUMINIUM

CPLB natural aluminium

86900

CPLB/2 natural aluminium

86901

CPLB with draining holes available on request. CPLB and CPLB/2 in 15 and 25 mm height available on request. Possibility to choose noise-proof rubber PPL/GM, see page 13

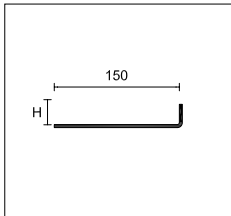
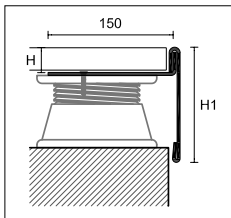

CPLB
base per pavimenti
sopraelevati

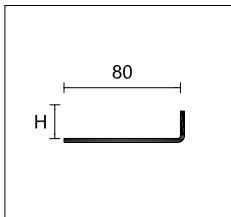

CPLB/2
base tranciata
per pavimenti
a piastrelle

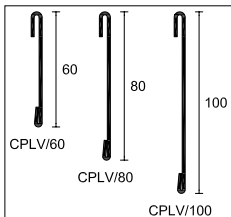

CPLV/

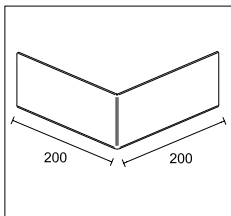

CPLV/ E

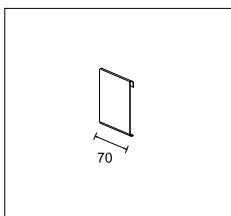

CPLV/ G

PROTEC

length = 270 cm - pack 10 pcs

H1

FRONT

ART. finishing

60

80

100

ALLUMINIO VERNICIATO

ash grey RAL 7038
ancient grey
CPLV/ stone
greige
sand
beige



86902
86903
86908
86911
86914
86917

86904
86905
86909
86912
86915
86918

86906
86907
86910
86913
86916
86919

white RAL 9003, dark brown RAL 8019, metal grey RAL 9006, aluminium grey RAL 9007, ash grey RAL 7038 embossed and rust with a minimum of 270 meters, on request, without surcharge. For other colours please contact our sales department.

OUTSIDE CORNER 90°

pack 5 pcs

H1

ART. finishing

60

80

100

COLOUR-COATED ALUMINIUM

ash grey RAL 7038
ancient grey
CPLV/ E stone
greige
sand
beige



86920
86921
86926
86929
86935
86938

86922
86923
86927
86931
86936
86939

86924
86925
86928
86933
86937
86940

JUNCTION

width = 70 mm - pack 5 pcs

H1

ART. finishing

60

80

100

COLOUR-COATED ALUMINIUM

ash grey RAL 7038
ancient grey
CPLV/ G stone
greige
sand
beige



86930
86941
86944
86947
86950
86953

86932
86942
86945
86948
86951
86954

86934
86943
86946
86949
86952
86955

no partial packaging

POS Material



sample box PP level DUO MAXI 00249

sample box PP level DUO 00038



sample of PP level DUO MAXI - Joist 00241



sample of PP level DUO double joist system 00047



brochure PP level DUO MAXI IT/GB 00299



brochure PP level DUO MAXI IT/GB 00042

general conditions of sale

CONDITIONS OF SALE

These General Conditions shall govern all sales contracts executed between Profilpas S.p.A. and the Buyer and shall prevail on all the Buyer's general or individual purchasing conditions. Any derogation to these General Conditions shall be binding on Profilpas only if accepted in writing by the latter.

1. Prices

The prices shown in Profilpas' price list are in Euro per meter but products will be invoiced in Euro per piece with the discounts granted in accordance with the ordered quantities or upon agreement with Profilpas. Prices are exclusive of additional taxes or customs duties. Profilpas expressly reserves the right to modify the prices without notice, in accordance with any fluctuation in the costs of raw materials.

2. Minimum orders

The required minimum order value is fixed at the amount of Euro 500,00.

3. Orders

Purchase orders must be sent in writing. Orders shall be deemed accepted and binding on Profilpas only after receipt by the Buyer of Profilpas' written order confirmation. Only the discounts and the prices indicated in the order confirmation shall be binding for Profilpas. Should the order confirmation contain amendments with respect to the Order, such amendments shall be deemed tacitly accepted by the Buyer after 5 (five) days from receipt of the order confirmation unless the Buyer notifies its disagreement in writing within the above-mentioned term.

4. Delivery terms

Deliveries shall be made EX WORKS (Incoterms 2010) Profilpas warehouse in Cadoneghe (Padova) - Italy. The products shall always be transported at the Buyer's risk according to the Incoterms, and any reimbursements for damages shall be claimed by the Buyer to the carrier in accordance with the relevant agreements and clauses contained in the stipulated insurance policies. Delivery dates are estimated and not guaranteed.

Profilpas shall not be responsible for any delay nor for the consequences thereof. In case of delay in delivery, the Buyer shall not have the right to terminate the sales agreement and/or obtain compensation of any direct, indirect or consequential damage suffered, unless in case of intent or gross negligence.

5. Packaging

Prices include Profilpas standard packaging. Sea shipment packaging or any other special packaging requested by the Buyer will be charged at cost. Profilpas' catalogue indicates which products have partial packaging and the surcharge applied in such case.

6. Terms of payment

All payments must be made in accordance with the agreed terms of payment; the relevant sums must be transferred to the bank indicated by Profilpas.

In case of delay of payment, whether total or partial, the Buyer shall be bound to pay interest on all outstanding amounts calculated according to art. 5 of Italian Legislative Decree no. 231/2002 or subsequent modifications.

Delay or non-payment of any sums due by the Buyer to Profilpas, even if concerning different contractual relationships, shall entitle Profilpas to suspend the preparation and delivery of the products which are the object of the order and of any other order in progress.

7. Claims

Claims must be notified in writing to Profilpas within 10 days from the delivery date. Claims for damaged, stolen or missing products shall be lodged with the carrier upon receipt of the products. If no written complaint is lodged with the carrier, Profilpas will not accept any return or replacement of the delivered products. Return of products will only be accepted upon Profilpas' prior written consent and always at the Buyer's expense.

8. Retention of title (article 1523 of the Italian Civil Code)

The products shall remain the property of Profilpas until full payment.

Non-compliance, or partial compliance, of the agreed payment terms allow Profilpas, without prejudice to any other claim it may have, to recover the products supplied. The Buyer is liable for any damage to the products due to poor storage or negligence and shall be responsible as a depositary.

Profilpas does not assume responsibility for damage to the products consequential or subsequent to the installation of the same.

9. Warranty and defects

Profilpas guarantees that the products are free from defects in material and workmanship for a period of 12 months from the date of delivery to the Buyer. Should Profilpas acknowledge the existence of the claimed defects, and provided that it has been promptly notified in accordance with the above mentioned paragraph "Claims", Profilpas' warranty shall be limited, at its discretion, to the replacement of the defective products, free of charge EXW Profilpas' premises (Incoterms 2010), within the normal time required therefor, or to the issue of a credit note for the amount of the defective products, ANY OTHER LEGAL OR

CONVENTIONAL WARRANTY OR CLAIMS FOR ANY FURTHER DIRECT, INDIRECT OR CONSEQUENTIAL DAMAGES SUSTAINED BY THE BUYER OR THIRD PARTIES, UNLESS IN CASE OF INTENT OR GROSS NEGLIGENCE OR IN CASES OF MANDATORY LEGAL REQUIREMENTS, BEING EXPRESSLY EXCLUDED.

The Buyer expressly waives its right of regress according to article 134 of the Italian Consumers' Code.

No products will be returned by the Buyer without prior written permission by Profilpas. Profilpas does not guarantee the compliance of the products to any particular specifications or technical characteristics or their suitability for any use and/or special uses if not to the extent that such characteristics have been expressly agreed in the sales contract.

Profilpas is not liable for damages that the Buyer, or third parties, generate by using the products if the damage does not depend on the quality or intrinsic characteristics of the product, but by the choice of purchase and usage of the same by the Buyer.

10. Industrial and intellectual property

Profilpas Spa's trademarks, distinguishing signs, designs, photographs of products and/or production and commercial technology shall be considered strictly confidential and shall not be used without prior written authorization from the same.

11. Express delivery

Upon the Buyer's request, Profilpas can offer a service of express delivery.

The surcharge for this express service will be communicated with the order confirmation.

12. Privacy

The parties undertake to comply with the laws - including EU Regulation 2016/679 "General data protection regulation" or "GDPR" - on the protection and processing of personal data that may apply to the relationships between the Parties pursuant to this agreement and assume the qualification as "data controller" in relation to the personal data acquired in the performance of this agreement. The parties declare that they have security devices and systems which are appropriate for the protection of the personal data in their possession, including the personal data acquired hereunder, against risks of destruction or loss, also accidental, unauthorized access, processing not allowed or not consistent with the purpose of the data collection.

13. Final clauses

Profilpas sales are governed by the laws of Italy. In case of dispute, the courts of Padua - Italy shall be the exclusive competent venue.

Index by item

10/15	34
150/280/4	26
150/280/4F	31
150/280/B	26
239/320/4	26
239/320/B	26
25/37/4	26
25/37/4F	31
25/37/B	26
37/61/4	26
37/61/4F	31
37/61/B	26
60/105/4	26
60/105/4F	31
60/105/B	26
94/169/4	26
94/169/4F	31
94/169/B	26
CPLB	43
CPLB/2	43
CPLV/	43
CPLV/ /E	43
CPLV/ /G	43
CR/M	42
L/56/91/4	12
L/56/91B	12 - 17
M/38/57/4	12
M/38/57B	12 - 17
P/5	34
P1/10	12 - 17 - 26 - 31
P1/80	26
P1/80TE	12 - 17
PCC/01	42
PCC/02	42
PCC/03	42
PCC/04	42
PCC/05	42

PPL/5030/T	13
PPL/CT	42
PPL/D4	13 - 27
PPL/DLB	42
PPL/DLT	42
PPL/GM	27
PPL/GM200	13
PPL/GM50	13
PPL/GR	27
PPL/GR1	13
PPL/GS	42
PPL/MS	42
PPL/S	42
PPL/T	27
PPL/T1	13
PPL/T2	27
PPL/T3	27
PPL/T4	27
PPL/TA	27
PPL/TD	27
PPL/TD/GR	13 - 27
PPL/TD/TT	13 - 27
PPL/TT	27
PPL/V	42
PPLM/T2	13
PPLM/T3	13
PPLM/T4	13
PPLM/T4F	17
PPLM/TA	13
PPLM/TD	13
S/28/39/4	12
S/28/39B	12 - 17
SP1	35
SP2	35
SP3	35
XL/87/150/4	12
XL/87/150B	12 - 17



Profilpas S.p.A.

Registered office:

Viale E. Jenner, 4
20159 Milano (MI) Italy

Head office and plant:

Via Einstein, 38
35010 Cadoneghe (PD) Italy

Customer Service Italia: +39 049 8878411
Customer Service Export: +39 049 8878412

info@profilpas.com
profilpas.com

